

CHAPTER 5
PO X05 – PARTICIPATE IN PHYSICAL ACTIVITIES



**COMMON TRAINING
ALL TRAINING LEVELS
INSTRUCTIONAL GUIDE
PHYSICAL ACTIVITIES**



SECTION 1

EO MX05.01 – PARTICIPATE IN PHYSICAL ACTIVITIES

Total Time:

3 sessions (9 periods) = 270 min

PREPARATION

PRE-LESSON INSTRUCTIONS

This IG supports EO MX05.01 (Participate in Physical Activities) located in A-CR-CCP-801/PG-001, *Royal Canadian Air Cadets Proficiency Level One Qualification Standard and Plan*, Chapter 4.

Refer to the warm-up and the cool-down located at Annexes A and B of EO MX04.01 (Participate in 60 Minutes of Moderate- to Vigorous-Intensity Physical Activity and Track Participation in Physical Activities).

Select a physical activity to conduct.

Gather the required equipment as per the selected activities.

Assistant instructors / specialists may be required based on the activity selected.



Suggested physical activities are located at the attachments to this IG as follows:

Cardiovascular Activities, including:

- Attachment A - Aerobics,
- Attachment B - Cross-Country Skiing,
- Attachment C - Hiking,
- Attachment D - Ice Skating,
- Attachment E - Instructor-Led Dancing,
- Attachment F - Orienteering,
- Attachment G - Rollerblading,
- Attachment H - Running,
- Attachment I - Skipping Rope,
- Attachment J - Snowshoeing, and
- Attachment K - Swimming.

Muscular Strength Activities, including:

- Attachment L - Muscular Strength Exercises using the Body, Balance Balls, Resistance Bands, and Weighted Balls and Bars,
- Attachment M - Pilates,

Muscular Flexibility Activities, including:

- Attachment N - Stretching,
- Attachment O - Tai Chi, and
- Attachment P - Yoga.

Recreational Team Sports, including:

- Attachment Q - Baseball,
- Attachment R - Basketball,
- Attachment S - Floor Hockey,
- Attachment T - Football (Flag or Touch),
- Attachment U - Lacrosse,
- Attachment V - Ringette,
- Attachment W - Soccer,
- Attachment X - Soccer Baseball,
- Attachment Y - Softball,
- Attachment Z - Ultimate Frisbee, and
- Attachment AA - Volleyball.

Other Physical Activities, including:

- Attachment AB - Active Games,
- Attachment AC - Circuit Training,
- Attachment AD - Martial Arts, and
- Attachment AE - Tableids.

PRE-LESSON ASSIGNMENT

Nil.

APPROACH

A practical activity was chosen for this lesson as it allows the cadets to participate in physical activities in a safe and controlled environment.

INTRODUCTION

REVIEW

Nil.

OBJECTIVES

By the end of this lesson the cadet shall be expected to have participated in physical activities.

IMPORTANCE

It is important for cadets to participate in physical activities to identify activities that are fun and to promote lifelong participation in physical activity.

Teaching Point 1

Have the cadets participate in physical activities.

Time: 9 x 30 min

Method: Practical Activity

ACTIVITY

OBJECTIVE

The objective of this activity is to provide the cadets an opportunity to participate in physical activities.

RESOURCES

- Equipment / safety equipment required for the selected physical activity, and
- First aid equipment.

ACTIVITY LAYOUT

Activity layout will depend on the selected physical activity.

ACTIVITY INSTRUCTIONS

1. Introduce the selected physical activity, to include:
 - (a) which component(s) of fitness are improved through participation in the selected physical activity, and
 - (b) techniques for participating in the selected physical activity.
2. Have the cadets participate in a safety briefing, to include:
 - (a) rules / regulations of the selected physical activity,
 - (b) requirement for safety equipment for the selected physical activity,
 - (c) location of first aid post, and
 - (d) boundaries or route information.
3. Have the cadets participate in a warm-up session as per Annex A of EO MX04.01 (Participate in 60 Minutes of Moderate- to Vigorous-Intensity Physical Activity and Track Participation in Physical Activities).
4. Have the cadets participate in the selected physical activity.
5. Have the cadets participate in a cool-down session as per Annex B of EO MX04.01 (Participate in 60 Minutes of Moderate- to Vigorous-Intensity Physical Activity and Track Participation in Physical Activities).

SAFETY

- Ensure constant supervision throughout the activity.
- Ensure a first aid post / kit is readily accessible.
- Ensure a first-aider is identified at the start of the activity and is available at all times.
- Ensure cadets remain hydrated throughout the activity.

CONFIRMATION OF TEACHING POINT 1

The cadets' participation in the physical activity will serve as the confirmation of this TP.

END OF LESSON CONFIRMATION

The cadets' participation in the physical activity will serve as the confirmation of this lesson.

CONCLUSION

HOMEWORK / READING / PRACTICE

Nil.

METHOD OF EVALUATION

Nil.

CLOSING STATEMENT

Participating in physical activities can help you:

- improve your health;
- do better in school;
- improve your fitness;
- grow stronger;
- have fun being active with friends;
- feel happier;
- maintain a healthy body weight;
- improve your self-confidence; and
- learn new skills.

INSTRUCTOR NOTES / REMARKS

The aim of this lesson is for cadets to have fun participating in physical activities. Choose activities the cadets will enjoy. Survey cadets to determine those physical activities in which they are interested.

Several physical activities may be conducted concurrently. Choice is an important factor when it comes to enjoying physical activity. The more varying types of physical activities cadets are exposed to, the more likely they are to find an activity they will be interested in pursuing on a regular basis.

Choose activities based on human and material resources accessible to the corps / squadron.

Fitness videos (conducted by a certified trainer), certified trainers and Canadian Forces Personnel Support Programs (PSP) staff may be used to conduct this training.

Activities chosen for this training are not limited to the lists presented above but must be age appropriate, safe, and in-line with the aim of promoting physical fitness.

Physical activity periods may be conducted consecutively to provide the cadets an opportunity to participate in longer, varied physical activities.

REFERENCES

- About Ultimate. (2006). *About ultimate*. Retrieved October 30, 2006, from <http://www.upa.org/ultimate>
- Alberta Centre for Active Living. (2007). *What should parents know about strength training for youth ages 12 to 17?* Retrieved October 4, 2011 from <http://www.centre4activeliving.ca/our-work/faq/strength-train.pdf>
- Anderson, B. (2000). *Stretching: 20th anniversary* (Rev. ed.). ISBN 0-936070-22-6. Bolinas, CA: Shelter Publications, Inc
- Bagshaw, C. (Ed.). (2006). *The ultimate hiking skills manual*. ISBN 978-0-7153-2254-3. Cincinnati, OH: David & Charles
- Berger, K. (2005). *Backpacking & hiking*. ISBN 0-7566-0946-1. New York, NY: DK Publishing, Inc
- Body Bar. (2010). *Programs & education*. Retrieved October 5, 2011, from <http://www.bodybar.com/Programs-Education>
- Canadian Orienteering Federation (1983). A-CR-CCP-151/PT-001 *Orienteering Level 1 Coaching Certification*. National Coaching Certification Program, Canadian Orienteering Federation.
- Canadian Orienteering Federation (1985). *Orienteering Level Two Coaching Certification*.
- Chapman, J.R. Major, M.B.E. (1968). A-CR-CCP-150/PT-001 *Orienteering: an Aid to Training*. London, England: Hillside Printing & Publishing Co.
- Corbin, C., & Lindsey, R. (2007). *Fitness for life: Updated fifth edition*. ISBN 978-0-7360-6675-4. Windsor, ON: Human Kinetics
- Curtis, R. (2005). *The backpacker's field manual: A comprehensive guide to mastering backcountry skills*. ISBN 1-4000-5309-9. New York, NY: Three Rivers Press
- Director Cadets 3. (2006). A-CR-CCP-951/PT-002. *Royal Canadian Army Cadets adventure training safety standards*. Ottawa, ON: Department of National Defence.
- Faigenbaum, A. Ed. & Micheli, L. (1998). *Youth strength training*. Retrieved October 4, 2011, from http://www.acsm.org/AM/Template.cfm?Section=Current_Comments1&Template=/CM/ContentDisplay.cfm&ContentID=8657
- Graydon, D., & Hanson, K. (Eds.). (2001). *Mountaineering: The freedom of the hills* (6th ed.). ISBN 0-89886-427-5 Seattle, WA: The Mountaineers
- Hanlon, T. (1998). *The sports rules book: Essential rules for 54 sports*. ISBN 0-88011-807-5. USA: Human Kinetics Publishers, Inc.
- International Orienteering Federation (2006). Retrieved 20 April 2006, from <http://www.orienteering.org/footer/pictsymb.htm>.
- Kjellstrom, B. (1994). *Be Expert With Map & Compass: The Complete Orienteering Handbook*. ISBN 0-02-029265-1. New York: Hungry Minds, Inc.
- LeBlanc, J., & Dickson, L. (1997). *Straight talk about children and sport: Advice for parents, coaches, and teachers*. ISBN 0-88962-630-8. Oakville, ON: Mosaic Press.
- Livestrong.com. (2011). *Beginner's Pilates exercises*. Retrieved October 4, 2011, from <http://www.livestrong.com/article/452265-beginner-pilates-exercises/>
- Lose the Back Pain (2006). Retrieved April 25, 2006, from www.losethebackpain.com

- Men's Health. (2011). *The 5-minute six-pack abs*. Retrieved October 5, 2011, from <http://www.menshealth.com.sg/fitness/5-minute-six-pack-abs>
- Norris, G. (Ed.). (1998). *National Football Federation: Touch football rule book 2004*. Ottawa, ON: National Football Federation
- Panicucci, J. (2008). *Achieving Fitness: An Adventure Activity Guide*. ISBN 0-934387-29-X. Beverly, MA: Project Adventure, Inc
- Popovic, Srdjan. (2011). *10 Skipping Rope Exercises for a Better Body*. Retrieved October 6, 2011, from <http://www.bloomtofit.com/10-skipping-rope-exercises-for-a-better-body>
- Ringette Canada. (2006). *How ringette is played*. Retrieved October 30, 2006, from <http://www.ringette.ca/e/about/played.htm>
- Roadcycling (2006). Retrieved April 25, 2006, from www.roadcycling.com/artman/upload/stretch.es.jpg
- Shelter Online (2006). Retrieved April 25, 2006, from www.shelterpub.com/_fitness/online_stretches.gif
- Spine Universe. Retrieved April 25, 2006, from www.spineuniverse.com
- Sports fitness advisor. (n.d.). *Medicine ball exercises*. Retrieved October 5, 2011, from <http://www.sport-fitness-advisor.com/medicine-ball-exercises.html>
- Stott, W. (1987). *Armchair Orienteering II: A Practical Guide to Route Planning*. Winnipeg: Manitoba Orienteering Association.
- What is Ultimate Frisbee? (2006). *What is ultimate – the game*. Retrieved October 30, 2006, from http://www.whatisultimate.com/what/what_game_en.html
- Waehner, P. (n.d.). *Resistance band workout for beginners*. Retrieved October 5, 2011 from <http://exercise.about.com/library/bltotalresistancebeginners.htm>
- Walkablock Club of America (2005). Retrieved April 25, 2006, from www.walkablock.com/stretch2.gif
- Women's Heart Foundation (1999-2000). Retrieved April 25, 2006, from www.womensheart.org/content/Exercise/stretching_exercise.asp

THIS PAGE INTENTIONALLY LEFT BLANK

AEROBICS

INTRODUCTION

Aerobic exercise is physical exercise of relatively low intensity and long duration, which depends primarily on the aerobic energy system.

EQUIPMENT

The equipment required will vary based on the selected type of aerobic activity.

ACTIVITY GUIDELINES

Aerobic activities shall be tailored to accommodate a variety of fitness levels. Encourage cadets to participate at their highest level to fully maximize the benefits of aerobic activities.

EXAMPLES OF AEROBIC ACTIVITIES

Step Exercises. Step exercises usually involve an elevated step that the participant steps on and off of. Intensity can be increased by increasing movement speed or the height of the step being used.

Exercise Equipment. Exercise equipment can be used to provide individual aerobic training or in organised classes such as spin class (a group class that uses exercise bikes). Examples include exercise bikes, elliptical trainers, rowing machines, step machines, and treadmills.

Jazzercise. Jazzercise was created in 1969 by Judi Sheppard Missett. It combines aspects of dance with resistance training, Pilates, yoga, and kickboxing. Jazzercise is ranked one of the top fitness programs in the world with over 7800 instructors in 38 countries.

Tae Bo. Made popular in the 1990s, Tae Bo is an exercise routine that uses martial arts at a quick pace to increase the heart rate. It was developed by Billy Banks, an actor turned fitness consultant.

SUGGESTED RESOURCES

Judi Sheppard Missett, Certified Jazzercise Instructor. *Jazzercise Core: Target & Tone Muscle, Fat Burning, Strength Building*. 2009. [DVD]

Judi Sheppard Missett, Certified Jazzercise Instructor. *Jazzercise: Live*. 2008. [DVD]

Billy Banks, Certified Tae Bo Instructor. *This is Tae Bo*. 2010. [DVD]

Billy Banks, Certified Tae Bo Instructor. *Cardio Explosion*. 2010. [DVD]

THIS PAGE INTENTIONALLY LEFT BLANK

CROSS-COUNTRY SKIING

INTRODUCTION

Cross-country skiing is a sport that requires very little skill. However, understanding stroke mechanics and techniques will make skiing more efficient and enjoyable.

EQUIPMENT

Skis. The chart below is a rough guide to follow when selecting a ski length.

Ski Length	Carrying Capacity
168 cm	90–130 lb
168, 178 cm	130–150 lbs
178, 188 cm	150–180 lbs
188 cm	180–220 lbs

Ski Boots. Skis are guided and controlled through the boots, so it is important that they fit well. Boots are made from a variety of materials, from all leather to modelled plastic to a combination of materials. Lighter boots provide more freedom but offer less support. Heavier boots provide more support but usually restrict movement and are harder to fit. Boots that are too tight / loose may cause the skier incredible discomfort and may result in injuries such as blisters.

Ski Poles. Ski poles are an integral part of cross-country ski equipment. Most techniques in cross-country skiing require the skier to not only use their skis, but their arms (poles) as well. Ski poles help the skier maintain balance while climbing inclines, when going downhill and when going forward.

ACTIVITY GUIDELINES

Cross-country skiing shall be limited to new fallen snow, powder snow, and wind-packed snow. It shall also be conducted on novice / beginner trails.

New Fallen Snow. Very loose and light. The snowflakes still have multiple branches. If new snow is dry, it is feathery; if damp, it quickly consolidates into a stage of settled snow.

Powder Snow. New, untouched freshly fallen soft snow. It can give the feeling of floating in a weightless environment. Powder snow can be packed in thick layers that form a natural pillow. Powder snow has a low moisture content, as almost 97 percent of it is air.

Wind-Packed Snow. Snow blown from one direction, compacted by the force of the wind. Wind-packed snow is created by the pressure exerted by wind, causing a form of cold-heat hardening.

The following types of snow should be avoided when conducting cross-country skiing:

Sun Crust Snow. Snow that has had the upper layer melt and then refreeze. Usually on top of powder snow, sun crust snow is stronger than the powder snow below it due to the refreezing. This snow can be dangerous to cross-country ski on if on a slope; the crust may give way and a person may lose their footing. Cross-country skiing on a flat surface over sun crust snow can be difficult as the skis break through the crust and can hook into the crust on the return. The constant hooking and breaking in sun crusted snow can quickly tire the cross-country skier.

Corn Snow. Corn snow occurs after thawing, usually in the spring. It is produced during the cycle of melting and refreezing in the accumulated snow. The structure of the snow is very grainy. Corn snow can be strong enough to carry weight, but can also indicate the presence of rotten snow, which is very dangerous.

Rotten Snow. Caused by repeated melting and freezing and is found mostly on the south side of hills, or in lower levels of snow. Water will seep to the lower layers and will not freeze because it is insulated from the weather by the covering snow layer. Rotten snow can resemble very small icicles, or candle ice. This snow is dangerous. Sudden drops and holes may exist under the surface of the snow. Falling and injury are highly possible.

Slush Snow. When the air temperature becomes warmer than the freezing point, the snow begins to melt and the water content becomes high. Slush snow absorbs water from melting snow. Slush snow is recognizable by depressions in the snow with darker or bluish snow areas. These areas show holes in the ice or an accumulation of water on the surface of the ice.

CROSS-COUNTRY SKIING TECHNIQUES

Falling Down

Falling down is a common occurrence when cross-country skiing. It is not the falling that is difficult when cross-country skiing; getting up after the fall is what most struggle with.

When losing balance and about to fall:

1. Check the area for rocks or tree stumps to avoid, if possible.
2. Sit down to one side or the other of the skis.
3. Keep the legs below the rest of the body.
4. Dig the skis into the snow to stop any forward momentum.

To get up after a fall:

1. Roll onto the back and stick legs, arms, skis and poles into the air to untangle them.
2. Bend the knees and place the skis flat on the ground, concurrently sliding the hips towards the feet and the backs of the skis under the behind.
3. Come to one knee (plant the poles at the sides to assist).
4. Stand up.

Stopping

For their own safety and for the safety of those around them, it is extremely important that cadets are able to slow down and stop themselves on flat ground and on hills. The principles for both are the same and require the cadet to have constant control of their body and their skis. A cross-country ski glides most effectively when it is flat on the ski base. A ski begins to lose forward momentum as soon as it is tipped to either edge.

Therefore, to stop, the skier must tip the ski to the edge—this is called edging.



The wedge position is sometimes referred to as the snowplow position. Some may be more familiar with this term as it is also used in downhill skiing.

There are two types of wedging:

- the half wedge, and
- the full wedge.

To slow down / stop using the half wedge:

1. Decide which ski to move into the half wedge position.
2. Keep the skis parallel to each other.
3. Move into the half wedge position by:
 - (a) bringing the knees together;
 - (b) keeping the tips of the skis together; and
 - (c) moving the tail of the desired ski outward by pushing the heel out and the toes inward.
4. Angle the inside edge of the wedged ski into the snow by rolling the ankle inward (the more the edge is angled into the snow, the faster the skier will slow down / stop).

To slow down / stop using the full wedge:

1. Sink into a crouch.
2. Bring the knees together and point them toward the tips of the skis.
3. Keep the tips of the skis together (but not touching).
4. Move the tails of the skis outward by pushing the heels outward and the toes inward.
5. Angle the inside edges of the skis into the snow by rolling the ankles inwards (the more the edge is angled into the snow, the faster the skier will slow down / stop).

Changing Direction

Whenever on cross-country skis there is always a requirement to change direction of travel. It is a fairly simple process that requires practice in order to perfect.

Changing direction can be carried out by picking up the tip, the tail or the entire ski, one at a time, and moving it toward the new direction of travel—then repeating the process with the other ski. Depending on the degree of the turn, the skier may need to complete this process a number of times before reaching the desired direction.

To change direction:

1. Assume the half-sitting position.
2. Move the left (right) ski forward until the left (right) boot toe is just ahead of the right (left) boot toe.
3. Lift the tip of the left (right) ski about 30 cm (1 foot) off the ground.
4. Move the lifted ski slightly to the left (right), about an arc of 30 degrees.
5. Place the left (right) ski on the ground and transfer the weight to it.
6. Bring the right ski around, in the same manner, to meet the left ski.
7. Repeat Steps 2–6 until facing the desired direction.

Poling

There are two different poling techniques that a cross-country skier can use, to include:

Diagonal Poling. Uses the pole opposite of the gliding ski to create additional forward motion of the skier. The skier plants and pushes with only one pole at a time.

Double Poling. Simultaneously uses both poles to propel the skis and skier forward. Used to go down gentle slopes in order to gain speed and on flats when the skier is not using the diagonal stride.

The following poling principles should be considered:

- Poles cannot push forward unless they are angled to the rear.
- The skier gets a stronger push when their arms are bent rather than straight.
- Pushing the pole back rather than down converts more of the skier's energy into forward motion at the end of a stroke.
- The skier should use their body weight, not just their arms, and pull with their core to move forward.

To diagonal pole:

1. Assume the half-sitting position.
2. Move the left ski so that it is forward of the right ski.
3. Lean forward.
4. Transfer the weight to the left ski.
5. Plant the right pole just ahead of the left ski boot (to the right of the path that the right ski will take).
6. Simultaneously push off with the left ski and push the right pole.
7. Recover by lifting the left pole.
8. Repeat the process with the other pole.

To double pole:

1. Assume the half-sitting position.
2. Keep the elbows close to the body.
3. Lean forward to round the back.
4. Plant the poles just ahead of the ski boots.
5. Contract the abdominal muscles.

6. Push forward and extend the arms back.
7. Stand up.
8. Allow the arms and poles to swing forward.
9. Prepare for the next pole plant.

Executing the Diagonal Stride

When cross-country skiing, the most frequently used technique to move forward is by executing the diagonal stride. It is called the diagonal stride because the right leg and the left pole (and vice versa) work together to move the skier forward. The diagonal stride technique makes for greater forward thrust and easy balance.

Ascending Hills

The biggest factor that affects a skier's ability to traverse up a hill is grip. Grip comes from the skier staying over their feet and pushing their skis straight down into the snow. There are two different techniques that can be used to ascend hills: herringbone and side step.

Herringbone. A technique used to climb straight up a hill on the inside edges of the skis with the tips farther apart than the tails. A skier using the herringbone technique to ascend a hill leaves an imprint that resembles the skeleton of a fish.

To use the herringbone technique to ascend a hill:

1. Place skis into a 'V' formation with the tails close together.
2. Turn the legs out.
3. Transfer the weight onto the left (right) foot.
4. Lift up the right (left) ski and move it forward.
5. Plant the left (right) pole behind the left (right) ski.
6. Repeat until reaching the top of the hill.

Side step. A technique where the skier places their skis horizontal to the hill and moves upward using short side steps. A skier uses the side step when a hill gets too steep, the snow becomes too deep, or the herringbone becomes too tiring.

To use the side step technique to ascend a hill:

1. Place the skis horizontal to the hill to be ascended.
2. Keep the body upright and centred over the skis.
3. Move the torso sideways and up the hill.
4. Plant the pole ahead of them.
5. Lift and move the ski up.
6. Dig the edge of the ski into the snow.
7. Repeat until the top of the hill is reached.

Descend a Hill

The most important factors to descending a hill safely are balance and control. A skier should never just turn their skis downhill and go—the descent must always be controlled. In other words, the skier must always be ready to slow down or stop.

When descending a hill:

1. Adopt the half-sitting position.
2. Keep the head up and look forward.
3. Move the skis so that they are just under shoulder-width apart.
4. Ensure the feet are flat on the skis.
5. Look down the slope to make sure there are no obstacles.
6. Drop the hands to thigh level.
7. Hold the pole shafts toward the back, keeping the tips off the snow.
8. Glide down the hill.
9. Slow down / stop by executing a full wedge.

SUGGESTED RESOURCES

ISBN 0-88011-652-8 Gaskill, Steven. (1998). *Fitness cross-country skiing*. Windsor, ON: Human Kinetics.

HIKING

INTRODUCTION

Hiking is an activity of vigorous walking in the outdoors / wilderness on an unpaved trail, either on a path or navigating along an unmarked route. It offers an alternative learning environment and allows cadets to explore the outdoor surroundings. The level of challenge can be adjusted by varying the location / terrain of the hikes.

EQUIPMENT

Water Carrier. Carrying water during a hike requires a lightweight water bottle with a tight lid that is easily refillable. Choose a water bottle that can withstand the temperatures of frozen or hot liquids.

Extra Food. It is always advisable to bring extra food on a hike. Snacks such as granola bars, GORP (good old raisins and peanuts), chocolate bars, and dried fruit will provide the hiker with an energy boost. In an emergency situation they may also increase chances of survival.

Extra Clothing. Extra clothing includes an additional layer of warm clothing and a rain coat. A light down vest, sweater, or fleece jacket will provide insulation should the weather be cooler than expected, and during breaks when sweat evaporates and the body cools. Rain coats may also be used in building a shelter in an emergency situation.

Sunscreen. The skin will burn when the amount of exposure to the sun, or ultraviolet light source, exceeds the ability of the body's protective pigment to protect the skin. According to the Canadian Dermatology Association a minimum of SPF 15 with UV-A and UV-B protection should be worn.

Sunglasses. Hikers should always wear sunglasses to protect their eyes against damage from the sun's light. This is especially important in the winter, as snow blindness is a prevalent injury.

Hat. A wide-brimmed hat will protect the back of the neck, ears, and face from burning. A toque in the winter will keep the hiker's ears warm and stop the escape of heat from the head.

Insect Repellent. Mosquitoes and black flies can spread disease and have a negative impact on a hike. Wear loose-fitting clothing with closed cuffs and apply insect repellent to ward off unwanted insects.

Survival Kit. Having a survival kit is a must during any hiking trip. It should include water purification tablets, a light source, waterproof matches, a signalling device and first aid materials.

Notebook and Pencil. Having a notebook and pencil will allow cadets to keep a log of the hike, such as route details, trail condition, trail difficulty, and general observations. This will provide the cadets with beneficial information for planning other hikes. It will also provide a record of the experience.

ACTIVITY GUIDELINES

Terrain Difficulty

A-CR-CCP-951/PT-002, *Royal Canadian Army Cadets Adventure Training Safety Standards*, uses the Yosemite Decimal System (YDS) to rate trail difficulty levels. YDS has a scale from 1–5 and it rates the hardest / most technical section on a terrain / route. It also provides ratings for travel over flat terrain.

Class 1. Hiking, usually on a trail.

Class 2. Simple scrambling, crossing obstacles with the occasional use of hands, requires route-finding skills, may be backcountry dense bush.

Class 3. Angle is steep enough that hands are required for balance; scrambling on rocks using hands and feet, a rope might be carried.

Class 4. Simple climbing, often with exposure requiring a rope belay. A fall could be serious or fatal. Natural protection can usually be easily found.

Class 5. Technical rock climbing begins. Climbing involves the use of ropes, belays, and the placement of natural or artificial protection for the leader in case of a fall. An open-ended decimal extension to Class 5 exists for rating climbs within this category.

Types of Terrain

Easy Terrain. Terrain is flat and footing is secure. Forest roads, trails following streams and rolling hills are generally easy walking.

Moderate Terrain. Terrain with a trail that is mostly solid under foot with either one fairly steep hill or a series of small hills or forest floors with light underbrush.

Difficult Terrain. Any terrain in which a person ascends or descends over 150 m in 1 km. It can also consist of patches of dense forests, thick vegetation and rocky trails / root-covered trails.



Terrain for this activity shall be limited to Class 1 terrain difficulty, and to Easy or Moderate type of terrain.

HIKING TECHNIQUES

An average day of hiking will consist of periods of hiking and periods of rest. The combination of good hiking rhythm, hiking speed, and fixed rest intervals separate beginners from experienced hikers. Enthusiasm often tends to cause one to start too fast, get tired quickly, take an early rest, and start off too fast again.

Stride Rhythm and Speed

A steady hiking rhythm is generally more enjoyable as one over-exerts themselves less and keeps the physical strain at comfortable levels. Having a steady rhythm will enable the cadets to stick to a fixed schedule and lessen the strain put on the body.

Developing a Hiking Rhythm

A hiking rhythm is very personal and is developed over the course of many hikes. Here is how:

- Choose a specific stride rhythm and speed and keep to it. A good rhythm is one that allows the cadet to hike at the same intensity level for at least one hour without having to take a break.
- Adjust rhythm to terrain, weather and weight. The point where a cadet can no longer carry on a conversation indicates that they have gone beyond a comfortable rhythm.
- Make the rhythm a full-body movement where breathing and swinging of the arms happen in harmony. Uneven surfaces (eg, uphill / downhill) can make it difficult to maintain a steady rhythm.

Controlling Fatigue

The purpose of resting is to slow down the heart rate and breathing. Resting gives the body time to get rid of the lactic acids built up in muscles, and to recover from hot spots or sores.

Resting guidelines:

- Rest in regular intervals; try 10 minutes for every hour hiked (make them part of the rhythm). 10 minutes is the most effective rest duration for body recovery.
- Take off backpacks, rest in the shade, and sit down during rests.
- Use only lunch and dinner (supper) breaks as extended rest periods. During these extended breaks, allow feet to rest and dry by removing shoes, and airing out footwear.

Full Body Synchronization

Hiking rhythm is a full body affair. Just like marching, hiking requires coordinated movements where every action has a reaction. The swinging of arms provides momentum, breathing controls pace, etc. To properly control rhythm, one must first learn what body parts work in unison. To employ full body synchronization during hiking, the arms should be in motion at a natural swing, opposite the forward foot.

SUGGESTED RESOURCES

ISBN 0-7566-0946-1 Berger, K. (2005). *Backpacking & hiking*. New York, NY: DK Publishing, Inc.

ISBN 978-0-7153-2254-3 Bagshaw, C. (Ed.). (2006). *The ultimate hiking skills manual*. Cincinnati, OH: David & Charles.

THIS PAGE INTENTIONALLY LEFT BLANK

ICE SKATING

INTRODUCTION

Ice skating increases the body's flexibility and endurance with very low impact. It boosts the cardiovascular system while also improving balance and agility.

EQUIPMENT

- Helmets, and
- Ice skates.

ACTIVITY GUIDELINES

Ice skating shall be conducted at an established ice skating venue such as an ice rink.

ICE SKATING TECHNIQUES

Walking. Many rinks will have a rubber mat on which the cadets can practice walking in skates. When walking in skates, it is recommended to have the skate guards on the ice skates.

First Time on Ice. Have the first-time ice skaters move along the ice around the perimeter, so they can use the walls for support. There may be skating aids available to new ice skaters.

Practice falling. If a fall is anticipated, bend the knees and squat. When falling, hands should be quickly clenched into a fist to minimize the risk of injury from passing skaters.

Getting Up. To get up, ice skaters should get on their hands and knees and place one foot between their hands. Repeat with the other foot and lift up to the standing position.

Moving. To move, ice skaters should lean on their weak leg, and then push in a diagonal direction outwards with the strong leg, pretending they are shovelling snow behind and to the right.

Stopping. To stop, bend the knees slightly inward and then push out with one or both feet. This creates pressure on the ice causing the feet to not slide out.

SUGGESTED RESOURCES

Nil.

THIS PAGE INTENTIONALLY LEFT BLANK

INSTRUCTOR-LED DANCING

INTRODUCTION

Dancing is a social activity that encourages the development of cardiovascular endurance as well as developing strength and flexibility. The intensity of the dance can be modified to accommodate varying levels of fitness as well as ability.

EQUIPMENT

Equipment will vary depending on the selected type of dance.

ACTIVITY GUIDELINES

Dancing shall be structured, well supervised and conducted by a certified instructor or using a video that is conducted by a certified instructor.

This activity shall not be conducted as a social cadet dance.

SUGGESTED TYPES OF DANCE

- Foxtrot,
- Highland Dancing,
- Hip Hop,
- Jitterbug (Swing),
- Line Dancing,
- Salsa, and
- Waltz.

SUGGESTED RESOURCES

Jennifer Galardi. Certified Fitness Instructor. *Dance off the inches: Hip hop party*. 2007. [DVD]

Kristina Milova. Certified Fitness Instructor. *Dance off the inches: Dance it off ballroom*. 2008. [DVD]

Amy Blackburn. Certified Fitness Instructor. *Dance off the inches: Country line dance*. 2008. [DVD]

Desiree Bartlett. Certified Fitness Instructor. *Dance and be fit: Latin groove*. 2008. [DVD]

THIS PAGE INTENTIONALLY LEFT BLANK

ORIENTEERING

INTRODUCTION

By participating as an individual or as a member of an orienteering team, the cadets are given the opportunity to be active in a sport that will contribute to their living a healthy, physically active lifestyle.

EQUIPMENT

- Prepared point-to-point orienteering course,
- Prepared point-to-point orienteering course map,
- Scorecards / control cards,
- Punches
- Description sheets,
- Stopwatches,
- Whistles,
- String / twine,
- Hand-held radios,
- Table,
- Chairs, and
- Marker tape.

ACTIVITY GUIDELINES

Orienteering should be well supervised and conducted by an experienced instructor.

BACKGROUND KNOWLEDGE

Point-to-Point Orienteering

Also known as cross-country orienteering, point-to-point orienteering requires cadets to determine their own routes from one known control to the next, in a specific order. The winner is the cadet(s) who completes the course in the shortest elapsed time.

Point-to-point orienteering is the most popular of orienteering events. One reason is that it is a battle of physical stamina and quickness of mind against other participants.

Scoring Equipment

Control Markers. Found at control points on an orienteering course, control markers consist of three squares joined together to form a hollow triangular shape. Control markers are divided diagonally bottom left to top right into two triangles. The top left-hand triangle is white and the bottom right-hand triangle is an orange-red colour.

Controls may be marked with a control identifier. This identifier may be some type of number / letter or combination of both. The identifier will be written in the top left triangle of the marker and will inform the orienteer that the correct control has been located.

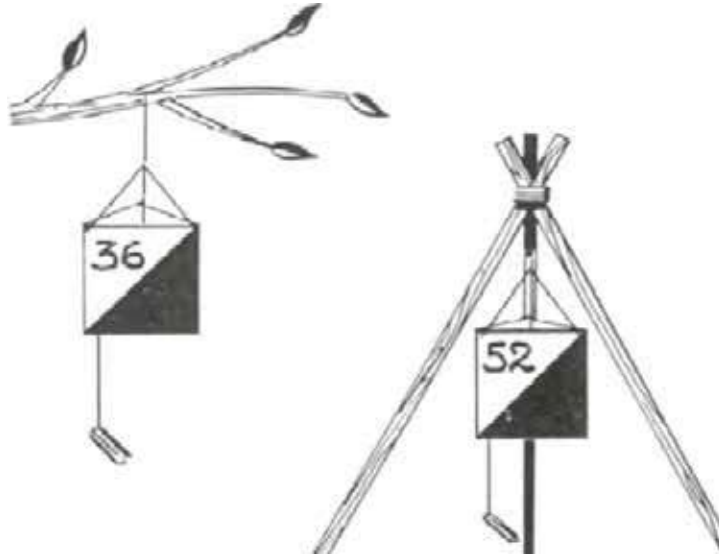

Figure F-1 Control Markers



Orienteering control markers can be created by using cardboard or plastic jugs.

Punches (Clippers). Attached to the control markers, the punch will often hang from the control marker. Each punch on an orienteering course is different and aids an orienteering competition by having the competitors use the punch on their scorecards in a specified order. Each punch has a different series of numbers or letters.

Description Sheets. The description sheets contain all the information on the competitor and their race, as well as International Orienteering Federation (IOF) symbols or written descriptions of the control points.

Scorecards. Also known as the control card, it is what the competitor uses to collect the stamps of the control markers on the course. It is handed in at the end of the race.



Orienteering ^s Control Point Card color 		CLASS <u>MI</u> COURSE <u>W</u> NO. <u>16</u> NAME <u>JOHN DOE</u> CLUB <u>NONESUCH</u> compass day time ck punch ck place ALL COMPETITORS MUST REPORT TO THE FINISH	FINISH <u>1:46:45</u> START <u>:18:00</u> TIME <u>1:28:45</u>	DETACH 	FOLD TIME <u>1:28:45</u> color COURSE <u>W</u> NAME <u>JOHN DOE</u> CLUB <u>NONESUCH</u>
11 12 13 14 15 16 17 18 19 20 1 2 3 4 5 6 7 8 9 10	PLACE DAY CLASS <u>MI</u> NAME <u>JOHN DOE</u> CLUB <u>NONESUCH</u>				

Figure F-2 Scorecard

Orienteering Maps

The map scale is found at the bottom of the map title. The most common scales for topographical maps in Canada are 1:25 000 and 1:50 000. Common orienteering map scales are 1:5 000, 1:10 000, 1:15 000 and 1:20 000. This means that on a 1:5 000 scale map one unit on the map represents 5 000 units on real terrain. The smaller the map scale, the smaller the area is, and the more detail there is available to the competitor.

Orienteering Techniques

Folding and Holding the Map. Folding the map involves the orienteerer gently folding the map so the route is showing, running along the direction of travel, with everything else folded out of the way. It helps the orienteerer see only the information pertaining to them at the time.

Orienting the Map by Inspection. A map is oriented when north on the map is aligned with north on the terrain. The orienteerer should pick two or three objects around them and then locate them on the map. The real landmarks and the ones on the map should line up.

Thumbing Position. The orienteerers should be holding the map so their thumb is placed on the map to mark their position, adjusting their thumb position to their location each time they stop to reference the map. It saves time, helping to quickly determine where the orienteerer is, no matter how many times they have to stop and look at their map. Two steps involved in this process are ensuring the map is held properly and holding the map so it is oriented north.

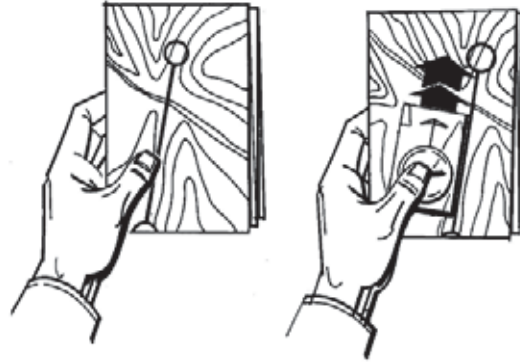

Figure F-3 Thumbing Position

Determining Distance. Orienteers should not rely on features for judging distance; they may no longer exist though they still appear on the map. The best way is step counting or pacing. This is determined by knowing how many steps or paces an individual takes in 100 m. To save time, an orienteerer should know this before beginning.

Checking Off Features. The orienteerer identifies linear features that appear before the control that will alert the orienteerer the control is nearby. As an orienteerer navigates toward the control, they have a mental checklist of the features as they come upon them.

Handrails. A handrail is a prominent linear feature that runs parallel to the direction the participant is supposed to go and leads to the control. A path between two points would be a handrail.

Catching or Collecting Features. Catching or collecting features is a technique for route evaluation that helps the orienteerer make a mental checklist of all the features they must collect or catch before they can get to their control. It is a large distinct feature situated across the line of travel on the route to, or beyond, the control. It must be a feature that is easy to recognize in the terrain, such as a large pond or power line. If it is situated in front of the control, it acts as an alert to the control. When situated beyond the control, it alerts the orienteerer that they have travelled past the point of the control.

Attack Points. Some points are located on small features that are not easily found. For this, the orienteerer might locate a larger feature as close to the control as possible. The orienteerer will look for this feature, called the attack point, run toward this point and then look for the control close by.

Attacking From Above. A control located on the side of a slope is easier for the orienteerer to find when they are coming down the slope. The orienteerer gets a better view of the terrain by looking down on it and is therefore able to find the best route to the control.

Height Assessment Versus Detouring Around. When a hill is between controls, a decision must be made by the orienteerer whether to go over or around. It must be decided if it is easier for the individual to climb the slope and possibly expend more energy, or to go around, which may be a longer route but easier to run due to level ground. The elevation of the slope may be a deciding factor.

Long Easy Route Versus Short Tough Route. A competitor must take into consideration the distance to travel both routes, and how quickly they will be able to travel over the terrain. This will be dependent on the vegetation that will be encountered.

Route Evaluation Techniques Using The CART Acronym

A systematic approach to map reading, represented by an acronym meaning:

- **Control.** What control is the orienteerer trying to find?
- **Attack point.** What is an attack point that is easy to identify? It should be close to and before the marker, distinct, prominent and easy to reach.
- **Route choice.** What is the best route to the attack point? This will depend on the nature of the terrain, the distance to be covered and the skills and abilities of the orienteerer.
- **Technique.** What is the best technique to use on each leg of the competition? This will depend on the terrain, distance and the individual orienteerer, but must be decided before starting the leg.



This may seem overwhelming for the novice orienteerer, but point out to the cadets that they would naturally use some of these techniques without realizing it.

Start and Finish Routine

At the start of the event, the cadets will move to the starting line and wait for a blast from the instructor's whistle. At this point, a departure time must be written down on the recording sheet (as illustrated in Figure B6-5).

Usually at the beginning of the event there will be an area called the starting grid. This gives the participants a three-minute preparation period prior to starting the event.

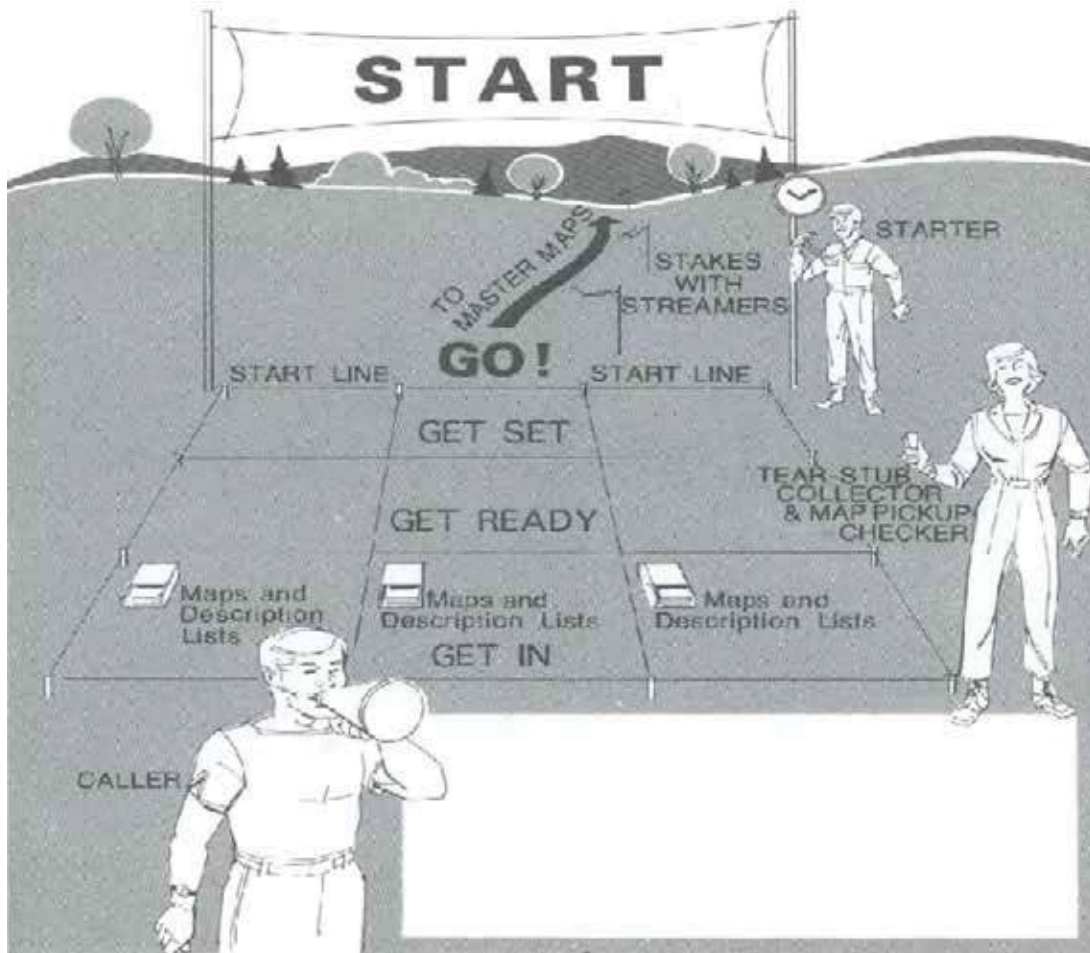

Figure F-4 Starting Grid

Three minutes before the cadet is to start, they are called to the “Get In” row of the starting grid. A minute later, upon hearing a whistle, the cadets move forward to the “Get Ready” row, where they review a copy of the description list and the map (if it is not a pre-marked map). One minute before the start, the cadets move to the “Get Set” row, where pre-marked maps are distributed, but they are not allowed to be looked at until they hear the “Go” whistle.

On the zero-minute, there will be a “Go” whistle, signaling the cadets to begin. It is at this point that the departure time is recorded on the recorder’s sheet.

RECORDING SHEET								
EVENT _____			PLACE _____			DATE _____		
NAME	No.	Team	Class	Start Time	Finish Time	Time Used	Controls Missed	Position

Figure F-5 Recording Sheet



Cadets are to be given pre-marked maps at this level.

Course Layout

A point-to-point type of orienteering (also known as cross-country or free orienteering) event will be conducted to allow the cadets to assist with orienteering. This type of orienteering is considered the ultimate challenge for orienteers. The course and markers are placed in a circular configuration where every competitor must visit the same control in the same order in the shortest amount of time. This challenges the competitor to choose the best possible route and maintain stamina.

The layout of the course is based on the competitor level of experience and usually consists of 8–12 controls situated in varying degrees of difficulty and distance.

RULES AND REGULATIONS

Orienteering meets expect competitors to follow basic rules and regulations that also deal with ethics and safety when participating in a point-to-point orienteering activity.

Technical Rules

- Participants shall not damage, remove or hide any controls during an event.
- Participants shall only use the map provided by the organizer plus a compass during an event.
- Participants shall visit the controls in the specified order in a point-to-point orienteering event.
- Participants must not enter / cross areas marked on the map as uncrossable or out of bounds.
- Participants shall not damage property such as fences or equipment.
- Participants shall not enter / cross gardens, newly-planted fields or those with growing crops.

Safety Rules

- Cadets should wear clothing that covers the full body.
- Cadets must carry a whistle during the event.

- Cadets should be familiar with the international distress signal (three blasts on a whistle).
- Cadets must report to the finish official and hand in their map and control card whether or not they complete the course.
- Cadets must aid injured persons they encounter during the event.
- Cadets must observe traffic rules when crossing roads or railways.
- Organizers shall provide safety bearing information.

Ethical Rules

- Cadets should not follow others.
- Cadets should not discuss the course with others while on the course.
- Cadets who ask for assistance should be shown their location on the map and then report it to an official at the finish.
- Cadets who have finished their course should not divulge information about the course, map or terrain to others who have not started.
- Cadets shall respect the land and environment.

SCORING AND TIMING

The finish line is where all scoring and timings will take place. It is important that the finish area allows officials to properly complete their tasks. Officials will have to record, calculate times and verify each orienteerer visited each control on the course.

When competitors finish, officials are responsible for four main tasks:

1. collecting control cards in order of finish,
2. calculating and recording finish times,
3. verifying control card punch patterns, and
4. displaying results.

SUGGESTED RESOURCES

ISBN 0-02-029265-1 Kjellstrom, B. (1994). *Be Expert With Map & Compass: The Complete Orienteering Handbook*. New York: Hungry Minds, Inc.

Stott, W. (1987). *Armchair Orienteering II: A Practical Guide to Route Planning*. Winnipeg: Manitoba Orienteering Association.

ROLLERBLADING

INTRODUCTION

Rollerblading increases the body's flexibility and endurance with very low impact. It boosts the cardiovascular system while also improving balance and agility.

EQUIPMENT

- Rollerblades,
- Knee pads, elbow pads, wrist guards, and
- Helmet.

ACTIVITY GUIDELINES

Rollerblading shall be conducted on smooth, paved surfaces such as established paths.

ROLLERBLADING TECHNIQUES

Start on Carpet or Grass. Have new rollerbladers start on carpet or grass because the wheels will not roll. This allows them to get used to the increased height and its affect on their centre of balance.

Falling and Getting Up. Have new rollerbladers fall forward, sliding on their knee pads and wrist guards. If they feel like falling backwards, have them grab their knees. This will pull them forward, so they will either stay upright, or fall forward. Make sure the wrist guards impact at a sliding angle—not straight down, as this may cause a jarring impact that can cause injury.

Practice Moving. Have new rollerbladers get a feel for how to move. Have them take a few steps. Also have them move one foot forward while gradually increasing pressure on that foot until there is almost no pressure on the other. Have them do the same with the other foot until they are able to "glide" back and forth a few times.

Move to a Hard Surface. Concrete is ideal because the wheels will find friction easily while allowing movement more freely than carpet. Asphalt is not recommended for beginners because its smoother surface will force the wheels to roll more easily.

Experiment. Experiment. Practice turning, balancing on one skate, and walking.

Braking. Just like driving riding a bike, or even running, have the cadets anticipate where they want to stop. To brake, move one foot forward and bend the knee slightly and apply pressure on the heel.

SUGGESTED RESOURCES

Nil.

THIS PAGE INTENTIONALLY LEFT BLANK

RUNNING

INTRODUCTION

Running is one of the most common activities to develop cardiovascular fitness. Running may be done at a variety of speeds, which enables the cadets to vary the intensity of the training session.

EQUIPMENT

Running shoes.

ACTIVITY GUIDELINES

Running shall be conducted in a dry, safe environment or indoors on an established running track.

RUNNING TECHNIQUES

There are six main techniques for running, used to cover the distance at maximum speed with minimum effort; they are:

Poise of the Head and Balance of the Body. The poise of the head controls the balance of the body. The head should be held in alignment with the trunk, the neck muscles relaxed, and eyes looking ahead. The chest and hips should be kept square to the front. There should be no bending at the hips, either forward or backward. A conscious effort to maintain alignment may be necessary.

Leg Action. The legs are the driving forces behind the body, as well as the supporting power. When running, the toes should be pointed straight ahead, the knees should be lifted forward, and hip rolling should be avoided. The lower leg should be kept completely relaxed as it swings forward; the foot just clearing the ground. Do not use a bouncing or bounding stride in which the body weight is shifted upwards unnecessarily.

Arm Action. While running, the arms act as speed and balance controllers. The most efficient direction for the swing of the arms is forward and inwards, partly following the direction of the body and partly in towards the centre of gravity of the body. Shoulder movement should be reduced to a minimum. Shoulder rolling and shoulder shrugging should be avoided. Avoid contracting the muscles of the neck. Each person will find the most comfortable height for carrying the hands.

Limb Coordination and Rhythm. These come automatically to maintain body balance and ensure smooth movement. A change or break of rhythm leads to less efficiency and greater fatigue.

Relaxation. A certain degree of relaxation comes naturally, but increasing relaxation of the upper body during running may take practice and concentration. When increases in relaxation occur during running, more efficient motion will take place, resulting in distance being covered in less time.

Breathing. Breathing in and out should be done through both the nose and the mouth. Inhale mostly through the nose and exhale mostly through the mouth. Breathing should follow an automatic rhythmical rate set by limb movement.

Duration of a Training Session

All running activities should begin with a warm-up. The main part of a running training session may be a straight distance run, around a track, on a road, or cross-country. A minimum of 15 and preferably 20 minutes of sustained running is required to increase cardiovascular fitness. Running for time or distance will aid in increasing fitness levels. The cool-down should include slowing the pace of the run and flexibility exercises. It is essential that the heart rate is brought below 100 beats per minute before the cool-down is considered complete.

Alternating Terrain

Running on alternating terrain may be conducted on a course laid out along roads, across fields, over hills, through woods, or on any irregular ground. Running on alternating terrain provides a break in routine. Many runners prefer to follow cross-country trails rather than run on tracks or roads.

SUGGESTED RESOURCES

ISBN 0-684-85455-4 Bingham, John. (1999). *The courage to start: A guide to running for your life*. New York, NY: Fireside.

SKIPPING ROPE

INTRODUCTION

Skipping will help improve cardio-respiratory (heart and lungs) fitness, flexibility and co-ordination. As a high-impact exercise, skipping is great for building bones and a good exercise to lose weight and define muscle mass.

EQUIPMENT

- Running shoes, and
- Skipping rope.

ACTIVITY GUIDELINES

To help prevent injury, running shoes shall be worn during skipping rope exercises.

Skipping to music, combining different foot combinations and also adding circuit exercises helps maintain interest while skipping.

SKIPPING ROPE TECHNIQUES

Running on the Spot. Run on the spot with the rope passing underneath between each step.

Side Rope Swings. Push the skipping rope to the side by moving both hands to one side. On the next skip, bring the rope back to the middle so it goes around the body. This movement is great for transitioning from one combination to another and can be used to relieve arm tension.

High knees. After each skip, bring the knee up to the chest. Attempt to bring each knee up as high as possible to activate the hip flexors and extensors and the abdominal musculature.

Heel to Toe. Alternate landing on the toes of your feet and on the heels of your feet. Be careful when landing on the heel—it should be a soft landing.

Split Jumps. On each skip, alternate one foot forward and one foot back. Land on the toes of each foot.

Criss-Cross. The feet cross and uncross each jump. Alternate between crossing the left foot with the right foot and the right foot with the left foot. Use different combinations of each cross-over. This improves your coordination and focus.



Figure I-1 Criss-Cross Pattern

Double Jumps. Jump high enough and swing the rope fast enough so the rope goes around twice for each jump.

One Foot Jumps. Skip on one foot instead of two. This version works the calf muscles. The number of jumps per foot (double jumps) or the way you land on each foot (heel to toe) can be varied to create and maintain interest.

One + Combo. This is a combination of the one foot jumps and the side rope swing. Do one one-foot-jump on each foot, then do a side swing. Do two one-foot-jumps on each foot then a side swing. Next are three one-foot-jumps and a side swing. Continue progressively increasing the number of jumps.

Two-By-Two Combo. Jump twice on the right foot and twice on the left foot; continue alternating. This combo can be increased to a three-by-three combo or a five-by-five combo.



Figure I-2 Split Jumps Pattern

SUGGESTED RESOURCES

Heart and Stroke Foundation of Canada. (2011). *Skipping skills posters*. Retrieved November 10, 2011 from http://www.jumpropeforheart.ca/Content/Files/SkillsPosters_2011_E.pdf

SHOWSHOEING

INTRODUCTION

Snowshoeing is an aerobic activity that involves walking through the snow and is an easy skill to learn. It tones your entire body while providing an excellent cardiovascular workout; it strengthens leg and heart muscles and improves delivery of oxygen to muscles. People can immediately walk on snowshoes even if they have never worn them before. Snowshoeing helps improve the cardiovascular and muscular strength components of fitness.

EQUIPMENT

Snowshoes. The chart below is a rough guide to follow when in a standard condition of wet powder snow.

Snowshoe Size	Carrying Capacity
20 cm by 56 cm (8 inch by 22 inch)	68 kg (150 lbs)
20 cm by 63 cm (8 inch by 25 inch)	90 kg (200 lbs)
22 cm by 43 cm (9 inch by 34 inch)	113 kg (250 lbs)
24 cm by 86 cm (9.5 inch by 36 inch)	136 kg (300 lbs)

The smaller the snowshoe, the better it will be for climbing over blow downs (fallen trees and bushes) and through brush. The larger the snowshoe, the better flotation on top of snow.

Bindings. The binding attaches the foot to the snowshoe securely, preventing the heel from sliding from side to side, even when travelling across a slope. Bindings most often fit a wide range of boot sizes. In any category of snowshoe, the binding should be made of hardy, flexible rubberized nylon straps, with buckles that do not loosen or freeze and are easily manipulated even when wearing mittens. The bindings must not be fastened too tightly where circulation may be cut off, as the chances of frostbite will increase.

Poles. Telescoping trekking poles are the most versatile choice for snowshoeing. These poles provide better balance and reduce the amount of stress on the knees, shoulders and back. They absorb some of the impact the body would otherwise absorb. The poles, rather than the body, absorb shock, reduce arm and leg fatigue and improve endurance. While snowshoeing, they help a person keep balance while climbing inclines or when backing out of an area in deep snow. Although trekking poles are generally not required when snowshoeing, they are a helpful accessory.

ACTIVITY GUIDELINES

Snowshoeing shall be limited to new fallen snow, powder snow, and wind-packed snow. Refer to the Skiing section for more information on types of snow. The same types of snow as skiing should be avoided when snowshoeing.

SNOWSHOEING TECHNIQUES

Snowshoeing is a very easy skill to learn. People can immediately walk on snowshoes even if they have never worn them before. However, there are techniques that will greatly improve these abilities while snowshoeing over snow-covered terrain.

Striding

To conserve energy when snowshoeing on soft snow, lift the snowshoe to clear the snow and thrust forward to complete each pace. The rest step allows for momentary pauses between steps. With practice, one can adjust the length of the pause to the state of fatigue. As one steps forward, thrust the front snowshoe out and let it plop down, or stamp it firmly into place. Straighten and lock the rear knee joint so the tendons and cartilage are holding weight and pause and relax the thigh muscles, using the poles to maintain balance. Bring the rear leg ahead, thrust the snowshoe out, place it, lock what is now the rear leg, relax momentarily and repeat. The effect is to rest the legs during the time they are actually working hard. A couple of seconds of work with a couple of seconds of rest make it possible to keep going steadily without long stops.

Executing Kick Turns

Kick turns are performed when a change in direction is required. It is commonly used in an enclosed area along the trail. The steps in performing a kick turn are:

1. Lift one leg and swing it back, and then kick it forward and upward.
2. At the top of the kick, just as the tail of the snowshoe clears the snow, turn the foot 180 degrees.
3. Lower and plant the foot in the snow, with the front of the foot facing to the rear.
4. Shift the body weight to the foot facing 180 degrees to the rear and then lift the other foot.
5. Bring the foot over the trailing edge of the planted snowshoe and face the new direction.

Crossing Obstacles

Obstacles such as fallen trees, logs, tree stumps, ditches and small streams can be stepped over. Care must be taken not to place too much strain on the snowshoe ends by bridging a gap, since the frame may break. In shallow snow, there is a danger of catching and tearing the webbing on tree stumps or snags that are only slightly covered. Never bridge two obstacles together with the snowshoes. When jumping over obstacles do not let the tails of the snowshoes fall downward. If the tail of the snowshoe is vertical upon landing, it will strike the snow first and may result in a fall. When possible, find an alternate route around the obstacle.

Ascending Hills

The method chosen to walk uphill will depend on the angle of the incline and the condition of the snow. The following techniques can be used when navigating uphill.

Step kick. When going straight up a hill, this is the most efficient method on firm or hard packed snow where traction is not a concern. Kick the toe of the snowshoe in the snow ensuring that it is firmly planted before shifting weight to the snowshoe.

Edging. Used when walking up a steep slope. Performed by kicking the snowshoe sideways into the slope, or moving the boot heel as far toward the uphill side of the slope as possible. Stamp the snowshoe down, forcing the outside edge of the snowshoe into the slope. When edging, the body will be perpendicular to the slope.

Switchbacking. Used to travel a slope that is fairly steep and is covered in deep powder snow. Ascend the hill by walking across the slope at an angle that is comfortable and not steep enough to allow the snowshoes to slip. To turn back (switchback) to the right, firmly stamp the left snowshoe in the snow and make sure it will hold. Shift the weight to the left foot, face the slope, and then swing the right snowshoe around to point it in the direction of the next switchback and firmly stamp it into the snow. Ensure that the tail of the right snowshoe is not placed on the left snowshoe. Stamp the right web into the snow and gently shift the body weight to step on it. To make a left turn, reverse the procedure.

Descending Hills

The method that is chosen to walk downhill will depend on the angle of the incline and the condition of the snow. The same techniques for ascending hills are used to descend. When descending a hill a person should follow the following guidelines:

- Do not lean forward by bending at the waist. This is a normal tendency for beginners and will increase the chance of falling forward.
- Avoid leaning back on the snowshoes, as if digging in the heels. This will increase the chance of the snowshoes sliding out from under the snowshoer.
- To assume a safe posture, stand straight up, balance the body straight over the foot, slightly bend the knees to compensate for changes, and then relax.

Breaking Snow

In loose snow, the trailbreaker may have several extra pounds of snow on the snowshoes. The snow falls on top of the webbing when walking and sinking in deep snow. This extra weight will exhaust the trailbreaker at a faster rate than the followers. When the trailbreaker feels they can no longer move forward at a progressive pace, they should step to the side and drop to the rear as the rest of the party moves past.

SUGGESTED RESOURCES

Edwards, S. & McKenzie, M. (1995). *Outdoor pursuits series: Snowshoeing*. ISBN 0-87322-767-0. Windsor, ON: Human Kinetics Inc.

Savignano, P. (2001). *Basic essentials: Snowshoeing*. ISBN 0-7627-0629-5. Guilford, CT: The Globe Pequot Press.

THIS PAGE INTENTIONALLY LEFT BLANK

SWIMMING

INTRODUCTION

Swimming is a fun activity that can include doing laps, playing games and aqua aerobics.

EQUIPMENT

The equipment required will depend on the selected swimming activity.

ACTIVITY GUIDELINES

This activity shall be conducted IAW A-CR-CCP-030/PT-001, *Water Safety Orders*, Chapter 6.

SWIMMING GAMES / ACTIVITIES

Whirlpool. Have the cadets stand in a circle holding hands, in the shallow end of the pool. Have the group start walking in a clockwise direction, moving faster and faster creating a whirlpool. Once the group has gained momentum, count to three and have the cadets let go. The whirlpool will spin the cadets outwards.

Sharks and Minnows. This is a game of tag, where one cadet is designated the “shark” and the rest “minnows”. The minnows must constantly move in the water trying to avoid being tagged by the shark.

Aqua Aerobics. Aqua aerobics is an excellent activity for those who have suffered injury or are beginning cardiovascular fitness training as it causes little stress on the joints. If it is selected, it shall be conducted by a certified instructor or using a video that is conducted by a certified instructor.

SUGGESTED RESOURCES

Karen Westfall, Aqua Fitness Expert. *Aqua Combo Splash*. N.D. [DVD]

Katz, Jane. (2003). *Your water workout: No-impact aerobic and strength training from yoga, Pilates, tai chi and more*. ISBN 978-0767914826. USA: Broadway Books.

Kidspot. (2011). *Pool water*. Retrieved November 28, 2011, from www.kidspot.com.au/kids-activities-and-games/Pool-Water+8.htm

THIS PAGE INTENTIONALLY LEFT BLANK

MUSCULAR STRENGTH EXERCISES USING THE BODY, BALANCE BALLS, RESISTANCE BANDS, AND WEIGHTED BALLS AND BARS

INTRODUCTION

Well-structured resistance training can provide youth many health benefits, such as preventing injuries, increasing strength / endurance / power, and assisting to build strong, healthy bones.

EQUIPMENT

- One balance ball per cadet, and/or
- Resistance bands / weighted balls / weighted bars (various resistance levels / weights), and
- One mat per cadet.

ACTIVITY GUIDELINES

Activities using equipment shall be conducted by a F&SI trained in its use or a certified trainer.

Choose a training area that has adequate space (eg, balance balls may roll around very easily).

Conduct each new exercise using the following method (If the exercises are used as part of a circuit, introduce them all before the cadets start the circuit):

1. Demonstrate the complete exercise.
2. Demonstrate the starting position and have the cadets adopt the starting position.
3. Demonstrate the subsequent movements and have the cadets complete each movement.
4. Demonstrate the complete exercise and have the cadets complete the entire exercise.

Safety

To avoid injury and maximize the effectiveness of the exercise, have the cadets complete the movements in a slow, deliberate, and controlled manner. Have them use lightweight equipment.

Ensure the balance balls are sized to the cadets. Cadets should be able to sit on the ball with their feet touching the ground and legs at a 90-degree angle or slightly more.

Instruct the cadets to maintain a good grip on the equipment and to not let go of resistance bands during the exercises as they might snap back and cause injury.

EXAMPLES OF RESISTANCE EXERCISES USING THE BODY

Push Up. Lay face down and place the hands under or slightly wider than the shoulders with fingers stretched out. Straighten the legs with feet slightly apart and tuck the toes under the shins. Push up with the arms until they are straight, keeping the legs and back aligned. Lower the body using the arms until the elbows bend at a 90-degree angle and the upper arms are parallel to the floor.



Figure L-1 Push Up

Curl Up. Lay on the floor with the back and head down. Place the feet flat and legs slightly apart. Feet should be extended as far as possible from the buttocks while still allowing feet to remain flat on the floor. Rest the palms on the mat with the arms straight, parallel to the trunk, and fingers stretched out. Curl up slowly, keeping the heels in contact with the floor.



Figure L-2 Curl Up

Lunge. Stand with one leg forward and one backward. Slowly bend the knees, lowering into a lunge while keeping the front knee and back knee at 90-degree angles. Keeping the weight in the heels, push back up to starting position.



Figure L-3 Lunge

Squat. Stand with feet shoulder-width apart. Push the hips back while bending at the knees, as if sitting into a low chair. Push through the heels and extend the knees to return to the start position.



Figure L-4 Squat

Bridge. Lay on the floor with hands by the sides, knees bent and feet flat on the floor. Keeping the head and shoulders on the floor, raise the hips up to create a straight line from the knees to the shoulders. Hold for 20–30 seconds.



Figure L-5 Bridge

SUGGESTED RESOURCES

ISBN 978-0-7360-6675-4 Corbin, C., & Lindsey, R. (2007). *Fitness for life: Updated fifth edition*. Windsor, ON: Human Kinetics.

EXAMPLES OF BALANCE BALL EXERCISES

Ball Crunch. Lie on top of the ball with the lower back resting on the ball, fingers behind the ears. Pull the stomach in and curl the head and torso up towards the knees. Lower to the start position.



Figure L-6 Ball Crunch

Ball Plank. Place the forearms on the ball and raise the chest, so the elbows are under the shoulders. Extend the legs behind on the floor. The body should form a straight line from ankles to head. Pull the shoulder blades back and down, and brace the abs. Hold this position for 30 to 60 seconds.



Figure L-7 Ball Plank

Ball Push Up. Begin with the hands set slightly wider than and in line with your shoulders, and shins resting on the ball, forming a straight line with the body from shoulder to ankles. Lower the upper body towards the floor by bending the elbows. Push the upper body back to the original position by straightening the elbows. An alternate for this exercise is to complete the push up with the hands on the ball, placed under the shoulders and pushing up.



Figure L-8 Ball Push-Up

Ball Jackknife. Begin with the hands set slightly wider than and in line with your shoulders, and shins resting on the ball, forming a straight line with the body from shoulder to ankles. Roll the ball towards the chest by raising the hips and slightly rounding the back while pulling the ball forward with the feet. Pause, and then return the ball to the starting position by rolling it backwards.



Figure L-9 Ball Jackknife

Ball Hand-to-Feet Pass. Begin lying on the back with the ball held up with the hands above the chest. Raise the legs towards the ball with knees slightly bent and pass the ball from the hands to the feet. Move the ball towards the floor by lowering the legs. Raise the ball up towards the hands and pass the ball from the hands to the feet.

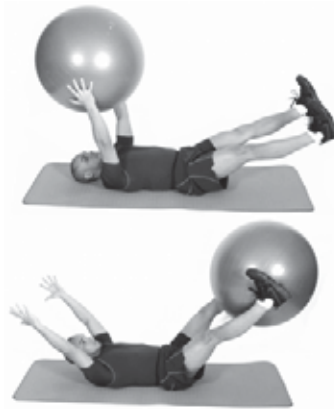

Figure L-10 Ball-to-Feet Pass

SUGGESTED RESOURCES

Mari Winsor, Certified Pilates instructor. *Winsor Pilates ball workout*. 2005. [DVD]

Allie DelRio Pointer, Firm Master Instructor. *The Firm: Core stability ball*. 2006. [DVD]

ISBN 9781856486637 Flett, M. (2003). *Swiss ball: For strength, tone, and posture*. New York, NY: Sterling Publishing Limited.

EXAMPLES OF RESISTANCE BAND EXERCISES

Bicep Curl. Stand on the band with knees bent, holding the handles (or the ends) with the palms facing forward. While keeping the abs in, bend the arms bringing the palms toward the shoulders. Widen the stance on the band to add tension to the band. Return to start and repeat.



Figure L-11 Bicep Curl

Triceps Extension. Hold the band in both hands at shoulder level with the arms bent in front of the chest. Keeping the left hand stationary, straighten the right arm out to the side. Return to start. Repeat for the left arm.



Figure L-12 Triceps Extension

Rear Delt Fly. Hold the band in both hands, a few inches apart, with arms straight out in front at shoulder level. Squeeze the shoulder blades together and pull the band so that the arms are out to the sides like an airplane. Return to the start and repeat, keeping tension on the band the entire time.



Figure L-13 Rear Delt Fly

Overhead Press. Place both feet on the band and grasp handles / ends, bring the hands up just over shoulders with elbows bent and palms facing towards the ears. Press arms up over the head and then lower.

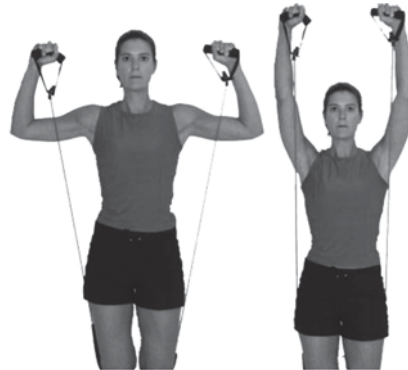

Figure L-14 Overhead Press

Squats. Stand on the band with feet shoulder-width apart, keep tension on the band by holding the ends of the band in each hand with the arms bent halfway up. Lower into a squat (as if sitting in a chair) keeping the knees behind toes. Pull on the band to add tension. Return to the start and repeat.



Figure L-15 Squats

SUGGESTED RESOURCES

Paul Katami, Certified Fitness Instructor. *Paul Katami's A.S.A.P. Band Camp*. 2009. [DVD]

Alison Davis-McLain, Certified Group Fitness Instructor. *The Firm: Pilates Band*. 2006. [DVD]

ISBN 9781856487245 James, M. (2004). *Resistance band workout: A simple way to tone and strengthen your muscles*. New York, NY: PRC Publishing Limited.

EXAMPLES OF RESISTANCE EXERCISES USING WEIGHTED BALLS

Triceps Extension. Stand with feet spread shoulder width apart (or sit on a chair / balance ball). Hold the weighted ball over the head with the elbows tucked in near the ears. Bend the elbows backward to lower the weighted ball behind the head. Raise the ball to the original position.



Figure L-16 Triceps Extension

Figure of Eight. Hold the weighted ball with the arms extended over the right shoulder and the knees bent. In one continuous motion bring the weighted ball down in front as if chopping wood, finishing when the ball is toward the left foot. Raise the weighted ball straight up over the left shoulder. Bring the weighted ball down in front using the same motion as the first part of the movement, finishing when the ball is toward the right foot. Repeat in a continuous figure of eight motion.



Figure L-17 Figure of Eight

Weighted Ball Obliques. Lay on the back with the knees bent up towards the chest. Place a weighted ball between the knees and hold in place with the knees. Slowly rotate the legs to one side. Return the legs to the centre. Repeat the movement for the other side.



Figure L-18 Weighted Ball Obliques

Reverse Curls. Lay on the back with the knees bent and feet parallel to the floor. Place a weighted ball between the knees and hold in place with the knees. Slowly raise the ball towards the chest. Slowly return the feet to the original position.



Figure L-19 Weighted Ball Twist

Weighted Ball Twist. Sit on the floor with knees bent and feet placed flat on the floor. Hold a weighted ball straight in front with the arms in line with the shoulders. Keeping the back straight, lean back slightly. Slowly and in a controlled form, pull the abdominal muscles in and rotate the torso to the side. Return to the centre. Repeat the movement for the other side.



Figure L-20 Weighted Ball Twist

SUGGESTED RESOURCES

Patrick Goudeau, National Academy of Sport Medicine (NASM) certified trainer. Patrick Goudeau's Play Ball. 2008. [DVD]

ISBN 9781585189007 Mediate, P. & Faigenbaum, A. (2004). Medicine ball for all training handbook. Monterey, CA : Healthy Learning.

EXAMPLES OF RESISTANCE EXERCISES USING WEIGHTED BARS

Bicep Curl. Begin by grasping the weighted bar with an underhand grip about shoulder width apart. Begin with the bar resting at the thighs with the elbows slightly in front of the body. Bend the elbows to bring the bar up towards the shoulders without letting the elbows move behind the body. Return to the starting position.



Figure L-21 Bicep Curl

Shoulder Hold Squat. With feet about hip distance apart, bring the weighted up and over the head to and rest it on the back of the shoulders. Push the hips back while bending at the knees, as if sitting into a low chair. Push through the heels and extend the knees to return to the start position. Be sure not to pull on the bar during the squat, but rest the hands lightly on the underside of the bar during the movement.



Figure L-22 Shoulder Hold Squat

Bent Over Row (Overhand). Begin with the feet hip-width apart (or wider), grasping the weighted bar with an overhand grip. Tilt at the hips and let the bar hang at the knees. Hands should be just outside the knees to begin. Bend the elbows and pull back to bring the bar in towards the crease of the hip. Elbows should be tucked in close to the sides. Extend the elbows to return to the starting position.



Figure L-23 Bent Over Row (Overhand)

Two Arm Chest Press. Lay on the floor with knees bent so both feet are on the floor. Grasp the weighted bar in an overhand grip with hands slightly wider than shoulder width. Ensure the weighted bar begins directly over the chest with arms straight. Bend the elbows out to the sides to bring the bar towards the chest. Extend elbows to return to starting position.



Figure L-24 Two Arm Chest Press

Reverse Abdominal Curl. Lay on the floor with knees bent so both feet are on the floor. Place the bar underneath the knees and lift feet off the floor. Curl the bottom away from the floor to execute the reverse curl. Return to the starting position.



Figure L-25 Reverse Abdominal Curl

SUGGESTED RESOURCES

Rob Glick, Bachelor of Science in Exercise Science. Body bar: Deep definition. 2003. [DVD]

ISBN 978-1-4027-3190-7 Cook, Greg & d'Almeida-Cook, F. (2006). Body bar: 133 moves for full body fitness. New York, NY: Sterling Publishing Co.

THIS PAGE INTENTIONALLY LEFT BLANK

PILATES

INTRODUCTION

Pilates was created by Joseph H. Pilates in the 1920s. This type of exercise focuses on strengthening the core muscles. This muscle-strengthening activity is also helpful for managing weight as it strengthens and lengthens core muscles without adding bulk. Pilates helps improve the muscular strength and muscular flexibility components of fitness.

EQUIPMENT

One mat per cadet.

ACTIVITY GUIDELINES

Pilates shall be conducted by a certified instructor or using a video that is conducted by a certified instructor.

SUGGESTED RESOURCES

Ellen Barret, Certified Pilates and fitness instructor. *Crunch: Pick your spot Pilates*. 2002. [DVD]

Kristin McGee, Pilates master instructor. *Pilates for beginners with Kristin McGee*. 2009. [DVD]

THIS PAGE INTENTIONALLY LEFT BLANK

STRETCHING

INTRODUCTION

Stretching involves performing exercises to lengthen the muscles and improve flexibility. There are three types of stretching:

- **Static Stretching.** Stretching without movement. An example would be a shoulder stretch done by pulling the arm across the body and holding the arm still for a minimum of 10 seconds.
- **Proprioceptive Neuromuscular Facilitation.** Contracting the muscles before statically stretching them, eg. using a towel to help with a calf stretch and contracting the calf by pushing the toes against the towel; followed by pulling on the towel to stretch the calf muscle.
- **Ballistic Stretching.** Using bobbing or bouncing causing the muscles to stretch. This type of stretching is not recommended for beginners as it can lead to injury if done improperly.

EQUIPMENT

One mat per cadet.

ACTIVITY GUIDELINES

Have the cadets wear loose clothing that allows free, unrestricted movement. Have them participate in a general warm-up consisting of light cardiovascular activities that will help raise the heart rate and warm the muscles prior to doing any stretches.

STRETCHES

Sample stretches are located at Attachment B of EO MX04.01 (Participate in 60 minutes of MVPA and Track Participation in Physical Activities). The stretches shall be conducted as static stretches. At no time shall any be conducted as ballistic stretches.

SUGGESTED RESOURCES

ISBN 0-936070-22-6 Anderson, B. (2000). *Stretching: 20th anniversary* (Rev. ed.). Bolinas, CA: Shelter Publications, Inc.

Bob Anderson, Graduate of California State University in Physical Education. *Stretching with Bob Anderson*. 1987. [DVD]

THIS PAGE INTENTIONALLY LEFT BLANK

TAI CHI

INTRODUCTION

In China it is believed that tai chi can delay aging and prolong life, increase flexibility and strengthen muscles and tendons. Tai chi is a centuries-old Chinese martial art that descends from qigong, an ancient Chinese discipline that has its roots in traditional Chinese medicine. It involves a series of slow, meditative body movements that were originally designed for self-defense and to promote inner peace and calm. Tai chi helps improve the muscular flexibility component of fitness.

EQUIPMENT

One mat per cadet.

ACTIVITY GUIDELINES

Tai Chi shall be conducted by a certified instructor or using a video that is conducted by a certified instructor.

Have the cadets wear clothing that allows free, unrestricted movement.

Keep training at a beginner level to allow all cadets to participate safely.

SUGGESTED RESOURCES

Samuel Barnes. Certified Tai Chi Instructor. *Element: Tai Chi for Beginners*. 2008. [DVD]

THIS PAGE INTENTIONALLY LEFT BLANK

YOGA

INTRODUCTION

Yoga is a popular activity that includes attention to flexibility, relaxation, breathing, and strengthening. Through various yoga poses flexibility and range of motion can be improved. Yoga helps improve the muscular flexibility and muscular strength components of fitness.

EQUIPMENT

One yoga mat per cadet.

ACTIVITY GUIDELINES

Yoga shall be conducted by a certified instructor or using a video that is conducted by a certified instructor.

Have the cadets wear clothing that allows free, unrestricted movement.

Keep training at a beginner level to allow all cadets to participate safely.

SUGGESTED RESOURCES

Colleen Saidman & Rodney Yee. Certified Yoga Instructors. *Rodney Yee's Yoga for Beginners*. 2009. [DVD].

Elena Brower, Certified Yoga Instructor. *Element: AM & PM Yoga for Beginners*. 2008. [DVD].

Elena Brower, Certified Yoga Instructor. *Element: Yoga for Beginners*. 2007. [DVD].

THIS PAGE INTENTIONALLY LEFT BLANK

BASEBALL

OBJECTIVE

While trying to prevent the opposing team from scoring runs, each team tries to score as many runs as possible.

SCORING

One point is awarded as a member completes a circuit around the bases.

DEFINITIONS

Ball. A pitch that is outside the strike zone.

Bunt. When the batter drops the ball as a soft ground ball on the infield.

Double play. When two outs are made on the same play.

Fair ball. The ball when it is legally in play.

Fly ball. A ball batted high into the air.

Force play. When a runner is forced to move to the next base because the batter becomes a runner.

Foul ball. A ball that is hit into foul territory (as illustrated in Figure Q-1).

Foul territory . The area outside the foul lines (as illustrated in Figure Q-1).

Home run. When a batter hits a fair ball over the fence, or circles all bases on a hit inside the fence without getting an out on their way around.

Inning. Consists of a top and a bottom half, during which each team will get to bat and field.

Out. An out can be given due to strikeout, force-out, tag-out, and fly-out:

- **Fly-out.** When a fly ball is caught before it touches the ground or fence.
- **Force-out.** When a fielder touches the base with the ball in their possession before the runner reaches the base during a force play.
- **Strikeout.** When a batter has three strikes.
- **Tag-out.** When a fielder tags a runner with the ball when they are not on a base.

Strike. A pitch, in the strike zone at which the batter does not swing, at which the batter swings and misses, or that the batter hits into foul territory during their first two hits. A foul ball on the third is not considered a strike.

Strike zone. The area over the home plate, between the batter's knees and the midpoint between the top of their shoulders and the top of their pants.

Walk. A batter is awarded first base if four "balls" are pitched to the batter during one time up to bat.

NUMBER OF PLAYERS

Nine players per team.

EQUIPMENT

- Bases (four),
- Bats (two),
- Batter's helmets (two),
- Baseball (extras should be on hand),
- Various gloves, and
- Baseball / softball field.

BASIC RULES

The game consists of nine innings, with three outs per inning (for each team). In the case of a tie, the game will continue for additional innings until a team scores an additional run, breaking the tie. Innings may be reduced due to time constraints.

One team takes the field first, taking up the various positions, to include: pitcher, catcher, first baseman, second baseman, third baseman, shortstop, left fielder, centre fielder, and right fielder.

The other team bats first in the top half of the inning, according to the batting order for their players.

The pitcher attempts to get the batter out, preventing him or her from reaching first base and the subsequent bases. A batter is out if they receive a strikeout, force-out, tag-out, or fly-out.

The batter's objective is to get around the bases before the ball reaches the base. The batter has to attempt to get to first base before the ball reaches the base. While the ball is in play the batter can attempt to reach subsequent bases. Once their play is over the next batter is up.

A team scores a run when a player has safely touched all three bases and has made it back to home base, or hits the ball over the fence resulting in a home run.



Further details on the sport of baseball can be found in *The Sports Rules Book: Essential Rules for 54 Sports* (1998), pp. 25–35.

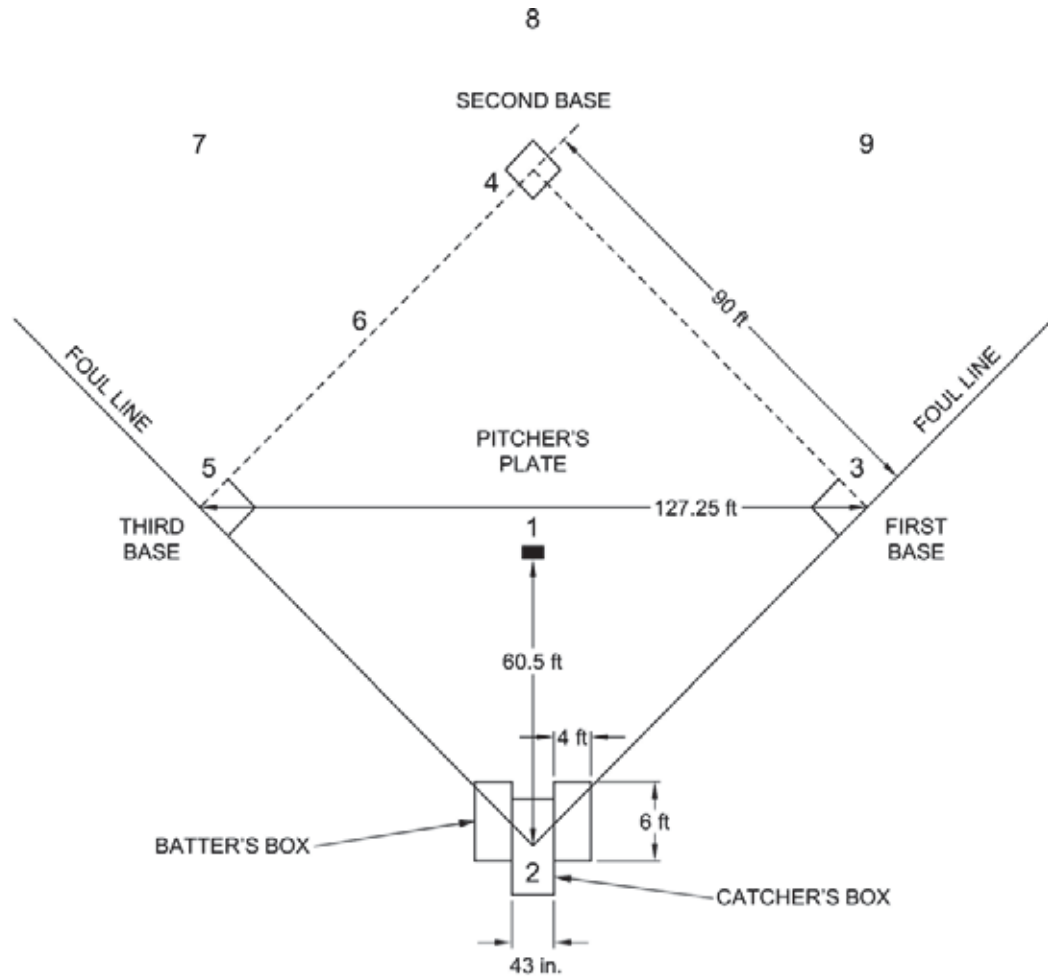

LEGEND

- 1. Pitcher
- 2. Catcher
- 3. First Baseman
- 4. Second Baseman
- 5. Third Baseman
- 6. Shortstop
- 7. Left Fielder
- 8. Centre Fielder
- 9. Right Fielder

Note. From The Sports Rules Book: Essential Rules for 54 Sports (p. 31), by T. Hanlon, 1998, USA: Human Kinetics Publishers, Inc. Copyright 1998 by Human Kinetics Publishers, Inc.

Figure Q-1 Baseball Diamond

BASEBALL SCORE SHEET

Team A

NAMES

Team B

NAMES

Record the number of runs scored by each team for each inning.

	Inning 1	Inning 2	Inning 3	Inning 4	Inning 5	Inning 6	Inning 7	Inning 8	Inning 9	TOTAL
Team A										
Team B										

Note. The scorekeeper must sign the back of the score sheet when completed.

BASKETBALL

OBJECTIVE

Teams attempt to score as many points as possible by passing the basketball through the opposing teams' basket. The team with the highest score at the end of the game is the winner.

SCORING

Field goal. A basket worth two points if scored inside the three-point line and three points if scored from outside the line (as illustrated in Figure R-1).

Free throw. A basket worth one point.

DEFINITIONS

Dribble. Dribbling consists of bouncing the ball on the floor, using only one hand at a time. This can be done while moving on the court or while the player is stationary. Once a player stops dribbling and holds the ball, they cannot dribble again until another player touches the ball.

Double dribble. Dribbling with both hands at once is a violation that results in a turnover or when a player is dribbling, stops and begins again.

Field goal. A two or three-point basket.

Foul. A foul is awarded to a player or coach for misconduct and includes the following:

Away from the ball. Committed by a player in a play not involving the player with the ball.

Blocking and charging. Blocking is illegal contact by a defender, impeding the progress of an offensive player. Charging is illegal contact by an offensive player, pushing or moving into the defender's torso.

Delay of game. When a player prevents the ball from being promptly put into play.

Double personal. Occurs when two opposing players commit personal fouls at the same time.

Double technical. When two opposing players commit technical fouls at the same time.

Elbow. When a player elbows a member of the opposing team.

Excessive timeout. When a team calls a timeout when they have no timeouts left, they are granted a technical foul, but the timeout is allowed.

Face guarding. When a defender places a hand in the face or eyes of an opponent they are guarding from the rear, if the opponent does not have the ball.

Fighting and flagrant fouls.

- **Hand checking.** When a defender uses their hands to check the progress of offensive players when those players are in front of them.
- **Hanging on the rim.** When a player hangs off the rim of the basket, unless it is to protect themselves or another player.
- **Offensive.** If a defender has established legal position in a dribbler's path, the dribbler cannot make contact with the opponent.
- **Personal.** A wide variety of contact fouls including holding, pushing, charging, tripping, and illegally interfering with a player's progress.
- **Player-control.** When the dribbler commits an offensive by charging into a defender who has established legal position, this is called charging.
- **Technical.** Can be on a player, coach, etc. and does not involve contact with the opponent while the ball is alive. Some include profanity, delay of game, excessive time outs, unsportsmanlike conduct, and hanging on the rim.
- **Unsportsmanlike conduct.** Includes actions such as disrespectfully addressing an official; trying to influence an official's decision; arguing with an official; taunting an opponent; etc.

Free throw. A shot given to a player from the free throw line as a result of a foul. It is worth one point.

Pass. The movement of the ball by a player to another player by throwing, batting, or rolling the ball.

Pivot. When a player holding the ball pivots with one foot kept at a point of contact with the floor, while stepping in other directions with the other foot.

Rebound. When a player controls possession of a missed shot, either by a teammate or an opponent.

Sideline pass. When a player throws the ball in from the sidelines of the court.

Traveling. When a player advances on the court with the ball without dribbling it.

Violations. When a player breaks a rule without contact. These include: basket interference and goaltending, double dribble, faking a free throw, kicking or hitting the ball, out of bounds, shot clock, traveling and throw in.

NUMBER OF PLAYERS

Five players per team on the court at a time.

EQUIPMENT

- Basketball,
- Gymnasium / outdoor court, and
- Nets (two).

BASIC RULES

The game consists of four 8-minute quarters.

Teams will consist of a point guard, an off guard / shooting guard, a small forward, a power forward and a centre / post.

The game begins with what is known as a “jump ball”. A player from each team will meet face to face at the centre of the court. When the official tosses the ball straight up between them, both players will attempt to catch or hit the ball to a teammate.

Once the game has begun, the player in possession of the ball must dribble at all times in order to continue to move forward along the court. The player may pass the ball at any time to a teammate.

If a player in possession of the ball stops moving, they may only pivot on the spot or take a maximum of three steps and then pass or shoot the ball towards the basket.

If a team scores, the opposing team will gain possession of the ball. The opposing team throws the ball inbounds to put the ball back into play. On this throw-in, the thrower cannot step on or over the line while still in possession of the ball.

During the game, if the ball is tossed out of bounds or a person is fouled, the opposite team will gain the ball where a free throw will be awarded or a sideline pass will take place.



Further details on the sport of basketball can be found in *The Sports Rules Book: Essential Rules for 54 Sports* (1998), pp. 37–46.

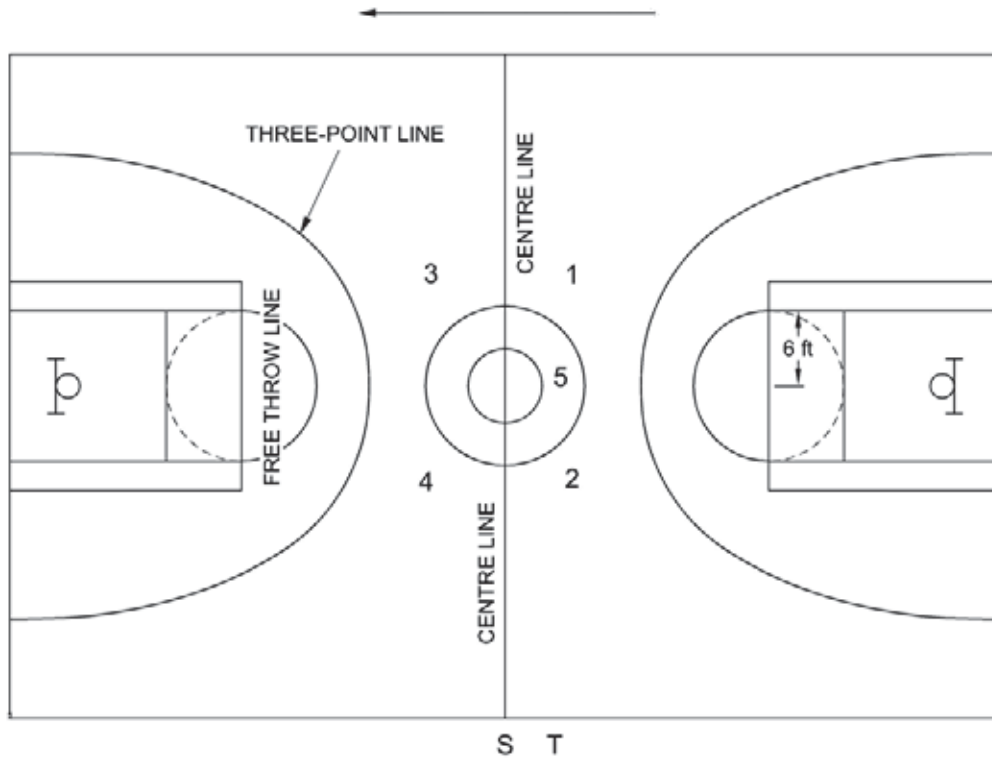

LEGEND

- 1. Point Guard
- 2. Off Guard or Shooting Guard
- 3. Small Forward
- 4. Power Forward
- 5. Centre or Post
- S Scorekeeper
- T Timekeeper

Note. From The Sports Rules Book: Essential Rules for 54 Sports (p. 41), by T. Hanlon, 1998, USA: Human Kinetics Publishers, Inc. Copyright 1998 by Human Kinetics Publishers, Inc.

Figure R-1 Basketball Court

THIS PAGE INTENTIONALLY LEFT BLANK

FLOOR HOCKEY

OBJECTIVE

Teams attempt to score as many points as possible by shooting the ball into the opposing team's net. The team with the highest score at the end of the game is the winner.

SCORING

A player shooting the ball off their stick into the net, scores a goal.

DEFINITIONS

Faceoff. When two players meet to try to gain possession of the ball when the referee drops it.

Goal. A point / goal is scored when a player gets the ball across the goal line.

Rebound. A ball that bounces off the goalkeeper or the goal post.

Save. When the goalkeeper prevents a goal from being scored.

NUMBER OF PLAYERS

Six players per team on the floor at one time.

EQUIPMENT

- Hockey ball,
- Hockey sticks for the number of players,
- Goalie sticks (two),
- Goalie equipment, and
- Hockey nets (two).

BASIC RULES

A game consists of three 20-minute periods.

Teams will consist of a goalkeeper, three forwards—centre, left wing, and right wing—and two defencemen.

A game begins with a faceoff between two opposing players where an official drops the ball at the centre of the playing field / gymnasium.

Players advance with the ball while stickhandling the ball or passing it to fellow teammates. The ball must be in motion at all times.

Every time a goal is scored, the players return to the initial set-up for a faceoff at the centre of the area of play.

If an attacker in the team's attacking zone causes the play to stop, a faceoff will occur at the nearest faceoff spot in the neutral zone (the central portion between the blue lines).

If a defender in the team's defensive zone causes the play to stop, a faceoff occurs at the point of stoppage.



Further details on the sport of hockey can be found in *The Sports Rules Book: Essential Rules for 54 Sports* (1998), pp. 159–168. These rules then must be adapted for floor hockey.

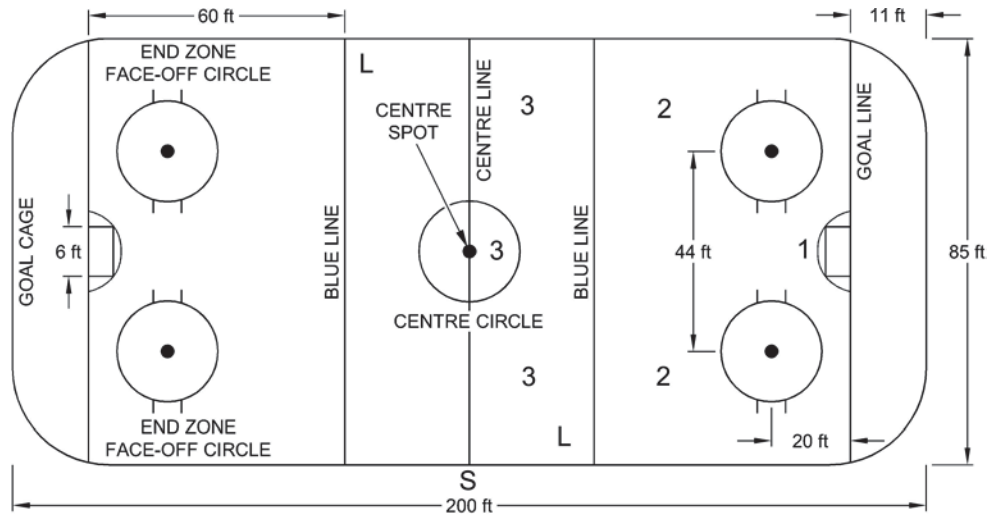

LEGEND

- 1. Goalkeeper
- 2. Defenseman
- 3. Forward
- S Scorekeeper
- L Linesman

Note. From The Sports Rules Book: Essential Rules for 54 Sports (p. 162), by T. Hanlon, 1998, USA: Human Kinetics Publishers, Inc. Copyright 1998 by Human Kinetics Publishers, Inc.

Figure S-1 Hockey Set-Up

FLOOR HOCKEY SCORE SHEET

Team A

NAMES

Team B

NAMES

Record the number of goals achieved by each team within each period.

First Period

Second Period

Third Period

Team A	Team B	Team A	Team B	Team A	Team B
TOTAL		TOTAL		TOTAL	

Note. The scorekeeper must sign the back of the score sheet when completed.

FOOTBALL (FLAG / TOUCH)

OBJECTIVE

Teams attempt to score as many points as possible through touchdowns. The team with the highest score at the end of the game is the winner.

SCORING

Touchdown. Worth six points and scored when a player carries the ball into the opponent's end zone or catches the ball in the opponent's end zone before it touches the ground. After a touchdown has been scored, the scoring team can make a one-point convert attempt from the 5-yard line (approximately 4-1/2 m / 15 feet) or a two-point convert attempt from the 10-yard line (approximately 11 m / 36 feet).

Safety. An interception return to the opponent's end zone, on any extra-point play by the defence, will result in the defence scoring two points, plus they will gain possession for the next series at their own 5-yard (4-1/2 m / 15 feet) line.

Rouge. A team is awarded one point when they legally kick the ball into the opponent's end zone and the ball is not brought out of the end. To score off a kick off, the ball must land in the field of play or in the end zone before it goes out of bounds.

DEFINITIONS

Convert. A pass or a run attempt; no kicking allowed.

Dead ball. When the ball is no longer in play and the play is over.

First down. Is a new set of three downs. Each team, when they are the offence, get three downs in which to make a play.

Forward pass. When the ball is intentionally thrown or handed towards the opponent's goal line.

Fumble. When a player loses possession of the ball while the play is still in progress.

Punt. When the ball is deliberately dropped and then kicked with the foot or leg before the ball touches the ground.

Scrimmage line. The line where the players line up for the snap.

Snap. When a player designated as the centre passes the ball between the legs to the quarterback.

Touchback. Occurs when the ball is dead on or behind a team's own goal line, provided the ball's force came from an opponent and it is not a touchdown.

NUMBER OF PLAYERS

Seven players per team on the field at one time for touch football. Eight players per team on the field at one time for flag football.

EQUIPMENT

- Football,
- Flags / ribbons,
- Field, and
- Safety / protective equipment.

BASIC RULES

The game consists of four 15-minute quarters.

Whichever team takes first possession of the ball is the offence. The other team becomes the defence.

The offence has three downs to obtain 10 yards, keep possession of the ball, and attempt to score. If they do not gain 10 yards and a first down, possession of the ball changes and that team then becomes the offence.

To begin the game, a team will kickoff from their own 45-yard line (or on a non-regulation field, ten yards back from the centre line). The remaining players of the team must stay behind the kickoff line until the ball has been kicked.

At the kickoff, all players of the receiving team must be at least 20 yards away from the kickoff line.

To begin a series of three downs, the ball will be placed on the ground at the point where the ball carrier was touched after the kickoff. All members of the offensive team will line up on or behind the line of scrimmage. A player designated as the centre will begin the play by snapping the ball between the legs to the quarterback who must receive the ball from a minimum of five yards behind the line of scrimmage.

The defensive players must be at least one yard from the line of scrimmage on the opposite side during the snap.

All players on the offence, with the exception of the centre, can be in motion prior to the snap. They may not cross the line of scrimmage until after the snap.

In touch football, play is terminated when a defender touches the ball carrier with the hand. In flag football, play is terminated when a defender removes the ball carrier's flag.

The defensive team will have one player during scrimmage play, called the rusher, who will pursue the quarterback after the ball is snapped. The rusher must be at least five yards away from the line of scrimmage at the time the ball is snapped and cannot be lined up directly with the centre of the opposing team.

No player is permitted to block or obstruct the rusher in the direct path to the quarterback.

Teams are only permitted one forward pass on each scrimmage play. Forward passes are not permitted on kickoffs or after punts.

The team that plays defence at the beginning of the first half receives possession at the start of the second half.

If a team fails to make it across midfield within three plays, possession of the ball changes.

Once a ball is punted, the team gives up possession of the ball.

There are no fumbles in touch football.

Must be played as non-contact. Blocking and tackling are not allowed.



Further details on the sport of football can be found in *The Sports Rules Book: Essential Rules for 54 Sports* (1998), pp. 125–136. These rules must be adapted for flag / touch football. Some of these modifications can be found on pp. 132–133. Further rules may be found in the *National Football Federation's Touch Football Rule Book*.

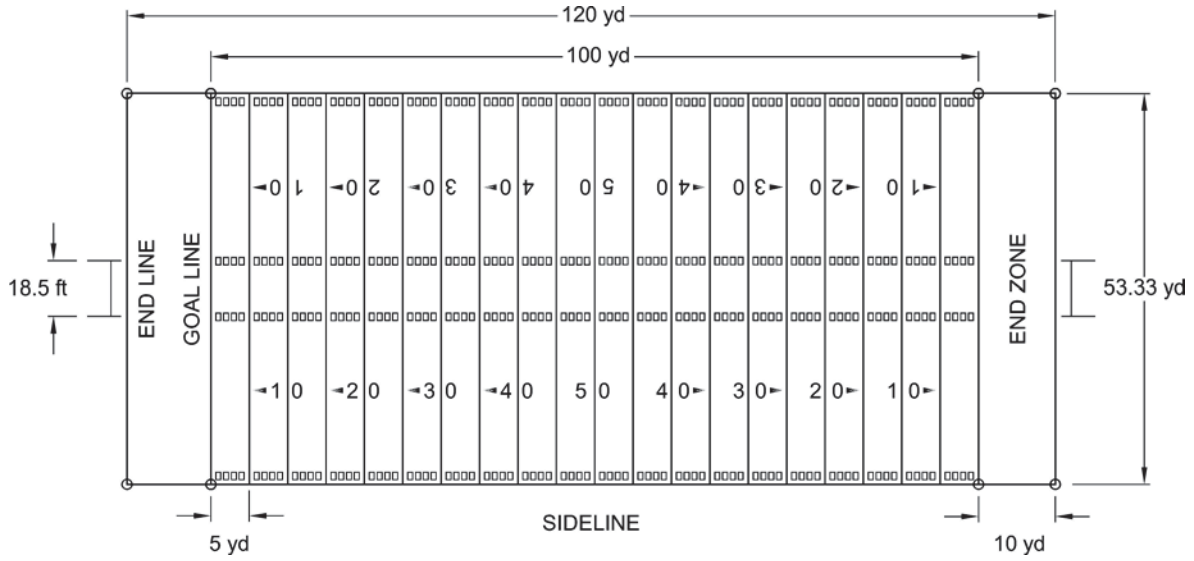

Note. From *The Sports Rules Book: Essential Rules for 54 Sports* (p. 129), by T. Hanlon, 1998, USA: Human Kinetics Publishers, Inc. Copyright 1998 by Human Kinetics Publishers, Inc.

Figure T-1 Football Field

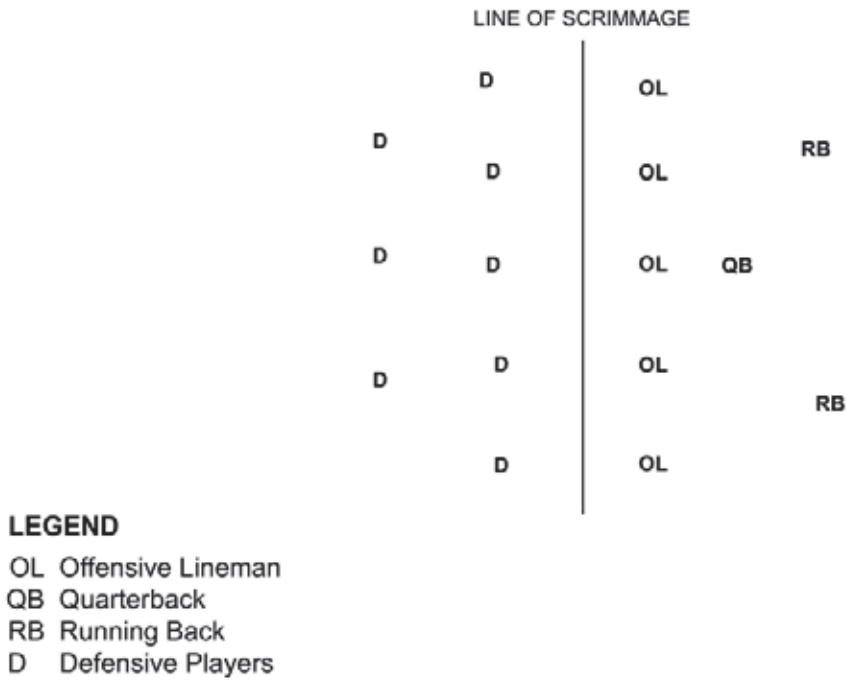

LEGEND
 OL Offensive Lineman
 QB Quarterback
 RB Running Back
 D Defensive Players

Note. Created by Director Cadets 3, 2007, Ottawa, ON: Department of National Defence.

Figure T-2 Line of Scrimmage

FOOTBALL SCORE SHEET

Team A	
NAMES	

Team B	
NAMES	

Record the number of points awarded to each team within each quarter.

A touchdown is worth six points. A safety is worth two points. A rouge is worth one point.

First Quarter		Second Quarter		Third Quarter		Fourth Quarter	
Team A	Team B	Team A	Team B	Team A	Team B	Team A	Team B
TOTAL		TOTAL		TOTAL		TOTAL	

Note. The scorekeeper must sign the back of the score sheet when completed.

THIS PAGE INTENTIONALLY LEFT BLANK

LACROSSE

OBJECTIVE

Teams attempt to score as many points as possible by passing the ball into the opposing team's goal. The team with the highest score at the end of the game is the winner.

SCORING

A goal is scored when the ball passes completely over the goal line, between the posts and under the cross bar of the opponent's goal.

DEFINITIONS

Blocking. Occurs when one player moves into the path of an opponent with the ball without giving the opponent a chance to stop or change direction without contact.

Critical scoring area. An area at each end of the field, where the attacking team shoots for a goal.

Deputy. A player on the defensive goalkeeper's team who may enter the goal circle when his or her team is in possession of the ball and the goalkeeper is out of the goal circle.

Draw. With two opposing players toeing the centreline, holding their crosses in the air, parallel to the centreline. The umpire places the ball between the players and when they call ready the players pull their sticks up and away, lifting the ball into the air. All other players must be outside the centre circle for the draw.

Free space to goal. The path to the goal within the critical scoring area.

Marking. Guarding an opponent within a stick's length.

Penalty lane. The path to the goal that is cleared when a free position is awarded to the attacking team within the critical scoring area in front of the goal line.

Pick. A technique used by a player without the ball to force an opponent to take a different direction. The player must give the opponent time to see the pick and react to it.

Throw. Two players of opposing teams stand 1 m (3-1/3 feet) apart; the umpire stands 4–8 m (13–26 feet) away, and throws the ball into the air and the players take it as they move toward the field. No other player can be within 4 m (13 feet) of the players taking the throw.

NUMBER OF PLAYERS

Twelve players per team on the field at one time.

EQUIPMENT

- Ball,
- Field crosses for the number of players,
- Goalkeeper's crosse (two),
- Goalkeeper's helmet, face mask, and throat and chest protector (two of each), and
- Mouth guards for the number of players.

BASIC RULES

The game consists of two 30-minute halves.

The team consists of a goalkeeper, point, cover-point, third man, left defence wing, right defence wing, left attack wing, right attack wing, third home, second home, first home, and centre (as illustrated in Figure Z-1).

The game begins with a draw.

The team in possession of the ball attempts to score goals by advancing the ball down the field. This is done by carrying, throwing, rolling, or batting the ball.

If the ball goes out of bounds, it is given to the closest player. If two players of opposing teams are an equal distance from the ball, the game is continued with a throw.

Only one player can be in the goal circle at a time. This can only be the goalkeeper or the deputy.

Within the goal circle, the goalkeeper must clear the ball within 10 seconds. This can be done with the goalkeeper's crosse, hands, or body.

After each goal, the ball is put back into play with a draw.



Further details on the sport of lacrosse can be found in *The Sports Rules Book: Essential Rules for 54 Sports* (1998), pp. 179–186.

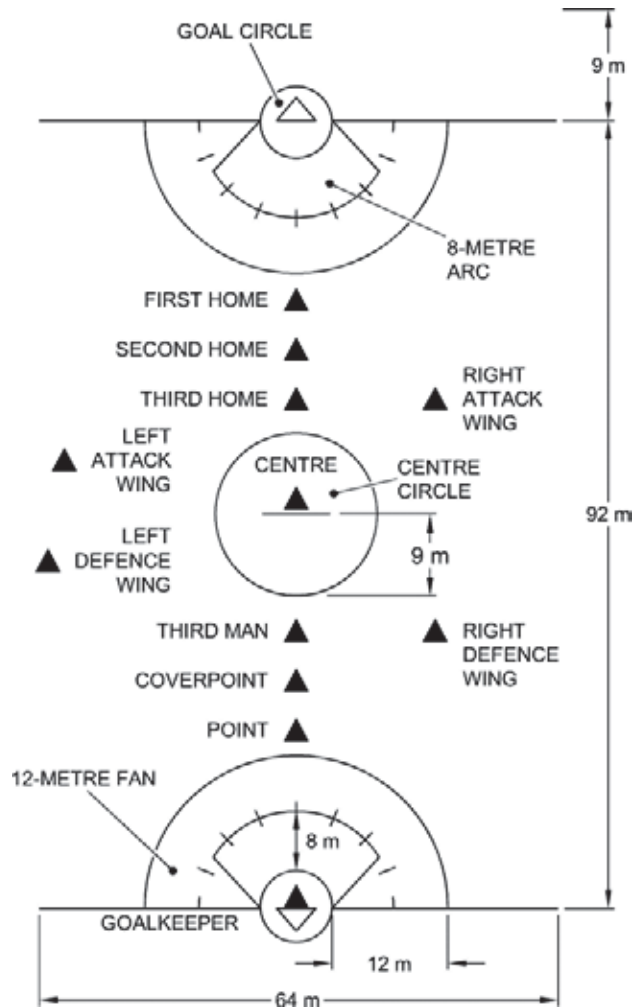

Note. From *The Sports Rules Book: Essential Rules for 54 Sports* (p. 182), by T. Hanlon, 1998, USA: Human Kinetics Publishers, Inc. Copyright 1998 by Human Kinetics Publishers, Inc.

Figure U-1 Lacrosse Field

RINGETTE (OFF-ICE VERSION)

OBJECTIVE

Teams attempt to score as many points as possible by getting the ring in the opposing team's net. The team with the highest score at the end of the game is the winner.

SCORING

One point for every time a ring passes into the opposing team's net.

NUMBER OF PLAYERS

Six players per team on the floor at one time.

EQUIPMENT

- Nets (two),
- Safety equipment,
- Rubber ring,
- Straight sticks for number of players, and
- Goalkeeper's sticks and masks (two of each).

BASIC RULES

The game is played in two 20-minute periods. Teams consist of a goalkeeper, two defencemen, and three forwards. The stick is placed inside the ring to play. The ring is passed up the playing area in order to get the ring in the opposing team's net.

Play begins with the visiting team being given a free pass in the centre free pass circle (which is like a faceoff circle in hockey). Free passes are used in ringette to restart play. The ring is placed in the free pass circle for this and one player gets to take possession, having five seconds to pass the ring to a teammate. Shots on goal are allowed from the free pass. If the ring is within the goal crease, the only player who is allowed to touch it is the goalie. The goalie will pick up the ring and throw it like a Frisbee to a teammate but it cannot be thrown beyond the blue line. The goalkeeper can also hit the ring with their stick or foot to move it out of the goal crease.



Further details on the sport of ringette can be found at <http://www.ringette.ca>

TEAM A'S DEEP DEFENSIVE ZONE

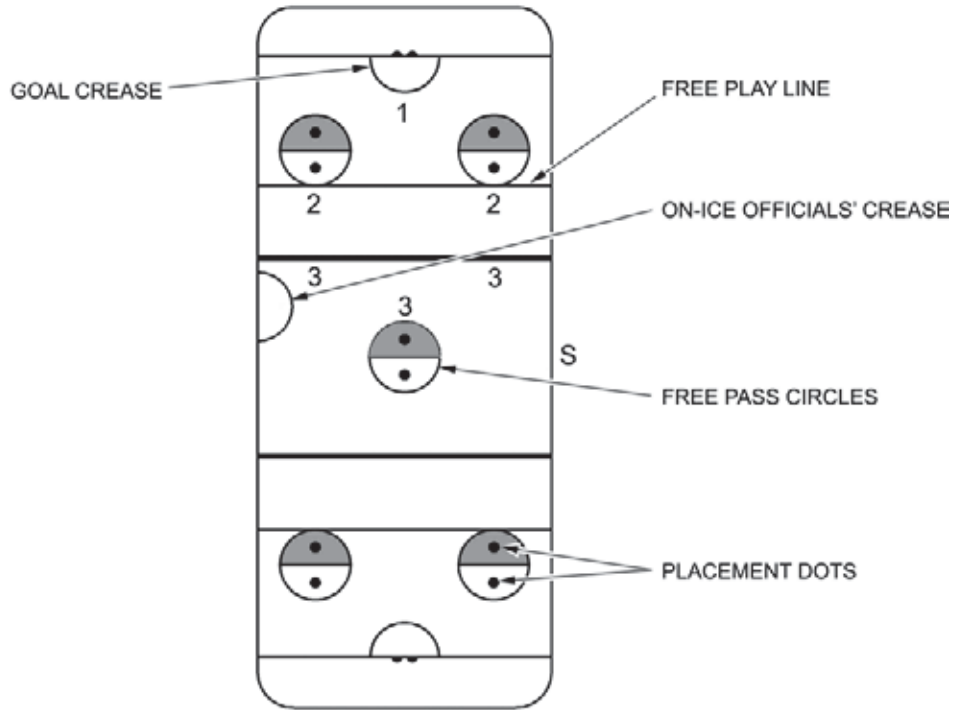

TEAM A'S DEEP OFFENSIVE ZONE

LEGEND

- 1. Goalkeeper
- 2. Defenceman
- 3. Forward
- S Scorekeeper

Note. From How Ringette is Played, by Ringette Canada, n.d. Retrieved October 30, 2006, from <http://www.ringette.ca/e/about/played.htm>

Figure V-1 Ringette Ice / Playing Field

RINGETTE SCORE SHEET

Team A

NAMES

Team B

NAMES

Record the number of goals achieved by each team within each period.

First Period

Team A	Team B
TOTAL	

Second Period

Team A	Team B
TOTAL	

Note. The scorekeeper must sign the back of the score sheet when completed.

THIS PAGE INTENTIONALLY LEFT BLANK

SOCCER

OBJECTIVE

Teams attempt to score as many points as possible by getting the ball in the opposing team's net. The team with the highest score at the end of the game is the winner.

SCORING

A point is scored for every goal made into the net that completely crosses the goal line.

DEFINITIONS

Corner kick. Awarded to the opposing team when players kick the ball over their own goal line. All opposing players must be at least 10 yards (9 m / 29.5 feet) from the ball for a corner kick.

Dribble. To move the ball with the feet in a continuous motion by passing the ball from one foot to the other.

Foul. Results in a direct or indirect free kick for the opposing team at the spot where the foul occurred. Fouls include:

- kicking, tripping or pushing;
- jumping into an opponent;
- violently or dangerously charging an opponent;
- striking an opponent with the hand, arm, or elbow;
- holding an opponent's body or clothing;
- playing the ball anywhere on the arm;
- going offside;
- obstructing an opponent by deliberately blocking their path;
- kicking too high, putting an opponent in danger;
- bending low, putting themselves in danger;
- unsportsmanlike conduct;
- charging an opponent when the ball is no more than one step away;
- charging into the goalkeeper while in the goal area, preventing them from playing the ball or retaining possession of the ball; and
- the goalkeeper taking more than four steps before releasing the ball.

Free kick. Direct free kicks are awarded for fouls on a player; indirect free kicks are awarded for other violations made by the opposing team.

Goal kick. Occurs when a player kicks the ball over the opposing team's goal line. The opposing team is awarded the goal kick. Opposing players must be outside the penalty box area; either the goalkeeper or another player may kick the ball. The ball must be kicked beyond the penalty box area to be put into play. The player who performs the goal kick cannot touch the ball again until another player has done so.

Heads the ball. When a player hits the ball with their head.

Penalty kick. Is awarded to a team when an opposing player commits an intentional foul. All players, except the kicker and the goalkeeper, must stand outside the penalty area, at least ten yards (9 m / 29.5 feet) from the ball. The goalkeeper must stand on the goal line and not move their feet until the kick is made. If a goal is not scored and the ball goes out of bounds after being touched by the goalkeeper, the attacking team gets a corner kick.

Throw-in. Is awarded to a team when the ball goes over the sideline and was last touched by an opponent. A player throws the ball in from over their head, keeping both feet on the ground while releasing the ball. At least part of each foot must be on or behind the sideline.

NUMBER OF PLAYERS

Up to 11 players per team on the field at one time.

EQUIPMENT

- Soccer ball,
- Nets (two), and
- Field or gymnasium.

BASIC RULES

The game consists of two 45-minute halves. Teams will consist of a goalkeeper, defenders, midfielders, and forwards, or strikers. The game begins with a kickoff at the centre of the playing field, where the ball is placed in a stationary position at the centre spot. All players must be on their team's half of the playing field before the kickoff takes place. The player who kicks off may not touch the ball again until another player has. Players have to move the ball up the field with their feet, head, or chest. They may not touch the ball with their hands. The game continues in this manner, with players dribbling the ball and moving it toward the opposing team's goal in order to score.

When a goal is scored the play begins again with the team losing the goal taking the kickoff.

A goal may not be scored directly off a kickoff, goal kick, or throw-in.



Further details on the sport of soccer can be found in *The Sports Rules Book: Essential Rules for 54 Sports* (1998), pp. 237–245.

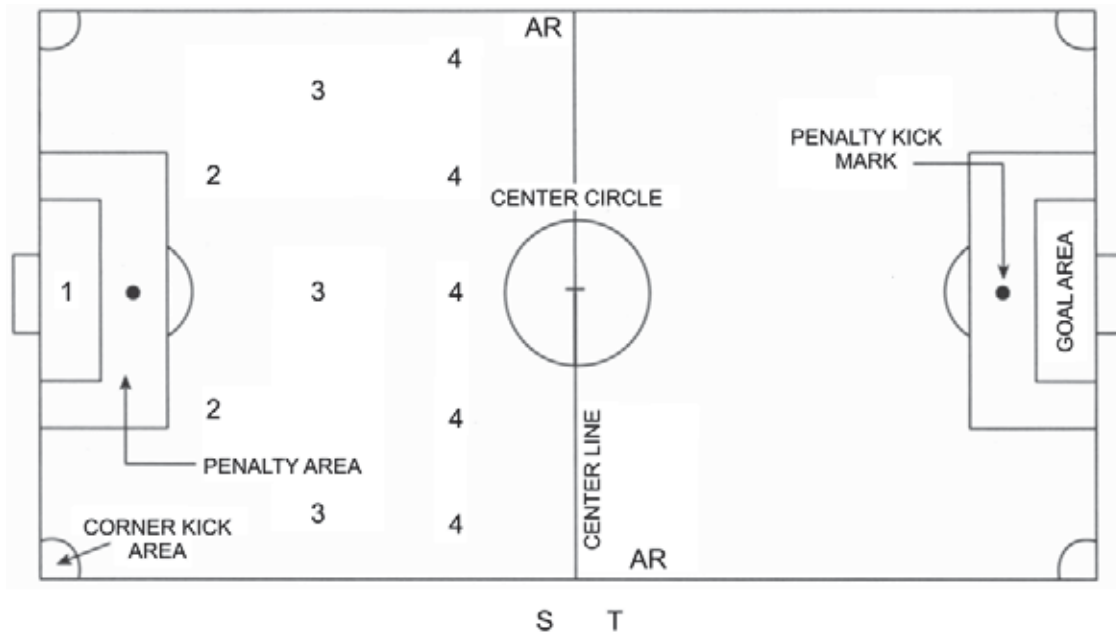

LEGEND

- 1. Goalkeeper
- 2. Defender
- 3. Midfielder
- 4. Forward
- S Scorekeeper
- T Timekeeper
- AR Assistant Referee

Note. From The Sports Rules Book: Essential Rules for 54 Sports (p. 241), by T. Hanlon, 1998, USA: Human Kinetics Publishers, Inc. Copyright 1998 by Human Kinetics Publishers, Inc.

Figure W-1 Soccer Field

SOCCER BASEBALL / KICKBALL

OBJECTIVE

While trying to prevent the opposing team from scoring runs, each team tries to score as many runs as possible. A run is scored when a team's player runs (in a counter-clockwise direction) and steps on all three bases and the home plate.

SCORING

One point is awarded as a member completes a circuit around the bases. A game lasts five innings where the team with the highest score wins, unless there is a tie. In the case of a tie the game will continue for additional innings until a team scores an additional run, breaking the tie.

DEFINITIONS

Double. A kick in which the batter safely runs to second base.

Double play. When two outs are made on the same play.

Fair ball. The ball when it is legally in play.

Force play. Occurs when a runner is forced to advance to the next base because the batter becomes a runner.

Foul play. Any ball hit into foul territory.

Foul territory. The area outside the foul lines.

Home run. When a batter kicks a fair ball over the fence or circles all bases on a kick that was inside the fence.

Lead off. When a runner leads off a base before the ball has left the pitcher's hand.

Legal touch. When a defensive player tags a runner with the ball while the runner is not on a base. This results in an out.

Out. There are a number of types of outs, which include:

- **Fly-out.** When a fly ball is caught before it touches the ground or fence.
- **Force-out.** When a fielder touches the base with the ball in their possession before the runner reaches.
- **Strikeout.** When a batter has three strikes.
- **Tag-out.** When a fielder tags a runner with the ball when they are not on a base. This is also known as a legal touch.

Steal. When a runner attempts to steal a base during a pitch to the kicker.

Tag-up rule. If the ball is caught in the air after the kicker has kicked it, the kicker is out. Other players who are on bases must touch the base they were on after the ball is caught before they can run to the next base.

NUMBER OF PLAYERS

Nine players per team on the field at one time.

EQUIPMENT

- Soccer ball,
- Baseball / softball field or a gymnasium or field, and
- Bases / pylons (four).

BASIC RULES

The game consists of five innings, with three outs per inning (for each team).

One team takes the field first, taking up the various positions, to include a pitcher, catcher, first baseman, second baseman, third baseman, shortstop, left fielder, centre fielder, right fielder, and other fielders depending on the number of players.

When pitching, the ball must touch the ground at least once and cannot be higher than one foot (30 cm) above the plate when it gets to the kicker. The ball should be pitched to roll as smoothly as possible.

A ball is put into play once the pitcher rolls the ball toward home plate and the kicker has attempted to kick the ball.

The kicker must wait for the ball to be within 1 m of the home plate before they can attempt to kick the ball.

Leading off and stealing bases is not allowed. Bunts are not permitted.

The kicker at home plate must kick the ball with the leg (below the knee) or foot.

Field players can tag the runner out while either carrying the ball or throwing it at the runner and making contact. Thrown balls are to hit below the waist.

A runner who leaves their base before the pitch reaches home plate or before the pitch is kicked, is out and the ball is considered dead.



Further details on the sport of soccer baseball / kickball can be found at <http://www.kickball.com>

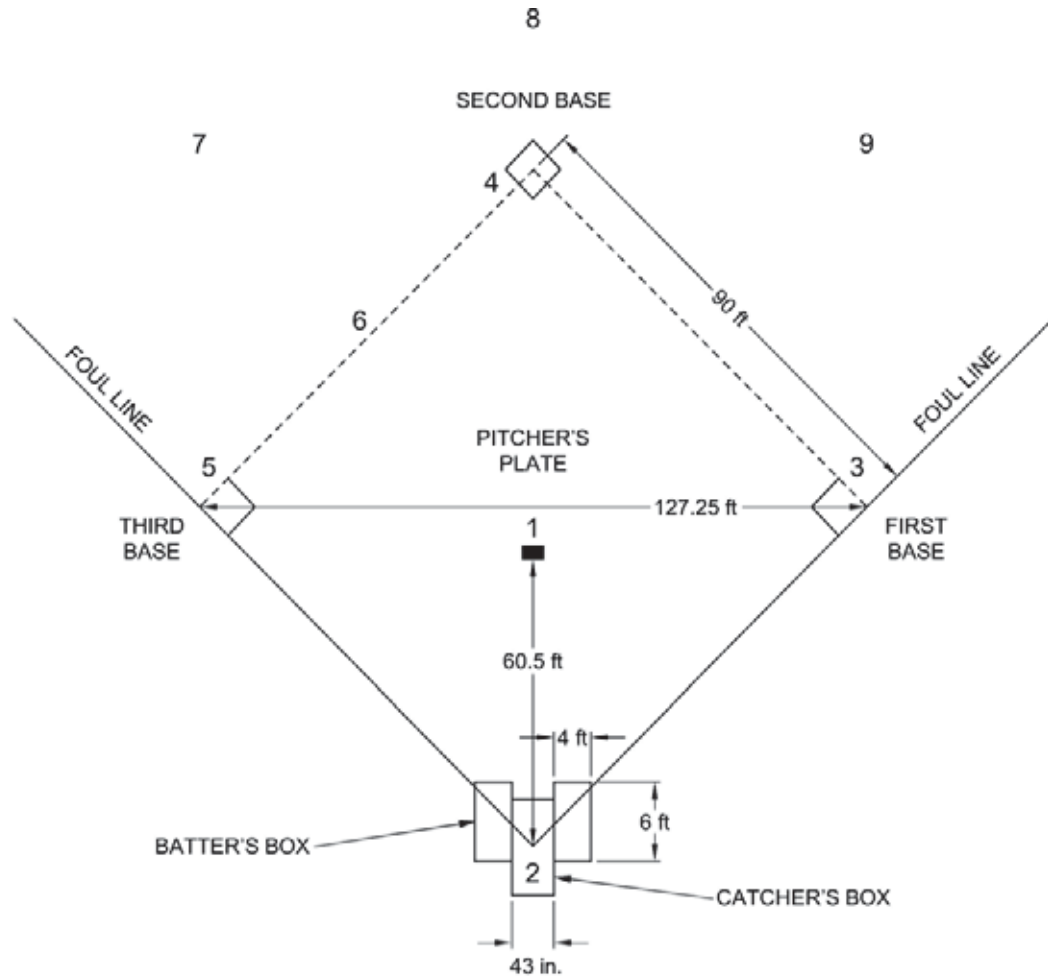

LEGEND

- 1. Pitcher
- 2. Catcher
- 3. First Baseman
- 4. Second Baseman
- 5. Third Baseman
- 6. Shortstop
- 7. Left Fielder
- 8. Centre Fielder
- 9. Right Fielder

Note. From The Sports Rules Book: Essential Rules for 54 Sports (p. 31), by T. Hanlon, 1998, USA: Human Kinetics Publishers, Inc. Copyright 1998 by Human Kinetics Publishers, Inc.

Figure X-1 Baseball Diamond (used for soccer baseball)

SOCCKER BASEBALL / KICKBALL SCORE SHEET

Team A

NAMES

Team B

NAMES

Record the number of runs scored by each team for each inning.

	Inning 1	Inning 2	Inning 3	Inning 4	Inning 5	TOTAL
Team A						
Team B						

Note. The scorekeeper must sign the back of the score sheet when completed.

SOFTBALL

OBJECTIVE

While trying to prevent the opposing team from scoring runs, each team tries to score as many runs as possible. A run is scored when a team's player runs (in a counter-clockwise direction) and steps on all three bases and the home plate.

SCORING

One point is awarded as a member completes a circuit around the bases. A game lasts seven innings where the team with the highest score wins, unless there is a tie. In the case of a tie the game will continue for additional innings until a team scores an additional run, breaking the tie.

DEFINITIONS

Ball. A pitch that is outside the strike zone.

Bunt. When a batter hits the ball by letting the ball meet the bat to drop as a soft ground ball on the infield.

Double play. When two outs are made on the same play.

Fair ball. The ball when it is legally in play.

Fake tag. A form of obstruction of a runner by a fielder who neither has the ball nor is about to receive it. The umpire will award the runner the base they would have made, if the obstruction had not been made.

Fly ball. A ball batted high into the air.

Fly-out. A fly ball that is caught before it touches the ground or the fence.

Force play. When a runner is forced to advance to the next base because the batter becomes a runner.

Foul play. Any ball hit into foul territory.

Foul territory. The area outside the foul lines (as illustrated in Figure AD-1).

Home run. When a batter hits a fair ball over the fence or circles all bases on a ball that was hit inside the fence.

Inning. An inning consists of a top and a bottom. During either the top or bottom half each team will get the opportunity to bat and field accordingly.

Interference. This occurs when an offensive player impedes or confuses a defensive player as they are trying to make a play. Interference can be physical or verbal.

Lead off. When a runner leads off a base once the ball has been batted, touches the ground, or reaches home plate, but must return to the base if the ball is not hit.

Out. There are a number of types of outs, which include:

- **Fly-out.** When a fly ball is caught before it touches the ground or fence.
- **Force-out.** When a fielder touches the base with the ball in their possession before the runner reaches.
- **Strikeout.** When a batter has three strikes.
- **Tag-out.** When a fielder tags a runner with the ball when they are not on a base. This is also known as a legal touch.

Overslide. When a player over slides first base when running. It is allowed at first base, but at second and third base, the runner may be tagged out.

Steal. In fast-pitch, a runner may attempt to steal a base during a pitch to the batter.

Strike zone. The area over the home plate, between the batter's back shoulder and front knee.

Walk. A batter is awarded first base if four "balls" are pitched to the batter during one time up to bat.

NUMBER OF PLAYERS

10 players per team on the field at a time if team is not batting.

EQUIPMENT

- Bases (four),
- Bat,
- Batter's helmets,
- Softball,
- Various gloves for the number of players, and
- Baseball / softball field.

BASIC RULES

The game consists of seven innings, with three outs per inning (for each team).

One team takes the field first, taking up the various positions, to include a pitcher, catcher, first baseman, second baseman, third baseman, shortstop, left fielder, centre fielder, right fielder, and extra fielder.

The other team bats first in the top half of the inning, according to the batting order for their players.

The pitcher attempts to get the batter out, preventing them from reaching first base and the subsequent bases.

The pitcher must use an underhand pitch.

A batter is out if they receive a fly-out, force-out, strikeout or tag-out.

The batter's objective is to get around the bases without being tagged and before the ball reaches the base.

A team scores a run when a player has safely touched first, second, and third base, and has made it back home or hits the ball over the fence.



Further details on the sport of softball can be found in *The Sports Rules Book: Essential Rules for 54 Sports* (1998), pp. 247–259.

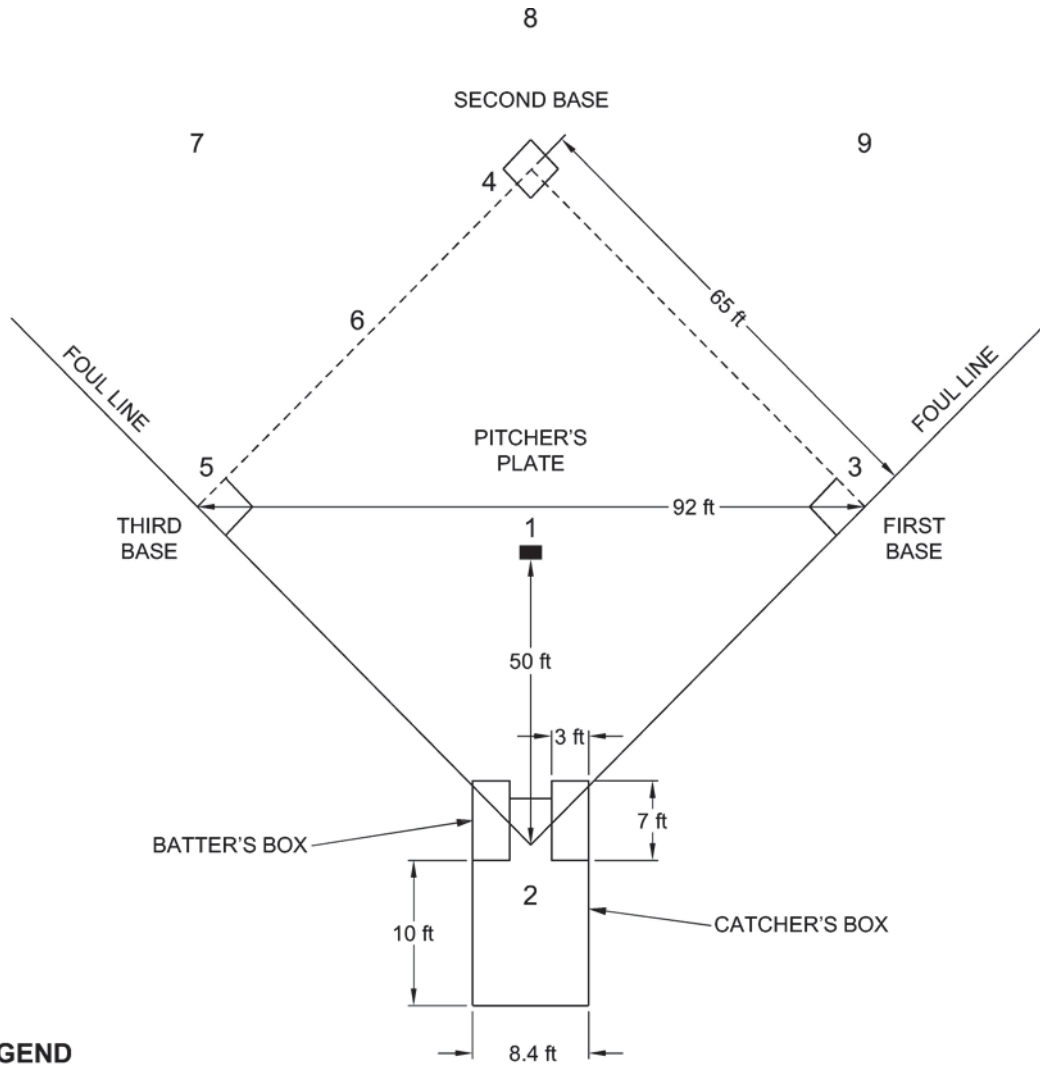

LEGEND

- 1. Pitcher
- 2. Catcher
- 3. First Baseman
- 4. Second Baseman
- 5. Third Baseman
- 6. Shortstop
- 7. Left Fielder
- 8. Centre Fielder
- 9. Right Fielder

Note. From The Sports Rules Book: Essential Rules for 54 Sports (p. 251), by T. Hanlon, 1998, USA: Human Kinetics Publishers, Inc. Copyright 1998 by Human Kinetics Publishers, Inc.

Figure Y-1 Softball Field

SOFTBALL SCORE SHEET

Team A

NAMES

Team B

NAMES

Record the number of runs scored by each team for each inning.

	Inning 1	Inning 2	Inning 3	Inning 4	Inning 5	Inning 6	Inning 7	TOTAL
Team A								
Team B								

Note. The scorekeeper must sign the back of the score sheet when completed.

THIS PAGE INTENTIONALLY LEFT BLANK

ULTIMATE FRISBEE

OBJECTIVE

Teams attempt to score as many points as possible by catching a pass in the opponent's end zone. The team with the highest score at the end of the game is the winner. Ultimate Frisbee helps improve the cardiovascular and muscular strength components of fitness.

SCORING

Points are awarded to a team when a player catches a pass in the opponent's end zone. A typical game is scored to 15 points.

DEFINITIONS

Clearing. To get out of the area where the thrower wants to pass the Frisbee.

Cut. An attempt to get free of other players in order to receive a pass.

Force. To make it difficult for the thrower to throw the Frisbee in a certain direction in an attempt to try to get them to pass it the other way.

Huck. A long high pass that is nearly the length of the field.

Layout. When a player dives to catch or intercept the Frisbee.

Poach. When a defender moves away from their marker to try to intercept a pass to another player.

Swing. A lateral pass across the pitch, instead of upfield.

Switch. When two defenders exchange the offensive players they were marking.

NUMBER OF PLAYERS

Seven players per team on the field at one time.

EQUIPMENT

- One Frisbee, and
- Pylons to mark boundaries.

BASIC RULES

The game is played in two halves. There is no time set for the halves. Halftime begins when one team reaches eight points.

Each team lines up on the front of their respective end zone line to initiate play. The defence will then throw the Frisbee to the offence.

The Frisbee may be played in any direction by passing to teammates. Players must remain stationary when they hold the Frisbee. It must be passed to other players on the field that is closer to the opponent's end zone.

A player cannot hold the Frisbee for longer than 10 seconds. The defender, who is guarding the player holding the Frisbee (staller), must count out the stall count.

When a pass is not completed due to being out of bounds, being dropped, blocked or intercepted, etc. the defence takes possession of the Frisbee and becomes the offence.

To bring the Frisbee back into play it must be brought to the point on the pitch where it went out, or the nearest point where a defender touched it.

There is no physical contact allowed between the players.

A throw can be made without stopping if it is within three steps of the catch. The thrower cannot change direction or speed up after catching the Frisbee.

After halftime the teams will switch ends of the playing field.



Further details on the sport of ultimate Frisbee can be found at <http://www.whatisultimate.com> or <http://www.upa.org/ultimate>

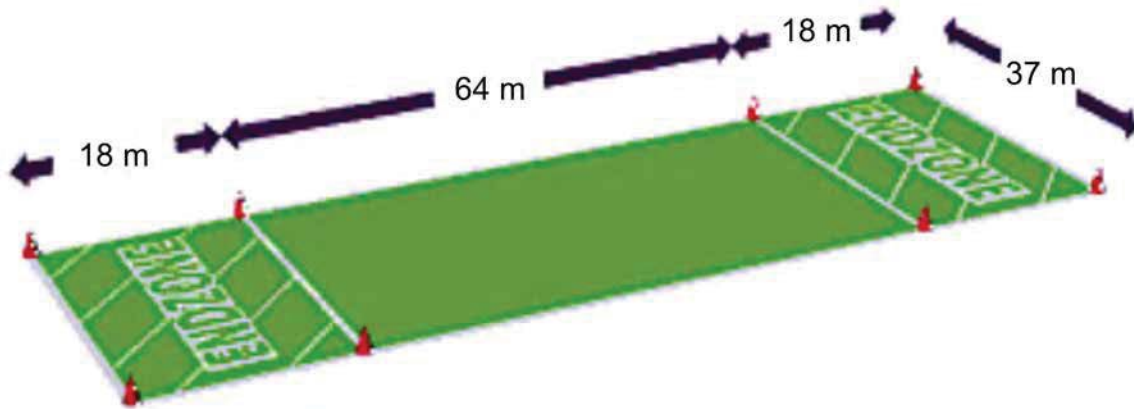

Note. From What is Ultimate Frisbee, by What is Ultimate, n.d. Retrieved October 30, 2006, from http://www.whatisultimate.com/what/what_game_en.html

Figure Z-1 Ultimate Frisbee Field

ULTIMATE FRISBEE SCORE SHEET

Team A

NAMES

Team B

NAMES

Record the number of points achieved by each team within each half to a total of 15. Points are achieved when a player catches the Frisbee within the opponent's end zone.

First Half

Team A	Team B
TOTAL	

Second Half

Team A	Team B
TOTAL	

Note. The scorekeeper must sign the back of the score sheet when completed.

THIS PAGE INTENTIONALLY LEFT BLANK

VOLLEYBALL

OBJECTIVE

Teams attempt to score as many points as possible by hitting the ball into the opposing team's portion of the court. The team with the highest score at the end of the game is the winner. Volleyball helps improve the cardiovascular and muscular strength components of fitness.

SCORING

One point is awarded every time the ball hits inside the boundary lines of the opposing team's court; the opponents are unable to return the serve within three hits; the opponents hit the ball out of bounds; or the opponents commit a fault or foul when the team was the serving team.

DEFINITIONS

Attack hit. A hit aimed into the opponent's court.

Attack lines. These separate each side of the court into a front zone and a back zone.

Block. Occurs when one or more players stop the ball before, or just after, it crosses the net.

Rally. The exchange of hits back and forth between the teams. The team that wins the rally gets the serve.

Rotation order. Each team has a rotation order that must be kept when it gains the serve. Each time a team gains a serve; players will rotate one position clockwise.

NUMBER OF PLAYERS

Six players per team on the court at one time.

EQUIPMENT

- Volleyball,
- Volleyball net, and
- Volleyball court.

BASIC RULES

The game continues until a team scores 21 points in a rally format (a point is awarded on each play of the game regardless of which team serves the ball) and has a two-point advantage.

The team has three players on the front of the court and three on the back of the court.

Players can hit the ball with their hands clasped together or with either an open or closed fist. Players can strike the ball overhand or underhand.

One team will start the serving, the other receiving. A player retains the serve until the other team wins the right to serve.

Upon completing the serve a team must rotate positions.

The server may stand anywhere behind the end line to serve.

A service fault occurs if the ball touches a player of the serving team; fails to pass through the crossing space over the net; touches the net or any other object; or lands out of bounds.

If the team that is receiving stops their opponents from scoring, they are awarded the serve.

Each team has a maximum of three hits to get the ball over the net to return the ball. This is in addition to blocking.

Except on the serve, the ball is still in play if it touches the net.



Further details on the sport of volleyball can be found in *The Sports Rules Book: Essential Rules for 54 Sports* (1998), pp. 325–334.

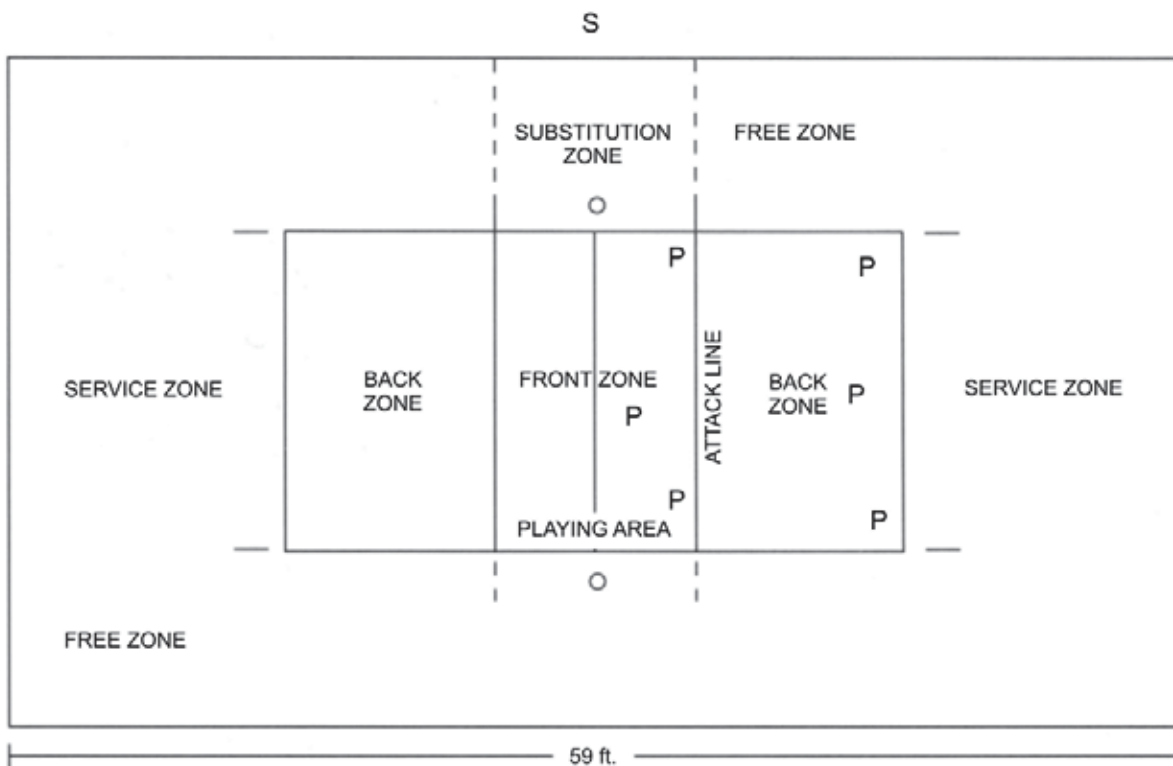

LEGEND

- P Player
- S Scorekeeper

Note. From The Sports Rules Book: Essential Rules for 54 Sports (p. 327), by T. Hanlon, 1998, USA: Human Kinetics Publishers, Inc. Copyright 1998 by Human Kinetics Publishers, Inc.

Figure AA-1 Volleyball Court

VOLLEYBALL SCORE SHEET

Team A

NAMES

Team B

NAMES

Check off each point as it is awarded to a team.

Points	1	2	3	4	5	6	7	8	9	10	11	12	13	14	15	16	17	18	19	20	21	
Team A																						
Team B																						

Note. The scorekeeper must sign the back of the score sheet when completed.

ACTIVE GAMES

INTRODUCTION

Active games are a great way of incorporating multiple components of fitness. These physical activities make fitness fun and can spark an interest in maintaining lifelong fitness. Active games help improve various components of fitness depending on the selected game.

EQUIPMENT

The equipment required for these games will depend on which game is selected.

ACTIVITY GUIDELINES

Active games shall be well supervised.

Active games shall be conducted in a large training area or playing field that is free of obstructions.

Cadets shall wear appropriate physical activity clothing and footwear for this activity.

SUGGESTED ACTIVE GAMES

Battleship

This is a nautical themed active game where the playing area is broken down into different parts of a ship, to include:

- **Bow.** The front of the playing area,
- **Stern.** The back of the playing area,
- **Port.** The left side of the playing area, and
- **Starboard.** The right side of the playing area.

There are special actions to be completed when called during the game, such as:

- **Submarines.** Cadets run to the centre of the playing area, lie down on their back, and raise one foot in the air.
- **Lifeboats Port.** Cadets run to the left side of the playing area, form a single line, sit down and begin to row.
- **Lifeboats Starboard.** Cadets run to the right side of the playing area, form single line, sit down and begin to row.

1. Begin the game with the cadets standing in the centre of the area.
2. Have the leader call one of the above parts of the ship or special action.
3. Have the cadets run to the designated area or perform the special action.
4. Eliminate the last cadet to reach the designated spot or perform the special action, and have them move to help the leader.
5. Continue until a winner is designated.

Cardio Blob Tag

A fast-paced game using two pool noodles where cadets must move or be swallowed by the “blob”.

1. Designate one cadet as the “blob”.
2. Have the “blob” carry a pool noodle to use to tag other cadets (below the shoulders).
3. Have the first tagged cadet join hands with the “blob” and give them the other pool noodle.
4. Ensure that the two cadets making the “blob” always remain joined (holding hands) and move throughout the group tagging other cadets.
5. Have any newly tagged cadets join the “blob” by holding hands with the cadet who tagged them and taking the pool noodle.
6. Allow the “blob” to grow until all the cadets have joined the “blob”.

Tag

There are many variations of tag games, such as cardio blob tag, everybody’s it, and frozen tag. These types of games begin with one or more cadets being designated as “it”. The “it” cadets must run and tag (touch) other cadets to either make them it, freeze them, or add them to the blob. There are many online resources and books for tag games. Select tag games that maximize movement and keep the cadets’ heart rates up.

SUGGESTED RESOURCES

Ultimate camp resource. (n.d.). *Camp games*. Retrieved October 6, 2011, from <http://www.ultimatecampresource.com/site/camp-activities/camp-games.html>

ISBN 0-934387-29-X Panicucci, J. (2008). *Achieving fitness: An adventure activity guide*. Beverly, MA: Project Adventure, Inc.

CIRCUIT TRAINING

INTRODUCTION

Circuit training was developed in the late 1950s at the University of Leeds in England. Circuit training consists of a number of carefully selected and simple-to-perform exercises in a set order called the "circuit". Each exercise is performed in turn, either a set number of times or within a set time period (usually 30–60 seconds), after a brief recovery period. A rotation through all stations is a circuit. The circuit is normally repeated three times.

Timed circuit training allows the activity to be conducted within a specific time limit. They also prevent waiting at exercise stations. They allow each individual to develop their fitness level at their own pace. Circuits that are not timed must be conducted using the maximum number of repetitions that can be done continuously without setting a specific time limit.

Circuit training may be adapted to focus on any component of fitness and may also be used to practice and improve various sports skills.

EQUIPMENT

Circuit training equipment, based on the stations selected.

ACTIVITY GUIDELINES

Circuits shall be designed based on activities and exercises that are appropriate for cadets. Many of the activities and exercises listed in this instructional guide may be used as stations in a circuit (eg, skipping rope and weighted bar exercises).

CIRCUIT DESIGN

When designing a circuit, the following should be considered:

- Exercises in a circuit may focus on cardiovascular endurance (eg, skipping rope), muscular strength (eg, medicine balls), muscular flexibility (eg, stretching), or a combination of them.
- Exercises must be arranged in an order so that no group of muscles is worked consecutively.
- Each station should have enough equipment for all cadets at that station to participate at once.
- When at a recovery station, the cadets must keep walking, jogging or moving around. They should also drink water.
- The number of activities chosen depends on the time allocated to complete the circuit.

Sample General Circuit Training

Each station will last 45 seconds.

<p>Station 1: Cardiovascular Endurance</p> <p>Exercise: Rope skipping Equipment: 6 skipping ropes</p>	<p>Station 2: Recovery</p> <p>Exercise: Jog on the spot Equipment: Nil.</p>	<p>Station 3: Muscular Strength</p> <p>Exercise: Curl-ups Equipment: Gym mats</p>
<p>Station 12: Recovery</p> <p>Exercise: Walk around the circuit Equipment: Nil.</p>	<p style="text-align: center;">INSTRUCTOR</p>	<p>Station 4: Recovery</p> <p>Exercise: Walk around the circuit Equipment: Nil.</p>
<p>Station 11: Muscular Strength</p> <p>Exercise: Squat thrusts Equipment: Nil.</p>		<p>Station 5: Muscular Flexibility</p> <p>Exercise: Spine twist stretch Equipment: 2 benches</p>
<p>Station 10: Recovery</p> <p>Exercise: Jog on the spot Equipment: Nil.</p>		<p>Station 6: Recovery</p> <p>Exercise: Jog on the spot Equipment: Nil.</p>
<p>Station 9: Muscular Flexibility</p> <p>Exercise: Knee to chest stretch Equipment: Gym mats</p>	<p>Station 8: Recovery</p> <p>Exercise: Walk around the circuit Equipment: Nil.</p>	<p>Station 7: Cardiovascular Endurance</p> <p>Exercise: Jumping jacks Equipment: Nil.</p>

SUGGESTED RESOURCES

ISBN 978-0-7360-8118-4 Carpenter, J. & Sinclair, C. Eds. (2011). *Physical best activity guide: Middle and high school levels*, 3rd edition. Windsor, ON: National Association for Sport and Physical Education.

MARTIAL ARTS

INTRODUCTION

Martial arts combine multiple components of fitness, including cardiovascular, muscular strength and muscular flexibility, into a fun, disciplined physical activity.

EQUIPMENT

The equipment required will depend on the selected type of martial arts.

ACTIVITY GUIDELINES

Martial arts shall be conducted by a certified instructor or using a video that is conducted by a certified instructor.

TYPES OF MARTIAL ARTS

Aikido. A Japanese form of self defense that uses wrist, joint and elbow grips to disable an opponent.

Kick Boxing. A martial art that resembles boxing but allows the use of the feet.

Judo. A method of defending oneself without the use of weapons. This method stresses the athletic component of this martial art.

Jiu-jitsu. A method developed in Japan for defending oneself using the strength and weight of an opponent to disable them.

SUGGESTED RESOURCES

Jeanette Jenkins, Certified by the Thai Boxing Association of Canada. *Crunch: Super-charged kickbox party.* 2007. [DVD]

ISBN 0-8048-3284-6 Westbrook, A. & Ratti, O. (1970). *Aikido and the dynamic sphere: An illustrated introduction.* North Clarendon, VT: Charle E. Tuddle Co., Inc.

THIS PAGE INTENTIONALLY LEFT BLANK

TABLOIDS

INTRODUCTION

Tabloid meets consist of various small, easy to play games or relay events. Tabloid meets are a fun way to be active and cover multiple components of fitness in one activity.

Tabloid meets have numerous advantages:

- a large number of personnel can participate at the same time;
- a wide variety of activities can be conducted;
- can be planned around existing facilities and equipment; and
- emphasis can be placed on team effort rather than on high-calibre performance by a small number of individuals.

Tabloid meets are intended for the cadets to work as a team, communicate, cooperate and have fun.

EQUIPMENT

The equipment required for tabloids will depend on which events are selected.

ACTIVITY GUIDELINES

The size of the group, the number of staff, the time allocated for the meet, the facilities and the equipment are factors that will affect the events, the group sizes, the time allocated at each event and the overall design of the meet. When designing a tabloid, ensure that the selected events are energetic and promote physical activity.

In a tabloid meet, the cadets must rotate through events in a pre-arranged fashion. A diagram of the stations can be displayed or signs with station numbers can be placed at each station.

Size of the Group

The size of the group will determine the number of events required. For example:

- If there are 60 cadets and the organizer wants them in teams of five, there should be at least 12 events (if there is only one team / event) or six events (if there are two teams / event).
- If there are 30 cadets and the organizer wants them in teams of three, there should be at least 10 events (if there is only one team / event) or five events (if there are two teams / event).

Number of Staff

The number of staff available to run the event may affect the number of events. Many personnel may be involved in a novelty events tabloid meet, such as:

- master scorekeeper,
- timekeeper,
- official for each event,
- first-aider, and / or
- runners (could be cadets from each team who bring the results to the master scorekeeper after each event).

Each event is controlled by one official who remains at the event throughout the meet. Their duty is to ensure safety and that the competitors observe the rules. After each event is completed, the official will fill out the scoresheet and send it to the master scorekeeper's table.

The master scorekeeper transfers the information from the team scoresheet to the master scoresheet.

Time Allocated For The Meet

Time allocated for the meet has to take into account the set-up, warm-up, cool-down, tear down, and award ceremony (if applicable).

Events should be planned so they take the same amount of time to be completed. This maintains control of the meet and ensures that all teams are at the same stage of the event.

Facilities

The facilities may offer a variety of events or put restrictions on them (eg, when using a school gym, it may be forbidden to bring food or particular items that could damage the floor).

Sample Tabloid Events

Examples of typical events are as follows:

Events	Description
Accuracy Throw	Each team member has to toss a beanbag or similar item into a ring of concentric circles with various point values. This continues until the time has elapsed.
Ball Over and Under	The team forms a single file line. The first person passes the ball over their head to the next person who then passes the ball between their legs to the next person. This continues to the last member who then runs to the front and starts again.
Basketball Throw	Each team member has to throw a basketball into the net from a specific point. This continues until the time has lapsed.
Skipping	Each team member has to skip with a jump rope as many times as they can without stopping.
Volleyball Bump	The team stands in a circle and a volleyball is bumped from person to person continuously without it touching the floor until the time has lapsed.

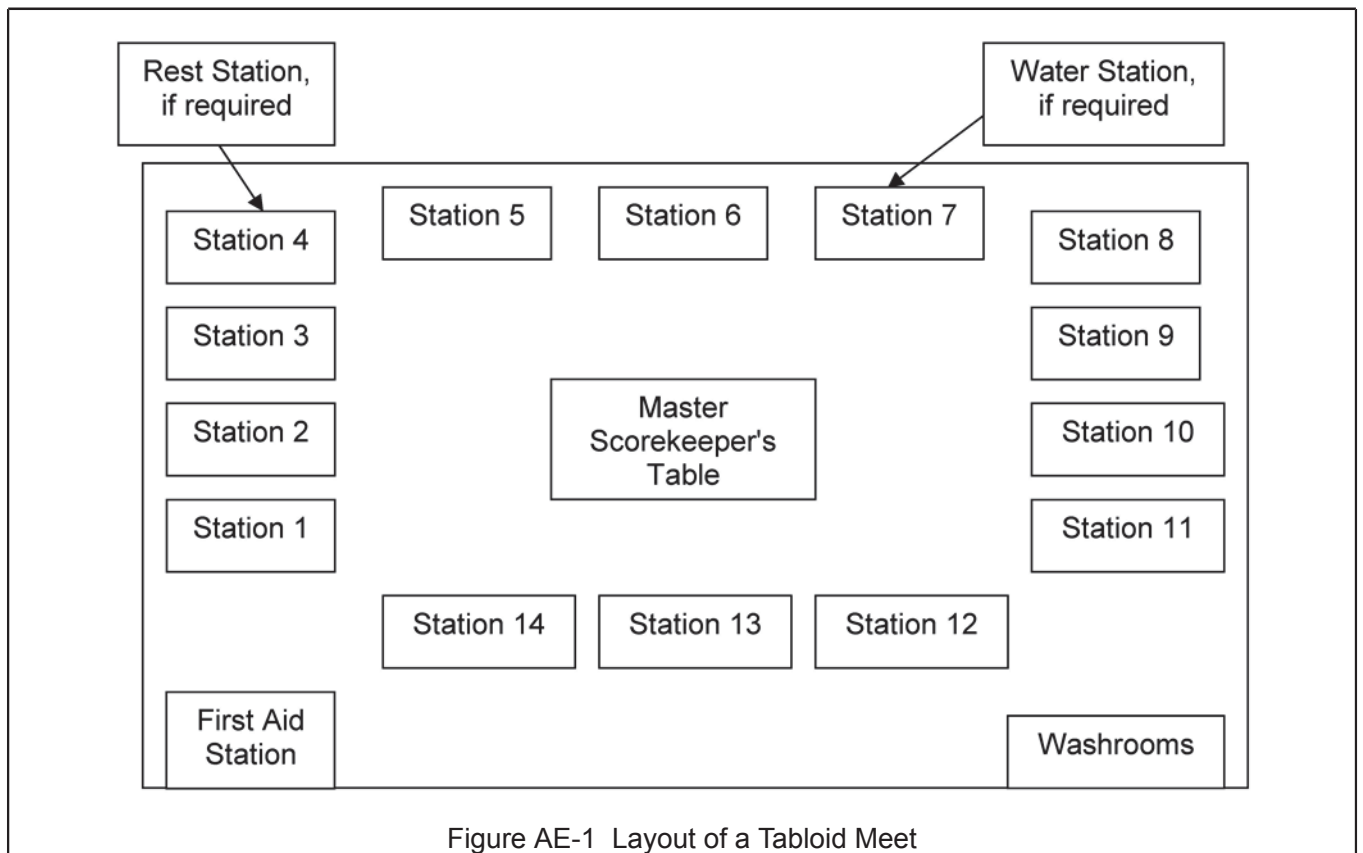

Figure AE-1 Layout of a Tabloid Meet

SUGGESTED RESOURCES

A-PD-050-015/PT-002 Directorate of Physical Education, Recreation and Amenities. (1989). *Physical fitness training in the Canadian Forces* (Vol. 2). Ottawa, ON: Department of National Defence.

The Canadian Association for Health, Physical Education, Recreation and Dance. (1983). *Basic skills series: Tabloid sports*. Calgary, AB: The Canadian Association for Health, Physical Education, Recreation and Dance.

THIS PAGE INTENTIONALLY LEFT BLANK



**COMMON TRAINING
ALL TRAINING LEVELS
INSTRUCTIONAL GUIDE
PHYSICAL ACTIVITIES**



SECTION 2

EO CX05.01 – PARTICIPATE IN PHYSICAL ACTIVITIES

Total Time:

9 x 30 min

THERE IS NO INSTRUCTIONAL GUIDE PROVIDED FOR THIS EO. REFER TO THE INSTRUCTIONAL GUIDE FOR EO MX05.01 (PARTICIPATE IN PHYSICAL ACTIVITIES).

THIS PAGE INTENTIONALLY LEFT BLANK



**COMMON TRAINING
ALL TRAINING LEVELS
INSTRUCTIONAL GUIDE
PHYSICAL ACTIVITIES**



SECTION 3

EO CX05.02 – PARTICIPATE IN A TOURNAMENT

Total Time:

9 x 30 min

PREPARATION

PRE-LESSON INSTRUCTIONS

This IG supports EO CX05.02 (Participate in a Tournament) located in A-CR-CCP-801/PG-001, *Proficiency Level One Qualification Standard and Plan*, Chapter 4.

Refer to EO MX05.01 (Participate in Physical Activities) for a list of sports to select from and rules associated with each.

Refer to the warm-up and the cool-down located at Annexes A and B of EO MX04.01 (Participate in 60 Minutes of Moderate- to Vigorous-Intensity Physical Activity and Track Participation in Physical Activities).

Select a tournament and refer to the following attachments for an overview of how to conduct the selected tournament:

- Attachment A–Round Robin,
- Attachment B–Ladder,
- Attachment C–Pyramid,
- Attachment D–Single Elimination, and
- Attachment E–Double Elimination.

PRE-LESSON ASSIGNMENT

Nil.

APPROACH

A practical activity was chosen for this lesson as it allows the cadets to participate in a tournament in a safe and controlled environment.

INTRODUCTION

REVIEW

Nil.

OBJECTIVES

By the end of this lesson the cadet shall have participated in a tournament.

IMPORTANCE

It is important for cadets to participate in a tournament because it is an activity that promotes camaraderie and a healthy lifestyle, while meeting the Cadet Program aim.

Teaching Point 1**Have the cadets participate in a tournament.**

Time: 9 x 30 min

Method: Practical Activity

BACKGROUND KNOWLEDGE

THE WARM-UP**Purpose of a Warm-Up**

A warm-up session is composed of light cardiovascular activities and stretches designed to:

- gradually increase respiratory action and heart rate;
- raise the muscle temperature to facilitate reactions in muscle tissue; and
- stretch the muscles.

This part of the warm-up prepares the cardiovascular system for the physical activity. It is composed of activities such as brisk walking, light jogging, or simple games that elevate the heart rate. As a guide, allow 10 minutes to warm up for every hour of physical activity.

THE COOL-DOWN**Purpose of a Cool-Down**

A cool-down is composed of light cardiovascular activities and stretches designed to:

- allow the body time to slowly recover from physical activity and to help prevent injury;
- prepare the respiratory system to return to its normal state; and
- stretch the muscles to help relax and restore them to their resting length.

Guidelines for Stretching

The following guidelines should be followed while stretching:

- Stretch all major muscle groups, including the back, chest, legs, and shoulders.
- Never bounce while stretching.
- Hold each stretch for 10–30 seconds to let the muscles release fully.
- Repeat each stretch two to three times.
- When holding a stretch, support the limb at the joint.

ACTIVITY

OBJECTIVE

The objective of this activity is to provide cadets the opportunity to participate in a tournament.

RESOURCES

- Sports / safety equipment required for the selected sport,
- First aid kit,

- Whistles,
- Stopwatch, and
- Schedule of competition.

ACTIVITY LAYOUT

Set up the training area for the selected sport.

ACTIVITY INSTRUCTIONS

1. Have the cadets participate in an introductory briefing, to include:
 - (a) an overview of the sport(s) that will be played during the tournament,
 - (b) type of tournament,
 - (c) rules of the tournament,
 - (d) organization of the draw, and
 - (e) location of first aid post.
2. Have the cadets participate in a warm-up session composed of light cardiovascular activities and stretches.
3. Have the cadets participate in the selected tournament.
4. Have the cadets participate in a cool-down session composed of light cardiovascular activities and stretches.

SAFETY

- Ensure cadets are aware of the rules and regulations.
- Ensure constant supervision throughout the activity.
- Ensure a first aid station / kit is readily accessible.
- Ensure a first-aider is identified at the start of the activity and is available at all times.

CONFIRMATION OF TEACHING POINT 1

The cadets' participation in the tournament will serve as the confirmation of this TP.

END OF LESSON CONFIRMATION

The cadets' participation in the tournament will serve as the confirmation of this lesson.

CONCLUSION

HOMEWORK / READING / PRACTICE

Nil.

METHOD OF EVALUATION

Nil.

CLOSING STATEMENT

Tournaments are fun activities that promote physical fitness, which is part of the aim of the Cadet Program. Participating in physical activities can help you:

- improve your health;
- do better in school;
- improve your fitness;
- grow stronger;
- have fun being active with friends;
- feel happier;
- maintain a healthy body weight;
- improve your self-confidence; and
- learn new skills.

INSTRUCTOR NOTES / REMARKS

Activities chosen for this training are not limited to the list presented but must be age appropriate.

Activities should be chosen based on equipment and facilities accessible to the corps / squadron.

REFERENCES

A0-050 A-PD-050-015/PT-002 Directorate of Physical Education, Recreation and Amenities. (1989). *Physical fitness training in the Canadian Forces* (Vol. 2). Ottawa, ON: Department of National Defence.

C0-187 San Diego County Office of Education. *After school physical activity: Types of tournaments*. Retrieved October 3, 2008, from <http://www.afterschoolpa.com/print/typesoftournaments.html>

THIS PAGE INTENTIONALLY LEFT BLANK

ROUND ROBIN TOURNAMENT

Recommended Use for a Round Robin Tournament

Round robin tournaments are best for league play or one-day tournaments that guarantee a certain number of games. All participants / teams play each other at least once. If there are a large number of participants / teams, a second, third or even fourth pool may be used.



Pool. A group of contestants who compete against each other in a tournament for the right to advance.

The number of courts or fields usually determines the number of pools. This is easy for participants / teams because they play all their games in the same location. The participants / teams may be used as referees, scorekeepers and linesmen during the round robin tournament.

The smaller the number of participants / teams in the pool, the shorter time it takes to complete the pool. Four to six participants / teams per pool are best.

To ensure fairness is shown to participants / teams, when making the pool, names should be chosen randomly (eg, pull the names out of a hat) and placed in the draw.

When using a round robin for a one-day tournament it may be combined with a single elimination tournament. The pool winners and runners-up may fill out a single elimination bracket. These participants / teams will play for the championship.

A tiebreaker system may be put in place before the start of the tournament (eg, points for versus points against).

Sample Draws

To arrange the rounds and the game schedule for an event for an even number of entries, keep the first entry constant and rotate the remaining as follows:

Round 1	Round 2	Round 3	Round 4	Round 5	Round 6	Round 7
1 - 8	1 - 2	1 - 3	1 - 4	1 - 5	1 - 6	1 - 7
2 - 7	3 - 8	4 - 2	5 - 3	6 - 4	7 - 5	8 - 6
3 - 6	4 - 7	5 - 8	6 - 2	7 - 3	8 - 4	2 - 5
4 - 5	5 - 6	6 - 7	7 - 8	8 - 2	2 - 3	3 - 4

Note. Created by Director Cadets 3, 2007, Ottawa, ON: Department of National Defence.

Figure A-1 Round Robin Draw With an Even Number of Participants



Bye. A term used when a participant / team moves into the next round of competition without participating in the previous round due to an uneven number of teams.

THIS PAGE INTENTIONALLY LEFT BLANK

LADDER TOURNAMENT

Recommended Use for a Ladder Tournament

The ladder tournament is the most popular form of extended tournaments (eg, racquet clubs, league play). It is best with pairs or individual participants such as racquet sports. Ladders may be created by ability grouping (eg, beginner, intermediate or advanced). Players / teams challenge the player / team above them on the ladder.

If the challenger wins, they exchange places on the ladder with the loser. If the challenger loses the competition, they stay where they are on the ladder.

Even though the tournament coordinator may modify the rules to suit the nature of the competition, possible rules for planning a ladder tournament are:

- Each contestant is permitted to challenge the player immediately above him / her, or up to two or three above.
- Provided the player challenged is not already involved in a previous challenge, he / she must accept the invitation within a given period.
- If the challenger wins, or the challenge is not accepted, the positions on the board are switched.

Challenges must be accepted and played within a certain time limit, usually one week. If a participant / team does not challenge within the time limit, they move down the ladder. Usually participants / teams are not allowed to challenge the same participant / team twice in a row.

Sample Draw

To ensure fairness is shown to participants / teams, when making the pool, names should be chosen randomly (eg, pull the names out of a hat).

If the number of entries to a ladder tournament is large, more than one ladder may be used. A player wishing to enter the competition late must challenge the player at the bottom of the lowest ladder.

Upon reaching the top of the ladder, a contestant may challenge the player at the bottom of the next higher ladder.

A winner of a ladder tournament may be declared on a set date, or the tournament may continue until the participants / teams decide that the tournament is over (eg, the participant / team at the top of the ladder cannot be beaten).

Byes

There are no byes in a ladder tournament.

A- DIVISION LADDER

K
B
A
D
E
C
J
F
H
G

B- DIVISION LADDER

c
d
b
a
f
j
e
h
k
g

(NEW ENTRY)

Note. Created by Director Cadets 3, 2007, Ottawa, ON: Department of National Defence.

Figure B-1 Ladder Draw

PYRAMID TOURNAMENT

Recommended Use for a Pyramid Tournament

The pyramid tournament is a popular form of an extended tournament (eg, racquet clubs, league play). A pyramid tournament is similar to a ladder tournament, but the board is in the form of a pyramid, with one participant / team at the top, two in the next row, three in the next, and so on. It is best with pairs or individual participants such as racquet sports. Players / teams challenge the player / team above them on the pyramid. A pyramid tournament gives participants / teams greater opportunity to challenge opponents because the step above them has more participants / teams listed.

If the challenger wins, they exchange places on the pyramid with the loser. If the challenger loses the competition, they stay where they are on the pyramid.

Challenges must be accepted and played within a certain time limit, usually one week. If a participant / team does not challenge within the time limit, they move down the pyramid. Usually participants / teams are not allowed to challenge the same participant / team twice in a row.

Sample Draw

To ensure fairness is shown to participants / teams, when making the pool, names should be chosen randomly (eg, pull the names out of a hat).

A winner of a pyramid tournament may be declared on a set date decided by the organizer, or the tournament may continue until the participants / teams decide that the tournament is over (eg, the participant / team at the top of the pyramid cannot be beaten).

Byes

There are no byes in a pyramid tournament.

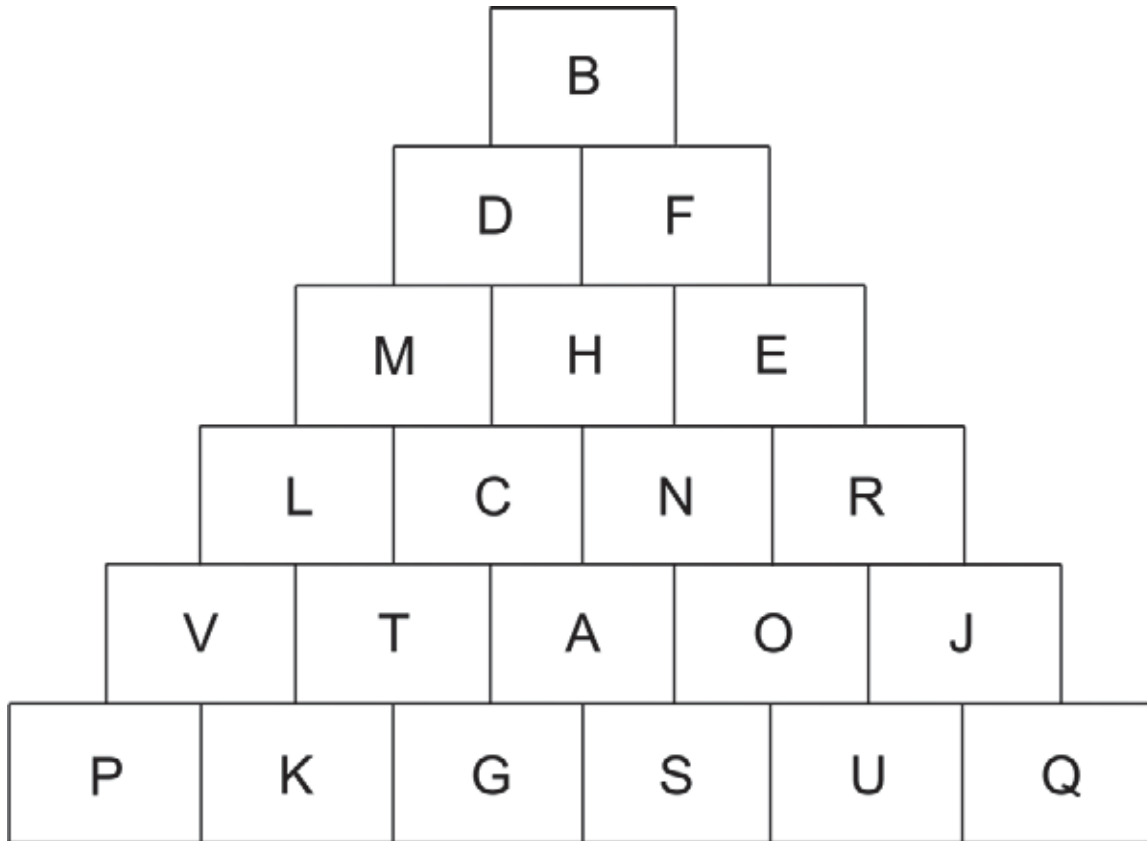

Note. Created by Director Cadets 3, 2007, Ottawa, ON: Department of National Defence.

Figure C-1 Pyramid Draw

SINGLE ELIMINATION TOURNAMENT

Recommended Use for a Single Elimination Tournament

The single elimination tournament is best used when there are a large number of entries, a short period of time and a limited number of courts / fields. It is the easiest of all tournaments to run. When participants / teams win, they continue to play. When participants / teams lose, they are eliminated from the tournament.

If there are a large number of participants / teams, multiple single elimination tournaments may be used. Participants / teams may be divided into skill levels (eg, beginner, intermediate and advanced) as three separate tournaments. This is a good format to use at the end of a round robin tournament with more than one pool, to determine an overall winner.

Sample Draws

To ensure fairness is shown to participants / teams, when making the pool, names should be chosen randomly (eg, pull the names out of a hat).

The maximum number of games to be played is equal to the number of entries minus one. If there are 12 players or teams, 11 games will be necessary to determine the winner.

The number of entries in Round 2 and subsequent rounds is always a power of 2 through the use of byes during Round 1.

Seeded Players

This term refers to outstanding players or teams who are placed in the draw in positions where they should, assuming they win all their matches, meet in the quarter or semifinals. The intent is to prevent the top competitors from meeting in the early rounds. There should be no more than 2 seeds to every 16 entries.

When seeded players are present (eg, when using a round robin combined with a single elimination tournament), the seeded players should be placed in the draw in positions where they should not meet before the quarters or semifinals.

Byes

A bye occurs in the single or double elimination competition when the number of entries is not a power of 2 (eg, 2, 4, 8, 16, 32).

When the number of entry is not a power of two, it is necessary to have a number of byes. All byes must be given in the first series so that the number of entries remaining in the subsequent series is always a power of 2.

When calculating the number of byes, the number of entries is subtracted from the next highest power of 2.

Number of participants / teams	Next highest power of 2	Calculation	Number of byes
2		Power of 2, so there are no byes.	
3	4	$4 - 3 = 1$	1
4		Power of 2, so there are no byes.	
5	8	$8 - 5 = 3$	3
6	8	$8 - 6 = 2$	2
7	8	$8 - 7 = 1$	1
8		Power of 2, so there are no byes.	
9	16	$16 - 9 = 7$	7
10	16	$16 - 10 = 6$	6
11	16	$16 - 11 = 5$	5
12	16	$16 - 12 = 4$	4
13	16	$16 - 13 = 3$	3
14	16	$16 - 14 = 2$	2
15	16	$16 - 15 = 1$	1
16		Power of 2, so there are no byes.	
17	32	$32 - 17 = 15$	15
18	32	$32 - 18 = 14$	14
19	32	$32 - 19 = 13$	13
20	32	$32 - 20 = 12$	12
21	32	$32 - 21 = 11$	11
22	32	$32 - 22 = 10$	10
23	32	$32 - 23 = 9$	9
24	32	$32 - 24 = 8$	8
25	32	$32 - 25 = 7$	7
26	32	$32 - 26 = 6$	6
27	32	$32 - 27 = 5$	5
28	32	$32 - 28 = 4$	4
29	32	$32 - 29 = 3$	3
30	32	$32 - 30 = 2$	2
31	32	$32 - 31 = 1$	1
32		Power of 2, so there are no byes.	

Note. Created by Director Cadets 3, 2008, Ottawa, ON: Department of National Defence.

Figure D-1 Byes Required in a Single or Double Elimination Tournament

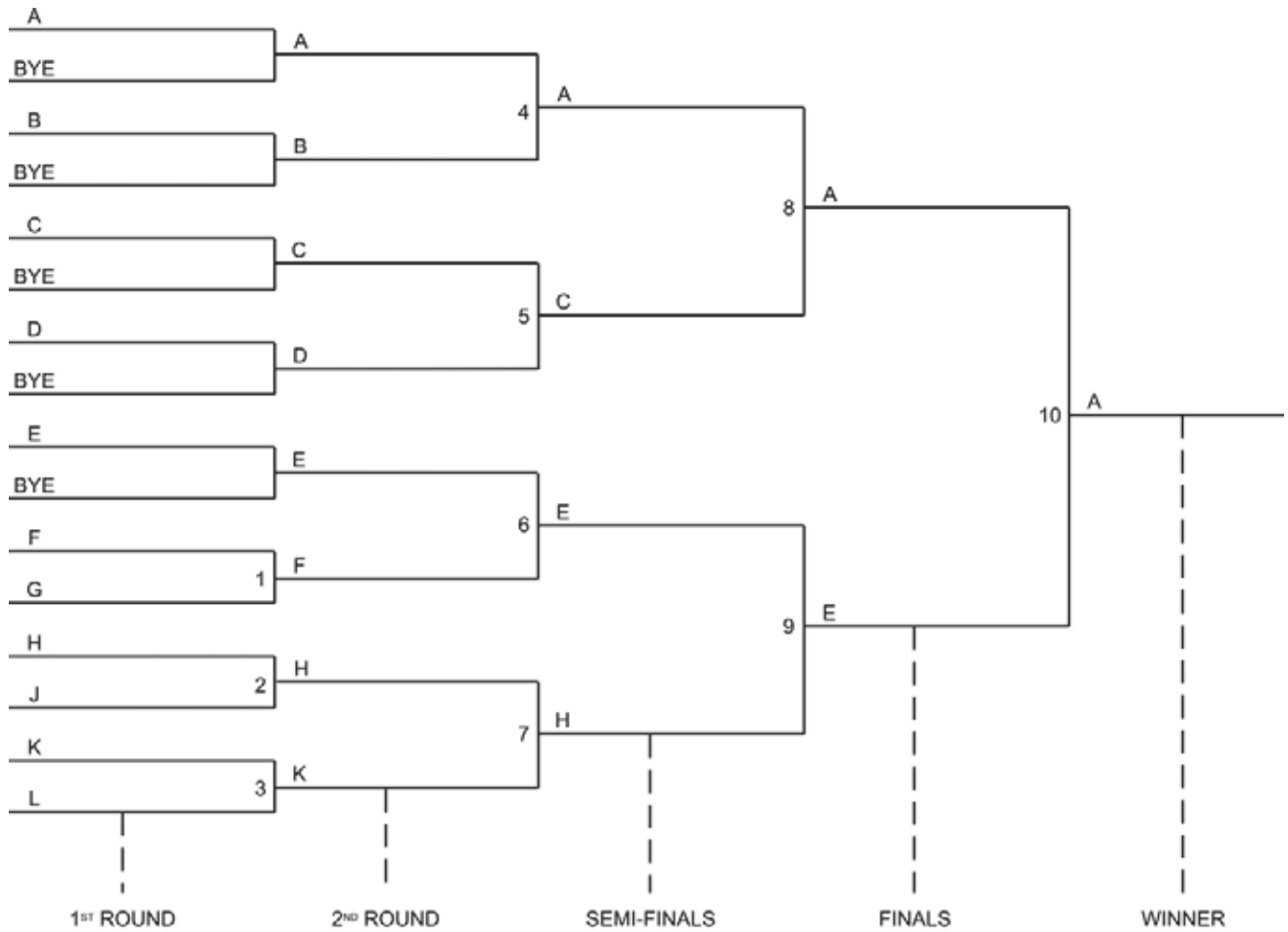

NOTES:

1. For eleven entries there are ten games (11-1) and five byes (16-11).
2. Letters denote advancing teams.
3. Numerals denote the order in which the games are played.

Note. From Physical Fitness Training in the Canadian Forces (Vol. 2) (p. 4-40) by Directorate of Physical Education, Recreation and Amenities, 1989, Ottawa, ON: Department of National Defence.

Figure D-2 Single Elimination Draw

THIS PAGE INTENTIONALLY LEFT BLANK

DOUBLE ELIMINATION TOURNAMENT

Recommended Use for a Double Elimination Tournament

This is very similar to the single elimination tournament with the major difference being that each participant / team must lose two games before being eliminated. This means that the tournament takes more time to conduct.

After their first loss, the participant / team is transferred to the left side of the bracket, where they are eliminated after the second defeat. In the finals, the winner of the left side (loser's bracket) meets the winner of the right side (winner's bracket). If the winner of the loser's bracket should defeat the winner of the winner's bracket, an additional game is required. After the completion of the second game, the participant / team that has suffered two defeats is eliminated and the other participant / team is declared the winner.

Sample Draws

The maximum number of games to be played is equal to double the number of entries minus one. If there are 12 teams or participants, 23 games would be the maximum number of games to be played ($12 \times 2 - 1 = 24 - 1 = 23$).

A double elimination tournament is not advisable when more than 10 teams are part of the event. The winner on the loser's side would be involved in too many games before the championship can be decided.

Seeded Players

If seeded players are competing, they should be placed in each section of the draw so that they may be expected to reach quarter or semifinals without meeting a seeded player. The remaining positions can be drawn randomly out of a hat.

Byes

If the number of entries is not a perfect power of 2, byes will be required.

All byes must be given in the first series so that the number of entries remaining in the subsequent series is always a power of 2. The byes should be divided evenly between the top and bottom halves.

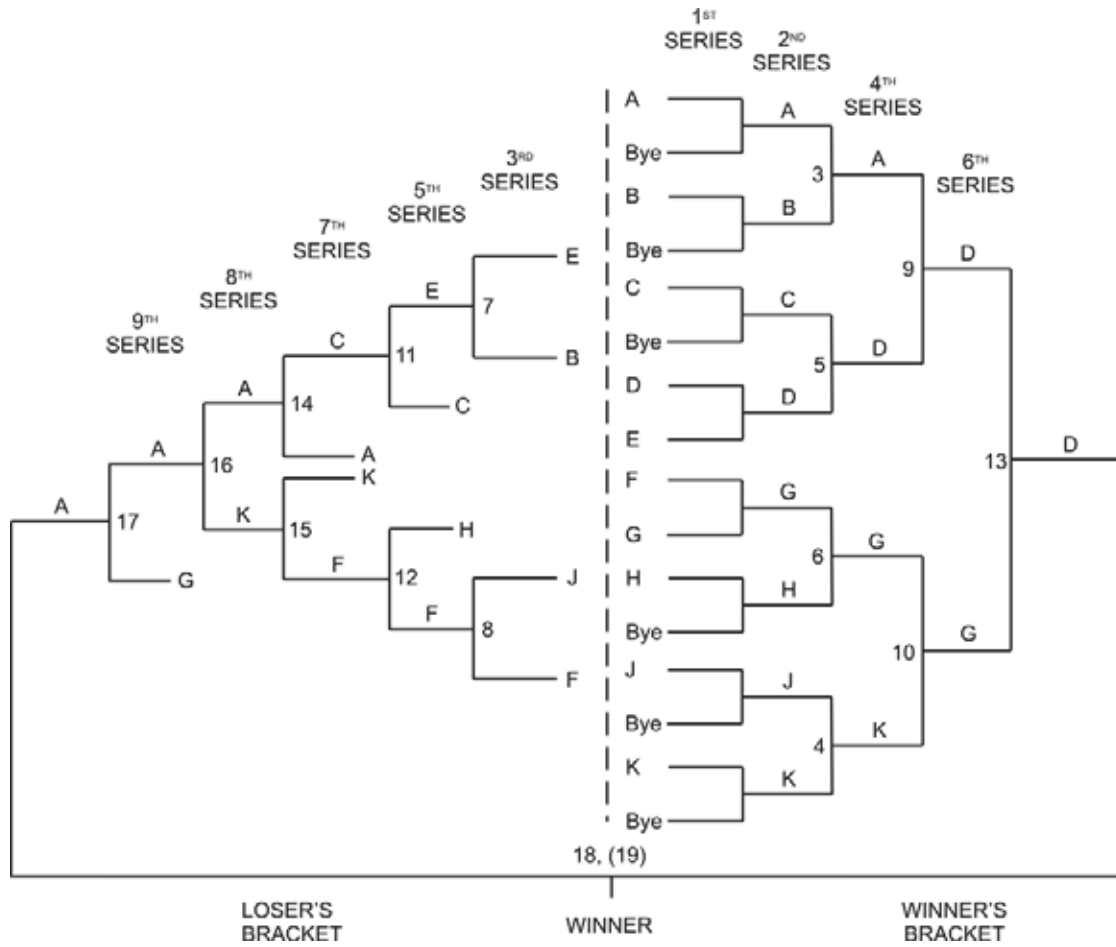

Note. From *Physical Fitness Training in the Canadian Forces (Vol. 2)* (p. 4-40) by Directorate of Physical Education, Recreation and Amenities, 1989, Ottawa, ON: Department of National Defence.

Figure E-1 Double Elimination Draw