



**ROYAL CANADIAN AIR CADETS
PROFICIENCY LEVEL FOUR
INSTRUCTIONAL GUIDE**



SECTION 1

EO M490.01 – ASSEMBLE AN EMERGENCY SURVIVAL KIT

Total Time: 30 min

PREPARATION

PRE-LESSON INSTRUCTIONS

Resources needed for the delivery of this lesson are listed in the lesson specification located in A-CR-CCP-804/PG-001, *Proficiency Level Four Standard and Plan*, Chapter 4. Specific uses for said resources are identified throughout the instructional guide within the TP for which they are required.

Review the lesson content and become familiar with the material prior to delivering the lesson.

Gather the emergency kit items needed for TP 3.

PRE-LESSON ASSIGNMENT

Nil.

APPROACH

An interactive lecture was chosen for TPs 1 and 2 to present basic material and give direction on assembling an emergency survival kit.

An in-class activity was chosen for TP 3 as it is an interactive way to provoke thought and stimulate interest among cadets about emergency survival kits.

INTRODUCTION

REVIEW

Nil.

OBJECTIVES

By the end of this lesson the cadets shall have assembled an emergency survival kit.

IMPORTANCE

It is important for cadets to be prepared for survival situations. Carrying an emergency survival kit at all times while in the field and knowing the purpose of the contents may help the cadets to react appropriately to survival situations.

Teaching Point 1**Discuss the characteristics of an emergency survival kit.**

Time: 5 min

Method: Interactive Lecture

ESSENTIAL ITEMS

The items carried in a personal emergency survival kit must meet the needs of a person in a survival situation. The essential items to fulfill these needs can be categorized.

Personal protection. This includes clothing, shelter, and fire.

Signalling. Constructed signals are ground-to-air signals and signal fires. An improvised signal may be a piece of shiny metal used as a signal mirror.

Sustenance. Water and food.

Travel. Navigating with and without a compass.

Health. This includes trauma and environmental injuries as well as mental health, which affects the will to survive.

SMALL AND EASY TO CARRY IN A POCKET

If the emergency survival kit is not with the person when it is needed, it is worthless. It needs to be carried at all times during outdoor activities.

It should be small enough to fit into a pocket, but not so bulky as to restrict movement.

It should be easy and comfortable to carry so that once placed in the pocket, it stays there until the outdoor activities are over or it is needed.

CONFIRMATION OF TEACHING POINT 1**QUESTIONS:**

- Q1. Name the five categories that should be considered when choosing essential items for an emergency survival kit.
- Q2. When should you carry an emergency survival kit?
- Q3. Where should an emergency survival kit be located?

ANTICIPATED ANSWERS:

- A1. Personal protection, signalling, sustenance, travel, and health.
- A2. At all times during outdoor activities.
- A3. It should be in your pocket.

Teaching Point 2**Explain that emergency survival kit items should be placed in a durable container that is lightweight and waterproof.**

Time: 5 min

Method: Interactive Lecture

The items in an emergency survival kit need to be readily available and in a useable condition, neither damaged by water nor compression (squished).

DURABLE

A container for an emergency survival kit must be durable to prevent compression, which can damage the items within.

LIGHTWEIGHT

The container should be lightweight. If it is too heavy, it becomes a burden to carry and therefore may be packed in the rucksack / backpack and not with the person when needed.

WATERPROOF

The container should be waterproof to protect items from water damage. Damaged items may be of no help in a survival situation.

Different types of containers have different characteristics which should be taken into account before deciding on which type a person will use. Types of containers include:

- **Hard plastic.** Very durable but may be uncomfortable to carry in a pocket.
- **Flexible plastic.** Durable, more comfortable than hard plastic in a pocket.
- **Metal.** Very durable but may be uncomfortable to carry in a pocket. However, unlike the plastic containers, a metal container may be used over a fire for multiple uses (eg, cooking, purifying water).

CONFIRMATION OF TEACHING POINT 2**QUESTIONS:**

- Q1. What three features should an emergency survival kit container have?
- Q2. What are the differences between containers made from hard and flexible plastic?
- Q3. What may be done with a metal container but not a plastic one?

ANTICIPATED ANSWERS:

- A1. It should be durable (to prevent compression), lightweight and waterproof (to protect items from water damage).
- A2. The hard plastic container is more durable, but the flexible plastic container will be more comfortable to carry in a pocket.
- A3. It may be used over a fire.

Teaching Point 5

Explain the purpose of each emergency survival kit item and have the cadets, as a group, assemble an emergency survival kit.

Time: 15 min

Method: In-Class Activity

BACKGROUND KNOWLEDGE**THE PURPOSE OF EACH EMERGENCY SURVIVAL KIT ITEM**

Adhesive bandages. Used for minor first aid.

Aluminum foil. May be used for cooking, water collection, and signalling.

Antibiotic tablets. Used to reduce the health risk of injuries.

Button compass. Used to determine direction.

Candle. May be used as a light source and a fire starter.

Condom. Used for water storage.

Cord. Used for lashings in multiple applications.

Cotton balls. May be used as tinder and to perform minor first aid.

Emergency blanket. Used to keep warm and may also be used for signalling.

Fish hooks. Used to catch fish.

Fishing line. Used to catch fish, but may also be used for lashings.

Fishing sinkers. Used to catch fish.

Flexible saw. Used to cut wood.

Garbage bag (small). This item has multiple uses: for raingear, as a water collector and for food storage.

Hard candies. Used as an energy food. It is also a morale booster.

Magnifying glass. Used to light fires and for first aid (to find small splinters).

Mirror (small). Used for signalling.

Moleskin. This item may be used as minor first aid for blisters.

Pain reliever (pills). Acetylsalicylic acid or acetaminophen, used as a pain reliever.

Paper. Used to write notes and may be used as tinder.

Pencil. Used to write notes.

Personal medication. Used to maintain health.

Re-sealable plastic bags (very small). Used to waterproof and organize small items within the kit.

Safety pins. These have multiple uses: to perform minor first aid and to repair clothing and equipment.

Salt. Used to maintain health.

Sewing needles. This item may be used for minor first aid and to repair clothing and equipment.

Small folding knife. Most versatile item in the survival kit.

Snare wire. Used to catch small animals and may also be used for lashings.

Thread. This item has multiple uses: used to create small lashings, for minor first aid and to repair clothing and equipment.

Tweezers. Used for minor first aid and to untie knots (so cord may be reused).

Water purification tablets. Used to purify water.

Waterproof matches. Used to light fires.

Whistle. Used to signal for help and to help scare off animals.

ACTIVITY

Time: 15 min

OBJECTIVE

The objective of this activity is to have the cadets assemble an emergency survival kit.

RESOURCES



This is not an exhaustive list and is designed to give cadets an idea of what an emergency survival kit could contain.

- hard or flexible plastic or metal container,
- adhesive bandages,
- aluminum foil,
- antibiotic tablets,
- button compass,
- candle,
- condom,
- cord,
- cotton balls,
- emergency blanket,
- fish hooks,
- fishing line,
- fishing sinkers,
- flexible saw,
- garbage bag (small),
- hard candies,
- magnifying glass,
- mirror (small),
- moleskin,
- pain reliever (pills),

- paper,
- pencil,
- personal medication,
- resealable plastic bags (very small),
- safety pins,
- salt,
- sewing needles,
- small folding knife,
- snare wire,
- thread,
- tweezers,
- water purification tablets,
- waterproof matches, and
- whistle.

ACTIVITY LAYOUT

Nil.

ACTIVITY INSTRUCTIONS

1. Show the cadets the hard or flexible plastic or metal container to be used for the emergency survival kit.
2. Ask the cadets what items should be in an emergency survival kit.
3. As each item is suggested, list it on the whiteboard / flip chart.
4. If the item suggested has been brought as an example, show it to the cadets.
5. Describe the purpose of the item.
6. Pass the item to a cadet.
7. Have the cadet place the item into the hard or flexible plastic or metal container to create an emergency survival kit.
8. Repeat Steps 3–7.



Ensure the items that are listed but not brought as examples are explained to the cadets.

SAFETY

Nil.

CONFIRMATION OF TEACHING POINT 3

The cadets' participation in the activity and the assembly of an emergency survival kit will serve as the confirmation of this TP.

END OF LESSON CONFIRMATION

The cadets' assembly of an emergency survival kit will serve as the confirmation of this lesson.

CONCLUSION

HOMEWORK / READING / PRACTICE

This EO is assessed IAW A-CR-CCP-804/PG-001, *Proficiency Level Four Standard and Plan*, Chapter 3, Annex B, 490 PC.

METHOD OF EVALUATION

Nil.

CLOSING STATEMENT

Being in possession of an emergency survival kit will greatly enhance your capabilities in a survival situation.

INSTRUCTOR NOTES / REMARKS

Cadets who are qualified Survival Instructor may assist with this instruction.

REFERENCES

C2-010 ISBN 0-375-70323-3 Rawlins, C., & Fletcher, C. (2004). *The complete walker IV*. New York, NY: Alfred A. Knopf.

C3-002 ISBN 0-00-653140-7 Wiseman, J. (1999). *SAS survival handbook*. Hammersmith, London: HarperCollins Publishers.

C3-003 ISBN 1-896713-00-9 Tawrell, P. (1996). *Camping and wilderness survival: The ultimate outdoors book*. Green Valley, ON: Author.

C3-150 ISBN 978-0-8117-3292-5 Davenport, G. (2002). *Wilderness survival*. Mechanicsburg, PA: Stackpole Books.

THIS PAGE INTENTIONALLY LEFT BLANK



ROYAL CANADIAN AIR CADETS
PROFICIENCY LEVEL FOUR
INSTRUCTIONAL GUIDE



SECTION 2

EO M490.02 – OPERATE A STOVE AND A LANTERN

Total Time: 90 min

PREPARATION

PRE-LESSON INSTRUCTIONS

Resources needed for the delivery of this lesson are listed in the lesson specification located in A-CR-CCP-804/PG-001, *Proficiency Level Four Qualification Standard Plan*, Chapter 4. Specific uses for said resources are identified throughout the instructional guide within the TP for which they are required.

Review the lesson content and become familiar with the material prior to delivering the lesson.

The lesson has been designed using the common features of naphtha fuelled two-burner stoves and dual-mantle lanterns. Consult the operating manuals of the equipment to be used, and if necessary, modify the TPs accordingly.

PRE-LESSON ASSIGNMENT

Nil.

APPROACH

An interactive lecture was chosen for TPs 1 and 2 to introduce to the cadets the characteristics of the stove and of the lantern.

A demonstration and performance was chosen for TPs 3–6 as it allows the instructor to explain and demonstrate how to operate a stove and lantern while providing an opportunity for the cadets to practice the skill under supervision.

INTRODUCTION

REVIEW

Nil.

OBJECTIVES

By the end of this lesson the cadet shall have operated and a stove and a lantern.

IMPORTANCE

It is important for cadets to safely operate and maintain the stoves and lanterns most commonly used during field training. While on field training, a base of operations is required to support survival training.

Teaching Point 1

Identify the characteristics of a two-burner naphtha stove.

Time: 10 min

Method: Interactive Lecture

CHARACTERISTICS

The following are characteristics of a two-burner naphtha stove:

- It is capable of operating with a clean, smokeless flame.
- The flame can be quickly extinguished.
- It is easily ignited in cold weather.
- It is easy to refuel.
- It has no noxious odours.
- Fuel in the tank will not spill when being carried in any position.
- It cools quickly.
- It is easily cleaned and repaired.

Operational Temperature

A two-burner stove (that uses naphtha as a fuel), when shielded from the wind, can be used in temperatures as low as -52 Celsius.

Fuel Type

The stove uses naphtha. (Note: also known as white gas, camping fuel and Coleman fuel.)

Parts and Accessories



The following diagram is provided for part identification, not disassembly purposes.

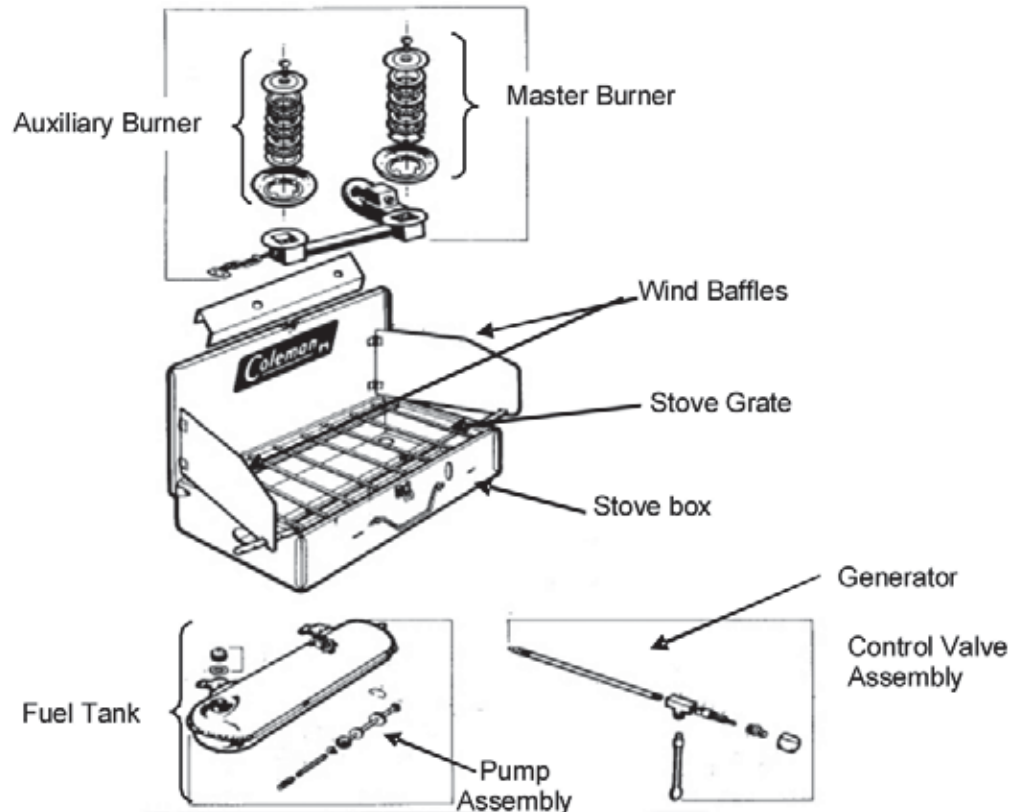

Figure 1 Parts of the Coleman Two-Burner Stove

Note. From Basic Cold Weather Training, Arctic and Sub Arctic Operations (Vol. 2) (p.2-75), 1982, Ottawa, ON: Department of National Defence. Copyright 1982 by Department of National Defence.

Stove box. This is the container in which the burners are mounted. The fuel tank and generator assembly are also stored here when the stove is disassembled for storage.

Control valve assembly. This consists of the main valve wheel, auxiliary value, nut and body. Its function is to regulate the flow of pressurized fuel from the fuel tank through the generator to the burner head. It remains attached to the fuel tank.

Master Burner. The master burner head is located on the right (or left, depending on make / model) of the stove and consists of a burner cap and a small screw with a series of burner rings. The entire assembly sits in a large burner bowl. The master burner control knob is located on the valve and generator assembly.

Auxiliary burner. The auxiliary burner head is located on the left (or right, depending on make / model) of the stove and consists of a burner cap and small screw along with a series of small burner rings. The entire assembly sits in a small burner bowl. The auxiliary burner control valve is located on the left (right) side of the stove box.

Pump assembly. The pump assembly is fitted into the tank and is held in place by a pump cap clip.

Fuel tank. The fuel tank is red in colour. The tank fits on the front of the stove box when in use.

Wind baffles. The wind baffles shelter the burners from the wind.

Stove grate. The stove grate supports cookware.

Generator. The generator supplies fuel to the burners. Fuel passing through the generator is heated by the master burner.

Precautions

Hazards are few if precautions are taken. Follow these simple rules:

- Never leave a lit stove unattended.
- Do not use a stove as a heating device or in an enclosed space.
- Never remove the fuel tank or loosen the filler cap on the fuel tank while the stove is in operation.
- Always fill and light the stove outside in a well ventilated area, away from open flame, heat and combustibles.
- Use only naphtha fuel.
- Store away from open flame or excessive heat.
- Always ensure wind baffles and lid supports are securely positioned before lighting the stove.
- Before transporting or storing, ensure the stove is cool. Loosen the filler cap to release the air pressure and retighten. Turn the control knob off. Ensure pump valve is closed.
- If the stove catches fire, turn off the fuel supply, close the wind baffles and drop the stove lid.
- When removing the fuel tank to be refilled, remember that the generator gets HOT when the stove is operated. Allow the generator to cool before refilling the fuel tank.
- When using the stove ensure that a fire extinguisher is readily available.



It is important to stress to cadets that stoves and lanterns should not be used in enclosed spaces such as buildings and tents unless they are well ventilated. The burning of naphtha results in the release of carbon monoxide. Carbon monoxide is heavier than air, it therefore pools in the bottoms of buildings and tents, where cadets usually sleep. It will not dissipate, even for days, unless it is forced out by a strong, persistent, direct draft of cold air at floor / ground level. Carbon monoxide can kill.

CONFIRMATION OF TEACHING POINT 1

QUESTIONS:

- Q1. What type of fuel is used?
- Q2. What is the purpose of the generator?
- Q3. Why should you only operate a stove in a well ventilated place?

ANTICIPATED ANSWERS:

- A1. Naphtha. (Note: also known as white gas, camping fuel and Coleman fuel.)
- A2. The generator supplies fuel to the burners. Fuel passing through the generator is heated by the master burner.

- A3. The burning of naphtha results in the release of carbon monoxide. Carbon monoxide is heavier than air, it therefore pools in the bottoms of buildings and tents, where cadets usually sleep. It will not dissipate, even for days, unless it is forced out by a strong, persistent, direct draft of cold air at floor / ground level. Carbon monoxide can kill.

Teaching Point 2

Identify the characteristics of a dual-mantle naphtha lantern.

Time: 5 min

Method: Interactive Lecture

CHARACTERISTICS

Dual-mantle lanterns are designed to burn naphtha. This fuel is pressurized in a tank attached to the unit, heated in a generator and then burned as a gas.



A lit lantern produces heat. Flammable materials should be kept a minimum of 60 cm above and 30 cm from all sides of the lantern.

Parts and Accessories

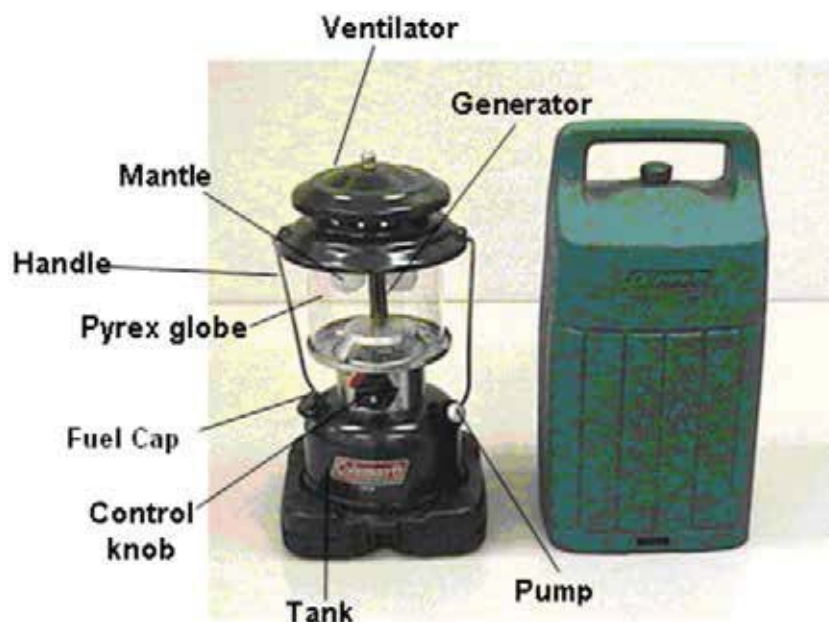

Figure 2 Coleman Dual-Mantle Lantern

Note. Created by Director Cadets 3, 2007, Ottawa, ON: Department of National Defence.

Ventilator. Allows for heat and exhaust to evacuate the lantern.

Generator. Provides pressurized fuel to the mantle.

Mantle. Emits a bright light by the burning naphtha fuel.

Handle. Allows the user to carry or hang the lantern.

Pyrex globe. Protects the mantle from foreign debris. The globe also reduces the amount of oxygen entering the lantern.

Fuel cap. Seals the fuel tank.

Control knob. Controls the amount of fuel entering the generator, controlling the brightness of the lantern.

Tank. Is a fuel storage reservoir.

Pump. Pumps air into the fuel tank, pressurizing the tank.

Precautions

Hazards are few when precautions are taken. The following simple rules should be used:

- Never leave a lit lantern unattended.
- Do not use a lantern as a heating device or in an enclosed space.
- Never loosen the filler cap on the fuel tank while the lantern is in operation.
- Always fill and light the lantern outside in a well ventilated area, away from open flame, heat and combustibles.
- Use only naphtha fuel.
- Store away from open flame or excessive heat.
- If the lantern catches fire, turn off the fuel supply and let the excess fuel burn off.
- When using the lantern ensure that a fire extinguisher is readily available.
- The ventilator is HOT when lantern is lit.
- If hung by the handle while the lantern is lit, the handle is HOT.
- Mantles should be regularly checked for holes (replace if found).

CONFIRMATION OF TEACHING POINT 2

QUESTIONS:

- Q1. What does the mantle do?
- Q2. What does the pump on the lantern do?
- Q3. When a lit lantern is hung, what should you keep in mind about the handle?

ANTICIPATED ANSWERS:

- A1. It emits a bright light by the burning naphtha fuel.
- A2. It pumps air into the fuel tank, pressurizing the tank.
- A3. If hung by the handle while the lantern is lit, the handle is HOT.

Teaching Point 3**Explain, demonstrate and have the cadets fill and drain a stove and a lantern, utilizing a drip pan.**

Time: 15 min

Method: Demonstration and Performance

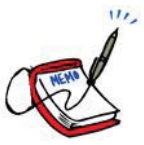

For this skill, it is recommended that instruction take the following format:

1. Explain and demonstrate the complete skill while cadets observe.
2. Explain and demonstrate each step required to complete the skill. Monitor cadets as they imitate each step.
3. Monitor the cadets' performance as they practice the complete skill.

Note: Assistant instructors may be employed to monitor the cadets' performance.



Stoves and lanterns must be cool to the touch before filling or draining.

Filling a Stove

The steps to fill a two-burner stove tank are as follows:

1. Ensure main valve wheel is closed.
2. Close pump knob firmly.
3. Remove fuel cap.
4. Insert funnel.
5. Ensure fuel tank is level.
6. Fill with clean, fresh fuel until the level reaches the bottom of the fill hole.
7. Remove funnel, ensuring any spills / overflow fall into the drip pan.
8. Replace fuel cap.

Filling a Lantern

The steps to fill a dual-mantle lantern are as follows:

1. Ensure control valve is closed.
2. Close pump knob firmly.
3. Remove fuel cap.
4. Insert funnel.
5. Ensure lantern is level.
6. Fill with clean, fresh fuel until the level reaches the bottom of the fill hole.

7. Remove funnel, ensuring any spills / overflow fall into the drip pan.
8. Replace fuel cap.

Draining a Stove

The steps to drain a two-burner stove tank are as follows:

1. Ensure main valve wheel is closed.
2. Close pump knob firmly.
3. Remove fuel cap.
4. Insert funnel into fuel storage container.
5. Slowly and carefully pour fuel from tank into the funnel, ensuring any spills / overflow fall into the drip pan.
6. Replace fuel cap.

Draining a Lantern

The steps to drain a dual-mantle lantern are as follows:

1. Ensure control valve is closed.
2. Close pump knob firmly.
3. Remove fuel cap.
4. Insert funnel into fuel storage container.
5. Slowly and carefully pour fuel from lantern into the funnel, ensuring any spills / overflow fall into the drip pan.
6. Replace fuel cap.

CONFIRMATION OF TEACHING POINT 3

The cadets' participation in filling and draining a stove and a lantern will serve as the confirmation of this TP.

Teaching Point 4

Explain, demonstrate and have the cadets operate a two-burner naphtha stove.

Time: 15 min

Method: Demonstration and Performance



For this skill, it is recommended that instruction take the following format:

1. Explain and demonstrate the complete skill while cadets observe.
2. Explain and demonstrate each step required to complete the skill. Monitor cadets as they imitate each step.
3. Monitor the cadets' performance as they practice the complete skill.

Note: Assistant instructors may be employed to monitor the cadets' performance.

ASSEMBLING

To assemble a two-burner stove:

1. Unlatch and open the stove (as per Figure 3).
2. Open and secure the wind baffles (as per Figure 4).
3. Lift the grate and remove the fuel tank (as per Figure 5).
4. Install the fuel tank. Ensure the generator passes through the large hole in the front of the stove and is inserted into the opening in the mixing chamber above the burner. Insert hanger brackets on the tank into the slots located on the front of the stove case (as per Figure 5).
5. Secure the safety chain (as per Figure 6).
6. Close the grate (as per Figure 7).
7. Ensure the auxiliary burner valve is in the closed position (as per Figure 8).



Figure 3 Closed Stove

Note. Created by Director Cadets 3, 2007, Ottawa, ON: Department of National Defence.



Figure 4 Wind Baffles

Note. Created by Director Cadets 3, 2007, Ottawa, ON: Department of National Defence.



Figure 5 Installing the Fuel Tank

Note. Created by Director Cadets 3, 2007, Ottawa, ON: Department of National Defence.



Figure 6 Securing the Safety Chain

Note. Created by Director Cadets 3, 2007, Ottawa, ON: Department of National Defence.



Figure 7 Closed Gate

Note. Created by Director Cadets 3, 2007, Ottawa, ON: Department of National Defence.



Figure 8 Auxiliary Burner Control

Note. Created by Director Cadets 3, 2007, Ottawa, ON: Department of National Defence.

LIGHTING AND EXTINGUISHING



The stove fuel tank should have been fuelled previous to this lesson; however, it should not be pressurized.

Pressurizing the Fuel Tank

1. Make sure the control knob is in the OFF position.
2. Turn the pump rod two full turns counter-clock wise (as per Figure 9).
3. Place the thumb over the air vent of the pump rod handle (as per Figure 9).
4. Pump 30–40 full strokes to pressurize the fuel tank.
5. Turn the pump rod clockwise until it is closed tight (as per Figure 9).

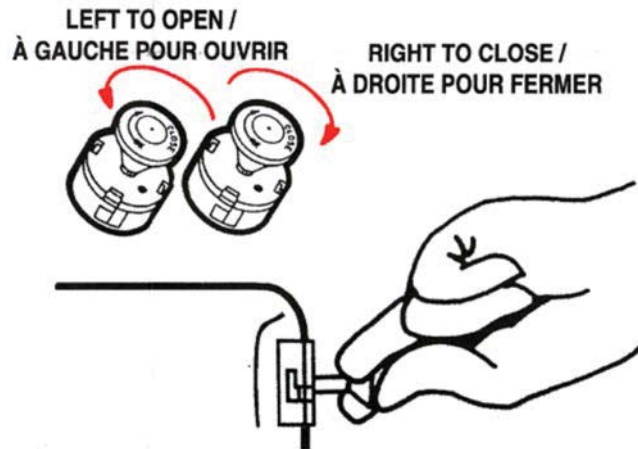

Figure 9 Pressurizing the Fuel Tank

Note. From *Coleman Camp Stove Model M425F710C Instructions for use*, by The Canadian Coleman Co., Mississauga, ON: The Coleman Company, Inc.

Lighting the Master Burner



During colder conditions, it may be necessary to warm the generator prior to lighting. This can be accomplished by applying a small amount of fuel to the master burner directly and lighting it with a match. The burning fuel will heat the generator, heating the fuel inside and facilitating the lighting of the burner. When the generator is not adequately heated it is possible for liquid fuel to pool in the stove which is very dangerous.

1. Ensure the auxiliary valve is in the closed position and the tank is pumped.
2. Do not lean over the stove while lighting.
3. Hold a lit match near the master burner (as per Figure 10).
4. Turn the instant light lever to the UP TO LIGHT position (as per Figure 10).
5. Turn the main valve control knob to the LIGHT position or setting.
6. Monitor the flame.
7. When the flame turns blue in colour (approximately one minute), turn the instant light lever to the DOWN TO BURN position and turn the control knob to the desired heat setting (HI – LO).

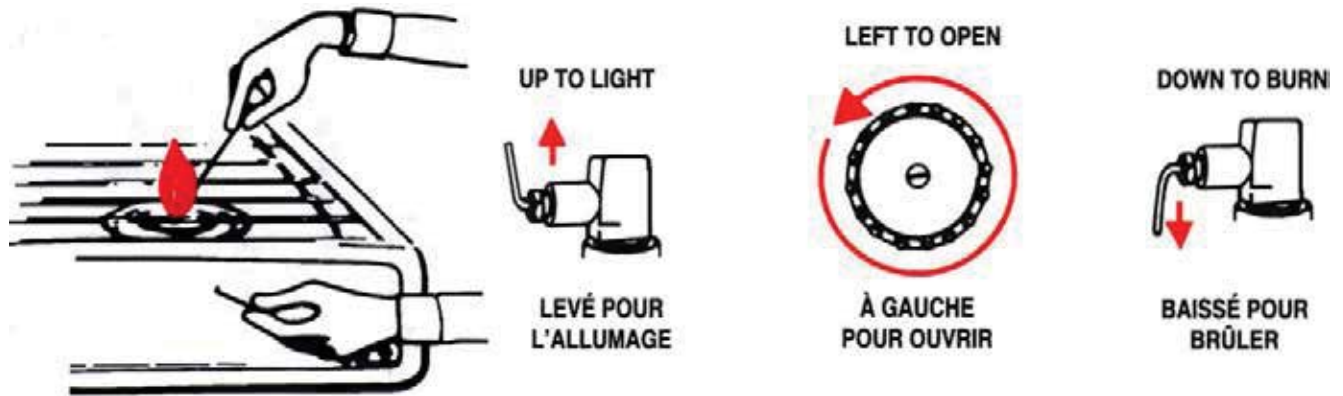

Figure 10 Lighting the Master Burner

Note. From *Coleman Camp Stove Model M425F710C Instructions for use*, by The Canadian Coleman Co., Mississauga, ON: The Coleman Company, Inc.



Should the stove fail to light or the match goes out before ignition, turn the control knob to the OFF position and wait two minutes before attempting to light the stove again.

Lighting the Auxiliary Burner

1. After the master burner has been lit, the auxiliary burner may be lit.
2. Hold a match to the auxiliary burner. Open the auxiliary valve located on the side of the stove box, next to the burner (the master burner may require adjustment after lighting the auxiliary burner).

Extinguishing the Burner

1. Close the auxiliary burner valve.
2. Remove cookware from the stove and turn the instant light lever up to LIGHT position and let burn for one minute. This cleans heavier parts of fuel from the generator.
3. Turn the main valve control knob clockwise to the OFF position and close firmly.



A small flame on the master burner will continue to burn for a few minutes, until the fuel empties from the generator.

DISASSEMBLING AFTER USE

To store a two-burner stove:

1. Allow the stove to cool before packing.
2. Ensure the stove is clean and any dirt, matches, etc. are emptied from the stove box.
3. Ensure the auxiliary burner valve is in the closed position.
4. Open the grate.
5. Remove the safety chain.

6. Uninstall the fuel tank and remove it from the stove box.
7. Unpressurize the fuel tank by loosening the filler cap, then retighten it to reseal the fuel tank. Note: Angle the fuel tank so that the filler cap is highest to reduce possible fuel leakage.
8. Place the fuel tank inside the stove box.
9. Close the grate.
10. Close and fold in the wind baffles.
11. Close the cover and latch the box.

CONFIRMATION OF TEACHING POINT 4

The cadets' participation in operating a stove will serve as the confirmation of this TP.

Teaching Point 5

Explain, demonstrate and have the cadets operate a dual-mantle naphtha lantern.

Time: 20 min

Method: Demonstration and Performance



For this skill, it is recommended that instruction take the following format:

1. Explain and demonstrate the complete skill while cadets observe.
2. Explain and demonstrate each step required to complete the skill. Monitor cadets as they imitate each step.
3. Monitor the cadets' performance as they practice the complete skill.

Note: Assistant instructors may be employed to monitor the cadets' performance.

ASSEMBLING

The lantern does not require assembly or disassembly except when replacing the mantles / globe. Before operating the lantern, the cadet should verify that the handle is in place and that the ball nut (screw on top of the ventilator) is tight.

LIGHTING AND EXTINGUISHING



The lantern should have been fuelled previous to this lesson; however, the lantern should not be pressurized. When a mantle is replaced it should be burned prior to use. By burning the mantle, the mantle shrinks down in size ensuring that combustion of the fuel takes place at the mantle. When the mantle is not burned prior to use fuel can leak out of the mantle prior to combustion.

Pressurizing the Fuel Tank

1. Make sure the control knob is in the OFF position.
2. Turn the pump rod two full turns counter-clockwise.
3. Place the thumb over the air vent of the pump rod handle.

4. Pump 30–40 full strokes to pressurize the fuel tank.
5. Turn the pump rod to clockwise until it is closed tight.

Lighting the Lantern



Do not position the hands or head above the lantern when lighting.

Mantles are very fragile and shall be avoided when using a match to light the lantern.

1. Insert a lit match through the hole in the bottom of the burner frame.
2. Turn the control knob to the LIGHT position.
3. When the mantle burns bright white (after about one minute), turn the control knob to the ON position.
4. Add more air pressure to the tank. Air pressure may be added while the lantern is in operation. Good air pressure is important for maximum light output.

Extinguishing the Lantern

1. Turn the control knob to the OFF position.
2. Allow the remaining fuel to burn off.

STORING AFTER USE

To store a dual-mantle lantern:

1. Ensure the lantern is cool.
2. Wipe and clean away any dirt.
3. Drain the fuel into a fuel storage container (do not drain as the lantern is required for the other groups to use).
4. Place in a cool, dry location.

CONFIRMATION OF TEACHING POINT 5

The cadets' participation in operating a lantern will serve as the confirmation of this TP.

Teaching Point 6**Explain, demonstrate and have the cadets perform minor maintenance on a stove and lantern.**

Time: 15 min

Method: Demonstration and Performance



For this skill, it is recommended that instruction take the following format:

1. Explain and demonstrate the complete skill while cadets observe.
2. Explain and demonstrate each step required to complete the skill. Monitor cadets as they imitate each step.
3. Monitor the cadets' performance as they practice the complete skill.

Note: Assistant instructors may be employed to monitor the cadets' performance.

PERFORM MINOR MAINTENANCE

Stoves and lanterns must be cool to the touch before performing cleaning and any minor maintenance.

Cleaning the Stove

Clean as needed during a field exercise and before storage.

- Fuel tank should be wiped using fresh naphtha as the solvent.
- The burner assemblies should have the remains of matches and food residue (Note: Flame usually burns yellow instead of blue where there are remains and residue).
- Stove box should be washed with soap and water to remove food residue and grease.



The burner assemblies should not be immersed in water as any water left in the tubes will cut-off or restrict the flow of fuel. Burner assemblies should be removed from the stove box and cleaned separately if the stove box is being immersed to be cleaned.

Cleaning the Lantern

Clean as needed during a field exercise and before storage.

- Fuel tank and ventilator should be wiped using fresh naphtha as the solvent.
- Remains of matches should be removed from inside the globe.
- Globe should be carefully cleaned and dried.

Replacing a Mantle

If a mantle has fallen apart or has a hole in it, it should be replaced before operating the lantern.

1. Remove handle by pulling the handle arms gently away from the lantern.
2. Unscrew and remove the ball nut.

3. Remove the ventilator.
4. Remove the globe.
5. Only use the appropriate mantle for the lantern.
6. Remove the remains of the old mantle.
7. Tie mantle around the grooves in the burner cap, with the flat side of the mantle facing the generator (as per Figure 11).
8. Cut off excess string.
9. Light bottom of the mantle evenly, burning until nothing but ash is left.
10. Allow mantle to cool before lighting the lantern.
11. Reassemble the lantern.

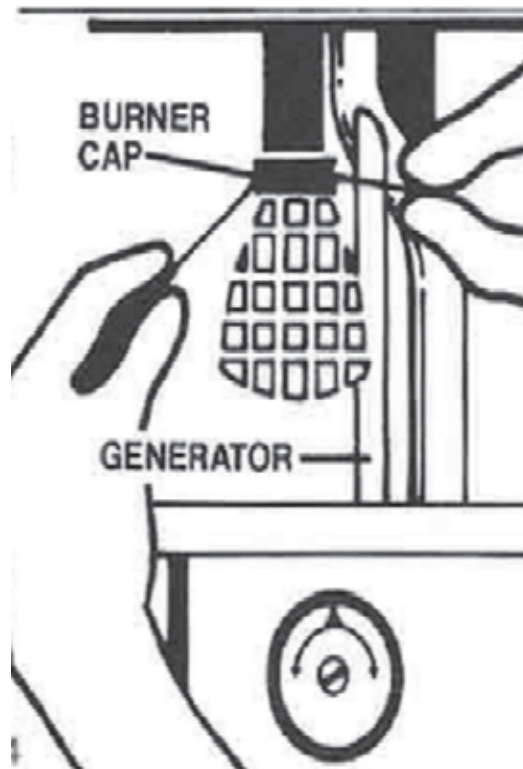

Figure 11 Replacing a Mantle

Note. From Coleman Lantern Model 220K195 & 228K195 How To Use and Enjoy, by The Canadian Coleman Co., Toronto, ON: The Coleman Company, Inc.

Inspecting the Pump Assembly

1. Remove clip from pump cap using needle-nose pliers (as per Figure 12).
2. Turn pump knob counter clockwise several times to unscrew air stem.
3. Pull out pump and air stem (as per Figure 12).
4. Examine pump leather, if dry, work several drops of oil into it.

5. Insert pump and air stem into tank (pump leather must not invert or fold).
6. Replace pump cap and clip.
7. Turn pump knob clockwise several times to screw air stem into the tank.

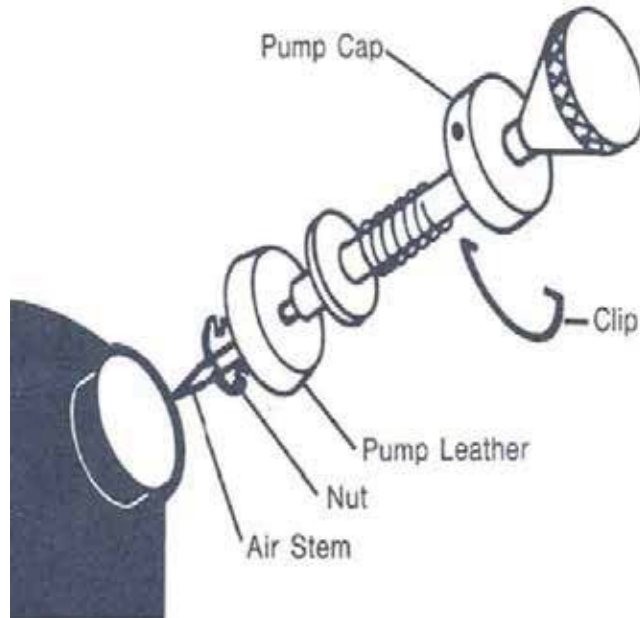

Figure 12 Pump Assembly

Note. From Coleman Lantern Model 220K195 & 228K195 How To Use and Enjoy, by The Canadian Coleman Co., Toronto, ON: The Coleman Company, Inc.

CONFIRMATION OF TEACHING POINT 6

The cadets' participation in performing minor maintenance will serve as the confirmation of this TP.

END OF LESSON CONFIRMATION

The cadets' filling and draining, operating and performing minor maintenance on a two-burner stove and a dual-mantle lantern will serve as confirmation of this lesson.

CONCLUSION

HOMEWORK / READING / PRACTICE

Nil.

METHOD OF EVALUATION

This EO is assessed IAW A-CR-CCP-804/PG-001, *Proficiency Level Four Standard and Plan*, Chapter 3, Annex B, 490 PC.

CLOSING STATEMENT

Knowing how to operate a stove and a lantern will give the cadets the skills needed to help support survival training during field exercises.

INSTRUCTOR NOTES / REMARKS

The spill response kit will be at the fuelling area.

Refer to the manuals for all operations and maintenance of the two-burner naphtha stove and dual-mantle naphtha lantern.

A fire extinguisher will be at each site where stoves and lanterns are being lit.

When cleaning the stove, the fuel tank is to be wiped with fresh naphtha. Protective gloves and clothing are to be worn when completing this task. Acceptable materials for gloves are neoprene, nitrile / viton. It is also recommended that safety glasses, splash goggles, or face shield be worn. Have eye water wash available.

Cadets who are qualified Survival Instructor may assist with this instruction.

REFERENCES

Manuals for stove and lantern types being used.

THIS PAGE INTENTIONALLY LEFT BLANK



ROYAL CANADIAN AIR CADETS
PROFICIENCY LEVEL FOUR
INSTRUCTIONAL GUIDE



SECTION 3

EO M490.03 – TIE KNOTS AND LASHINGS

Total Time:	60 min
-------------	--------

PREPARATION

PRE-LESSON INSTRUCTIONS

Resources needed for the delivery of this lesson are listed in the lesson specification located in A-CR-CCP-804/PG-001, *Proficiency Level Four Qualification Standard and Plan*, Chapter 4. Specific uses for said resources are identified throughout the instructional guide within the TP for which they are required.

Review the lesson content and become familiar with the material prior to delivering the lesson.

Photocopy the knot-tying and lashing instructions located at Attachments A and B for each cadet.

Cut lengths of braided rope for the cadets to tie the knots. The rope should be 10 mm (3/8 inch) in diameter and 3 m (10 feet) in length. Each cadet will require two lengths of rope.

Collect poles from natural resources. Poles should be approximately 2 m in length and 6 cm in diameter. Each cadet will require two poles.

PRE-LESSON ASSIGNMENT

Nil.

APPROACH

An interactive lecture was chosen for TP 1 to present background material on rope terminology.

A demonstration and performance was chosen for TPs 2 and 3 as it allows the instructor to explain and demonstrate tying knots and lashings while providing an opportunity for the cadets to practice and develop these skills under supervision.

INTRODUCTION

REVIEW

Nil.

OBJECTIVES

By the end of this lesson the cadet shall have tied knots and lashings.

IMPORTANCE

It is important for the cadets to know how to tie different knots and lashings in order to construct sturdy shelters, tents, snares and camp crafts.

Teaching Point 1

Describe the parts of a rope.

Time: 10 min

Method: Interactive Lecture

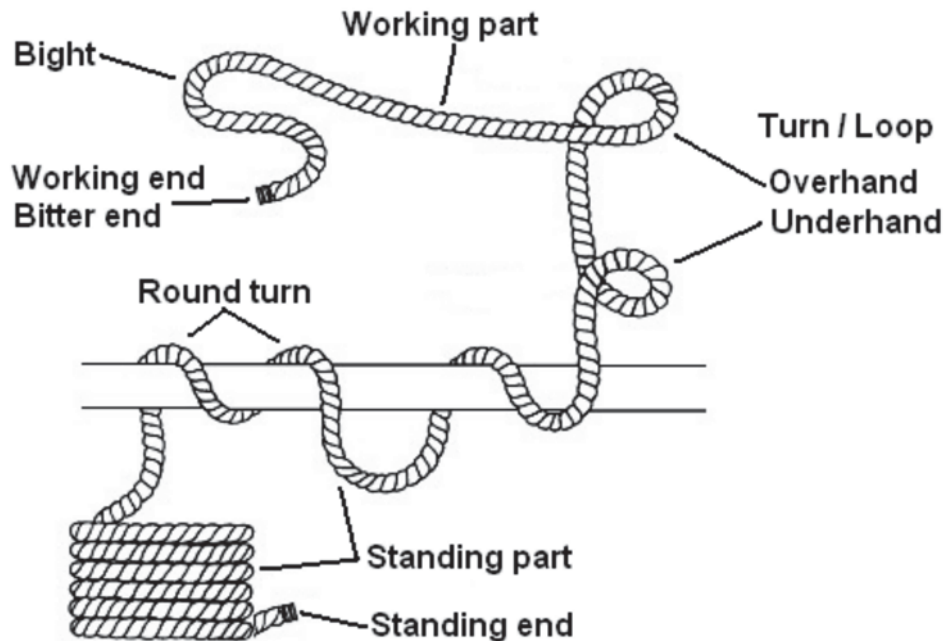

Figure 1 Parts of a Rope

Note. From *Lost Knowledge Site*, by B. Green. 2006. Retrieved March 6, 2009, from <http://lostknowledgesite.com/BackToBasics/Knots/Knots.html>

PARTS OF A ROPE

The following definitions will assist cadets when tying each knot or lashing:

Working end (Bitter end). The very end of the rope that is used for tying a knot.

Working part (Running part). is the short length of rope that is manipulated to make the knot.

Standing end. The end of the rope opposite the end being used for tying a knot.

Standing part. The section of rope that usually “stands still” during the knot-tying process. Often it is the longer end that leads away from the loop, bight or knot.

Turn or Loop. A part of rope that crosses over itself. The working part can be over or under the standing part in a crossing turn.

Bight. A loop in the rope that does not cross over itself.

CONFIRMATION OF TEACHING POINT 1**QUESTIONS:**

- Q1. What part of the rope is called the working part?
- Q2. What is a bight?
- Q3. What is the standing end?

ANTICIPATED ANSWERS:

- A1. The working part (running part) is the short length of rope that is manipulated to make the knot.
- A2. A bight is a loop in the rope that does not cross over itself.
- A3. The standing end is the end of the rope opposite the end being used for tying a knot.

Teaching Point 2**Explain, demonstrate and have the cadets tie knots.**

Time: 20 min

Method: Demonstration and Performance



For this skill lesson, it is recommended that the instructor take the following format:

1. Explain and demonstrate the complete knot while cadets observe.
2. Explain and demonstrate each step required to complete the knot. Monitor cadets as they imitate each step.
3. Monitor the cadets' performance as they practice the complete knot.

Note: Assistant instructors may be used to monitor the cadets' performance.

KNOTS

Reef knot. The reef knot is used for joining two ropes of equal diameter together. This knot can hold a moderate amount of weight and is ideal for first aid. It may be used when tying slings because the knot lies flat against the body.

Steps for Tying a Reef Knot

1. Place the left-hand working end on the top of the right-hand working end.

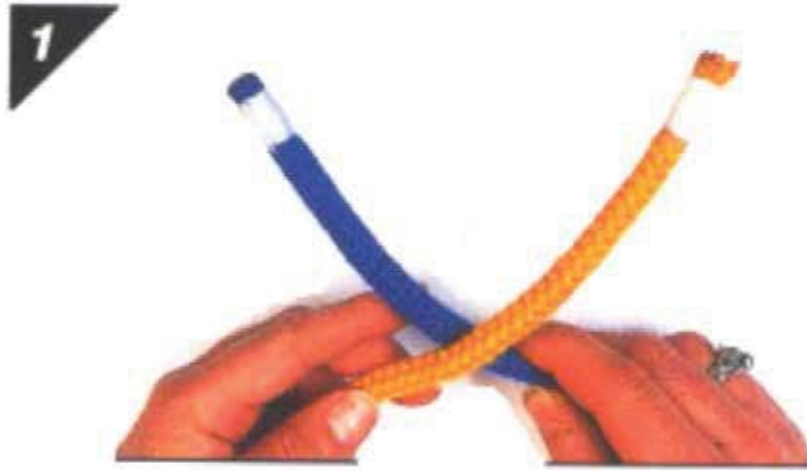

Figure 2 Step 1

Note. From *Pocket Guide to Knots and Splices* (p. 98), by D. Pawson, 2001, London, England: Prospero Books Inc. Copyright 2001 by PRC Publishing Ltd.

2. Bring the left-hand working end under the right-hand working end.



Figure 3 Step 2

Note. From *Pocket Guide to Knots and Splices* (p. 98), by D. Pawson, 2001, London, England: Prospero Books Inc. Copyright 2001 by PRC Publishing Ltd.

3. Place the working end that is now on the right, on top of the working end that is now on the left.



Figure 4 Step 3

Note. From *Pocket Guide to Knots and Splices* (p. 98), by D. Pawson, 2001, London, England: Prospero Books Inc. Copyright 2001 by PRC Publishing Ltd.

4. Bring the working end that is on top under the other working end so it comes out at the same place it entered the knot.



Figure 5 Step 4

Note. From *Pocket Guide to Knots and Splices* (p. 98), by D. Pawson, 2001, London, England: Prospero Books Inc. Copyright 2001 by PRC Publishing Ltd.

5. Pull tight to complete the reef knot.



Figure 6 Step 5

Note. From *Pocket Guide to Knots and Splices* (p. 98), by D. Pawson, 2001, London, England: Prospero Books Inc. Copyright 2001 by PRC Publishing Ltd.

Figure-of-eight knot. The figure-of-eight knot is very simple and quick to tie. It makes an ideal stopper knot and is very easy to untie.

Steps for Tying a Figure-of-Eight Knot

1. Make a crossing turn with the working end passing under the standing part of the rope and then bring the working end over the standing part.

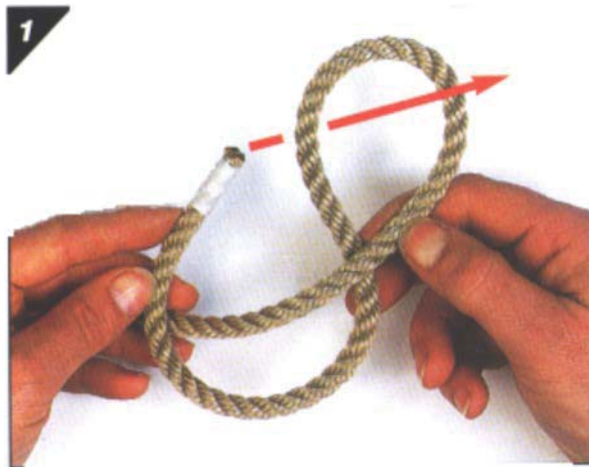

Figure 7 Step 1

Note. From *Pocket Guide to Knots and Splices* (p. 44), by D. Pawson, 2001, London, England: Prospero Books Inc. Copyright 2001 by PRC Publishing Ltd.

- Now tuck the working end up through the loop from behind, forming a figure-of-eight.



Figure 8 Step 2

Note. From *Pocket Guide to Knots and Splices* (p. 44), by D. Pawson, 2001, London, England: Prospero Books Inc. Copyright 2001 by PRC Publishing Ltd.

- Pull tight to complete the figure-of-eight knot.



Figure 9 Step 3

Note. From *Pocket Guide to Knots and Splices* (p. 44), by D. Pawson, 2001, London, England: Prospero Books Inc. Copyright 2001 by PRC Publishing Ltd.

Clove hitch. The clove hitch consists of two half hitches or crossing turns each made in the same direction. It is used to finish and start lashings and should not be used in a situation where the hitch has variable tension as it can work loose.

Steps for Tying a Clove Hitch

1. Make a turn around a pole / tree bringing the working end of the rope over and trapping the standing part of the rope. This makes the first half hitch.



Figure 10 Step 1

Note. From *Pocket Guide to Knots and Splices* (p. 106), by D. Pawson, 2001, London, England: Prospero Books Inc. Copyright 2001 by PRC Publishing Ltd.

2. Bring the working end behind the pole / tree, above the first half hitch.



Figure 11 Step 2

Note. From *Pocket Guide to Knots and Splices* (p. 106), by D. Pawson, 2001, London, England: Prospero Books Inc. Copyright 2001 by PRC Publishing Ltd.

- Put the working end under the turn just made. This gives the second half hitch and forms the clove hitch.



Figure 12 Step 3

Note. From *Pocket Guide to Knots and Splices* (p. 106), by D. Pawson, 2001, London, England: Prospero Books Inc. Copyright 2001 by PRC Publishing Ltd.

- Pull tight to complete the clove hitch.



Figure 13 Step 4

Note. From *Pocket Guide to Knots and Splices* (p. 106), by D. Pawson, 2001, London, England: Prospero Books Inc. Copyright 2001 by PRC Publishing Ltd.

Bowline. The bowline is a very secure knot that will not slip, regardless of the load applied. Use this knot whenever a non-slip loop is required at the end of a line.

Steps to Tying a Bowline

1. A short distance back from the working end, make a crossing turn with the working part on top. Go on to form the size of the loop you require.



Figure 14 Step 1

Note. From *Pocket Guide to Knots and Splices* (p. 163), by D. Pawson, 2001, London, England: Prospero Books Inc. Copyright 2001 by PRC Publishing Ltd.

2. Bring the working end up through the crossing turn. It will go under first, and then lie on top of the other part of the turn.



Figure 15 Step 2

Note. From *Pocket Guide to Knots and Splices* (p. 163), by D. Pawson, 2001, London, England: Prospero Books Inc. Copyright 2001 by PRC Publishing Ltd.

3. Bring the working end around behind the standing part and down through the crossing turn. A good way to remember this is: “the rabbit comes out of the hole, around the tree and back down the hole again”.



Figure 16 Step 3

Note. From *Pocket Guide to Knots and Splices* (p. 163), by D. Pawson, 2001, London, England: Prospero Books Inc. Copyright 2001 by PRC Publishing Ltd.

4. Pull tight by holding the working end and pulling on the standing part to complete the bowline.



Figure 17 Step 4

Note. From *Pocket Guide to Knots and Splices* (p. 163), by D. Pawson, 2001, London, England: Prospero Books Inc. Copyright 2001 by PRC Publishing Ltd.



Distribute Attachment A to the cadets, so they may practice the knots after the lesson.

CONFIRMATION OF TEACHING POINT 2

The cadets' participation in tying knots will serve as the confirmation of this TP.

Teaching Point 3**Explain, demonstrate and have the cadets tie lashings.**

Time: 20 min

Method: Demonstration and Performance



For this skill, it is recommended that the instruction take the following format:

1. Explain and demonstrate the complete lashing while cadets observe.
2. Explain and demonstrate each step required to complete the lashing. Monitor cadets as they imitate each step.
3. Monitor the cadets' performance as they practice the complete lashing.

Note: Assistant instructors may be used to monitor the cadets' performance.

LASHINGS

Round lashing. Sometimes called a sheer lashing, the round lashing has two distinct uses. First, it creates an "A" frame or set of using a single lashing. Second, two or three round lashings can be used to bind together a couple of poles to make a longer spar. To make an "A" frame, two poles are put side by side; the lashing is made at one end as illustrated in Figures 18–24. A slightly different approach is used to join two poles together to make a longer pole. The procedure is exactly the same, except the initial and final clove hitches are tied around both poles and there is no space left between the poles and no frapping is used. For extra strength to the spar, add extra lashings at the opposite end and middle of the adjoining poles.

Steps to Tying a Round Lashing

1. Start by making a clove hitch around both poles.



Figure 18 Step 1

Note. From *Pocket Guide to Knots and Splices* (p. 184), by D. Pawson, 2001, London, England: Prospero Books Inc. Copyright 2001 by PRC Publishing Ltd.

2. Wrap around both poles, trapping the end of the clove hitch.

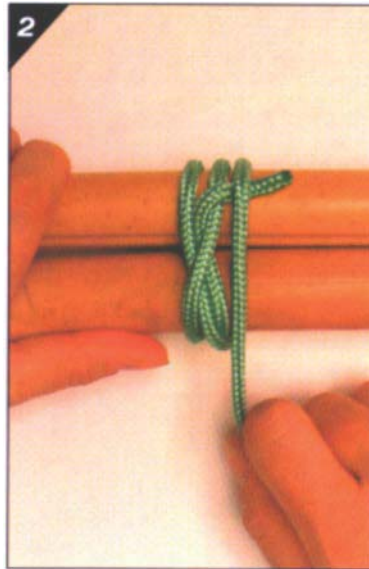

Figure 19 Step 2

Note. From *Pocket Guide to Knots and Splices* (p. 184), by D. Pawson, 2001, London, England: Prospero Books Inc. Copyright 2001 by PRC Publishing Ltd.

3. Carry on making eight to ten more turns round the pair of poles.



Figure 20 Step 3

Note. From *Pocket Guide to Knots and Splices* (p. 184), by D. Pawson, 2001, London, England: Prospero Books Inc. Copyright 2001 by PRC Publishing Ltd.

4. The lashing could now be finished with a clove hitch around both poles or put in a couple of frapping turns by bringing the end of the rope between the two poles.



Figure 21 Step 4

Note. From *Pocket Guide to Knots and Splices* (p. 185), by D. Pawson, 2001, London, England: Prospero Books Inc. Copyright 2001 by PRC Publishing Ltd.

5. Finish off with a clove hitch around one of the poles.



Figure 22 Step 5

Note. From *Pocket Guide to Knots and Splices* (p. 185), by D. Pawson, 2001, London, England: Prospero Books Inc. Copyright 2001 by PRC Publishing Ltd.

6. Pull tight to finish the round lashing with the poles parallel.

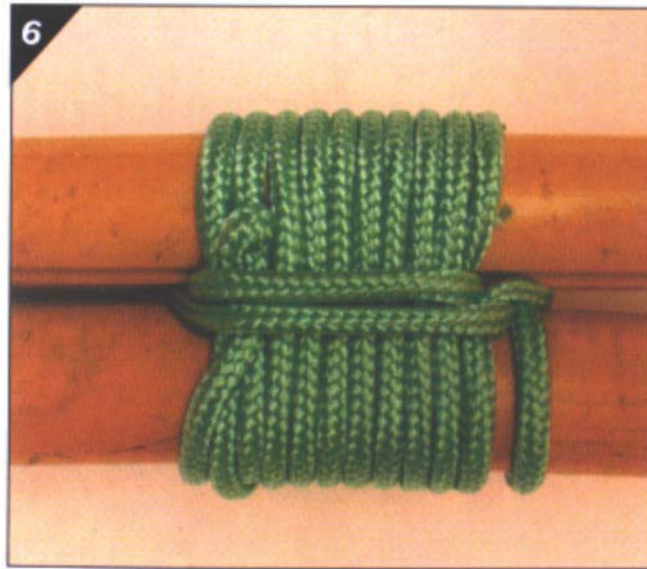

Figure 23 Step 6

Note. From *Pocket Guide to Knots and Splices* (p. 185), by D. Pawson, 2001, London, England: Prospero Books Inc. Copyright 2001 by PRC Publishing Ltd.

7. If being used for an "A" frame then open the poles.



Figure 24 Step 7

Note. From *Pocket Guide to Knots and Splices* (p. 185), by D. Pawson, 2001, London, England: Prospero Books Inc. Copyright 2001 by PRC Publishing Ltd.

Square lashing. A square lashing secures two poles together at 90 degrees and can be used in the construction of shelters and camp crafts. The cord used to make the lashing should be considerably smaller than the size of the poles. For the lashing to be effective, each turn must be pulled as tight as possible as it is made.

Steps to Tying a Square Lashing

1. With the vertical pole on top of the horizontal pole, make a clove hitch on the vertical pole just below the horizontal pole.

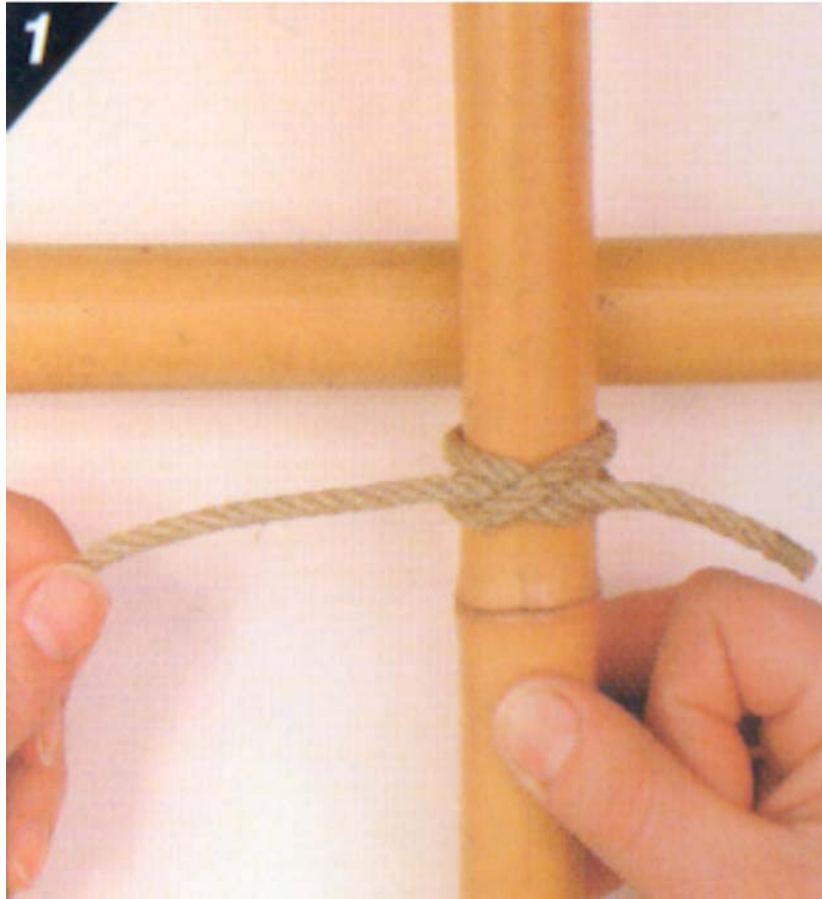

Figure 25 Step 1

Note. From *Pocket Guide to Knots and Splices* (p. 181), by D. Pawson, 2001, London, England: Prospero Books Inc. Copyright 2001 by PRC Publishing Ltd.

2. Bring all the cord around behind the horizontal pole.



Figure 26 Step 2

Note. From *Pocket Guide to Knots and Splices* (p. 181), by D. Pawson, 2001, London, England: Prospero Books Inc. Copyright 2001 by PRC Publishing Ltd.

3. Bring the cord over the vertical pole and back behind the horizontal pole to the clove hitch. Pull tight.



Figure 27 Step 3

Note. From *Pocket Guide to Knots and Splices* (p. 181), by D. Pawson, 2001, London, England: Prospero Books Inc. Copyright 2001 by PRC Publishing Ltd.

4. Carry on making two or three more complete turns around the two poles, pulling tight after each turn.

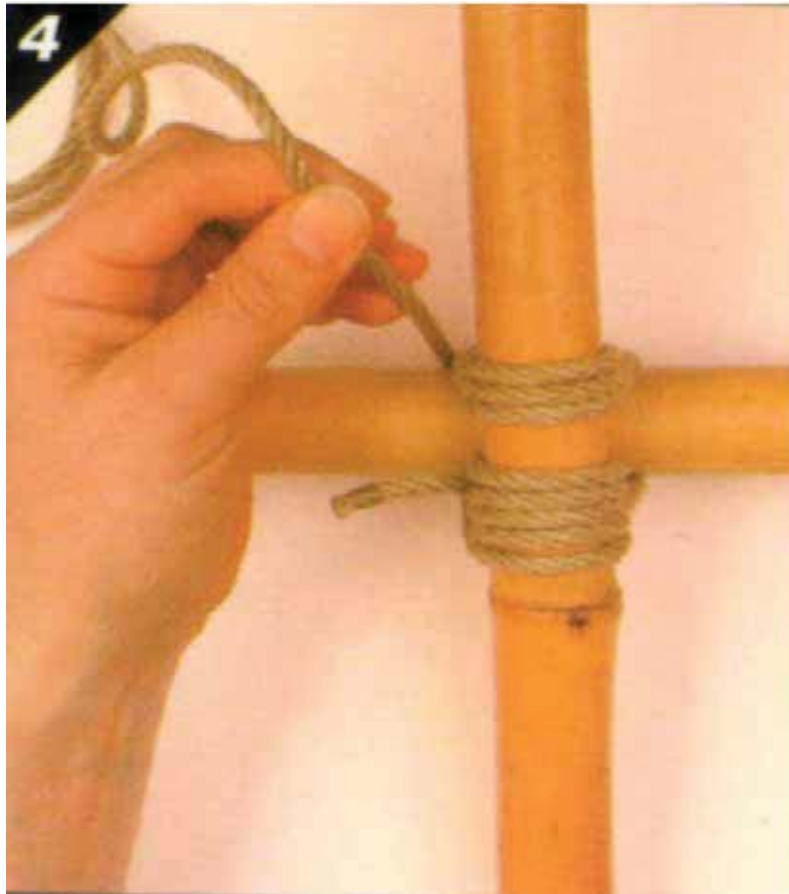

Figure 28 Step 4

Note. From *Pocket Guide to Knots and Splices* (p. 181), by D. Pawson, 2001, London, England: Prospero Books Inc. Copyright 2001 by PRC Publishing Ltd.

5. After passing the clove hitch, bring the cord around the horizontal pole from behind and start to wrap around the junction between the two poles. These are frapping turns—pull them as tight as possible.

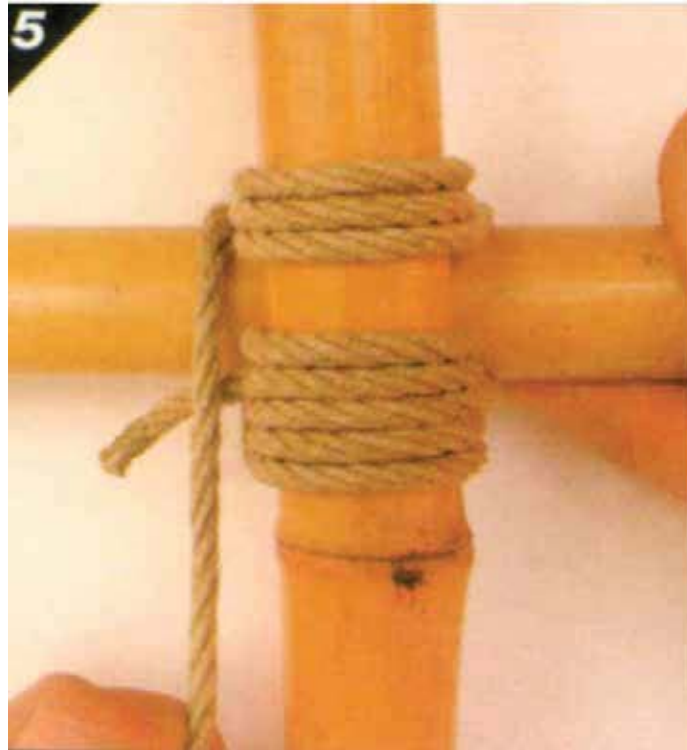

Figure 29 Step 5

Note. From *Pocket Guide to Knots and Splices* (p. 181), by D. Pawson, 2001, London, England: Prospero Books Inc. Copyright 2001 by PRC Publishing Ltd.

6. Make two frapping turns.



Figure 30 Step 6

Note. From *Pocket Guide to Knots and Splices* (p. 181), by D. Pawson, 2001, London, England: Prospero Books Inc. Copyright 2001 by PRC Publishing Ltd.

7. Finish off with a clove hitch around the horizontal pole.



Figure 31 Step 7

Note. From *Pocket Guide to Knots and Splices* (p. 181), by D. Pawson, 2001, London, England: Prospero Books Inc. Copyright 2001 by PRC Publishing Ltd.

8. Pull tight to complete the square lashing.



Figure 32 Step 8

Note. From *Pocket Guide to Knots and Splices* (p. 181), by D. Pawson, 2001, London, England: Prospero Books Inc. Copyright 2001 by PRC Publishing Ltd.

Figure-of-eight lashing. The figure-of-eight lashing is used to join three poles together to create a tripod. The tripod can be used for creating signal fires, shelters and camp crafts in a survival situation.

Steps to Lashing a Figure-of-Eight Lashing

1. Start with a clove hitch around one of the poles, and lead the rope under and over the other two poles.



Figure 33 Step 1

Note. From *Pocket Guide to Knots and Splices* (p. 187), by D. Pawson, 2001, London, England: Prospero Books Inc. Copyright 2001 by PRC Publishing Ltd.

2. Go around the pole furthest away from the start and weave the rope back over and under.



Figure 34 Step 2

Note. From *Pocket Guide to Knots and Splices* (p. 187), by D. Pawson, 2001, London, England: Prospero Books Inc. Copyright 2001 by PRC Publishing Ltd.

3. Continue to weave the rope in the figure-of-eight manner for seven or eight full passes before bringing the rope up between two of the poles.

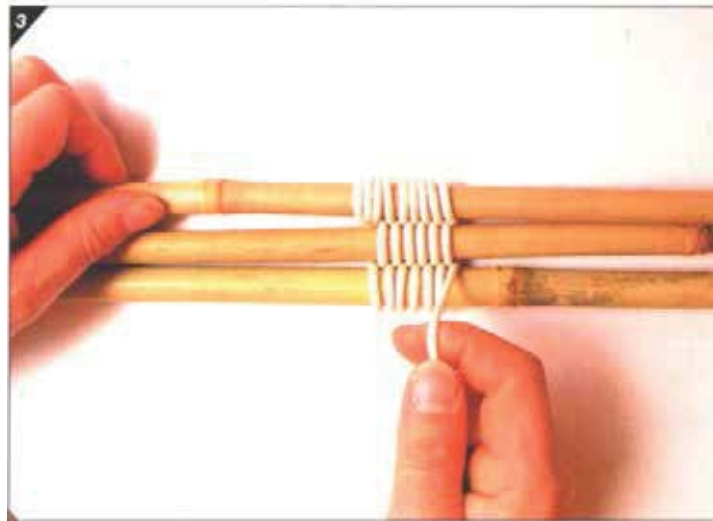

Figure 35 Step 3

Note. From *Pocket Guide to Knots and Splices* (p. 187), by D. Pawson, 2001, London, England: Prospero Books Inc. Copyright 2001 by PRC Publishing Ltd.

4. Pull the rope parallel to the poles and start to put in some frapping turns.

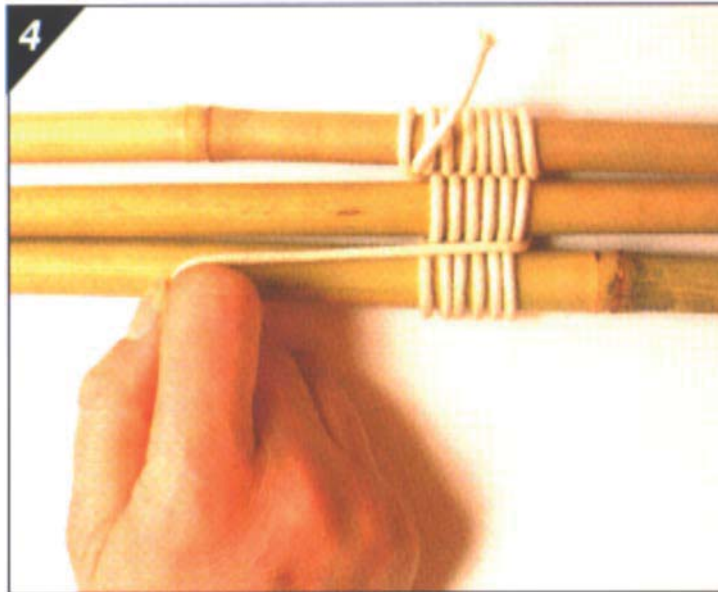

Figure 36 Step 4

Note. From *Pocket Guide to Knots and Splices* (p. 188), by D. Pawson, 2001, London, England: Prospero Books Inc. Copyright 2001 by PRC Publishing Ltd.

5. After making frapping turns between the first two poles move on to make frapping turns around the other pair of poles.

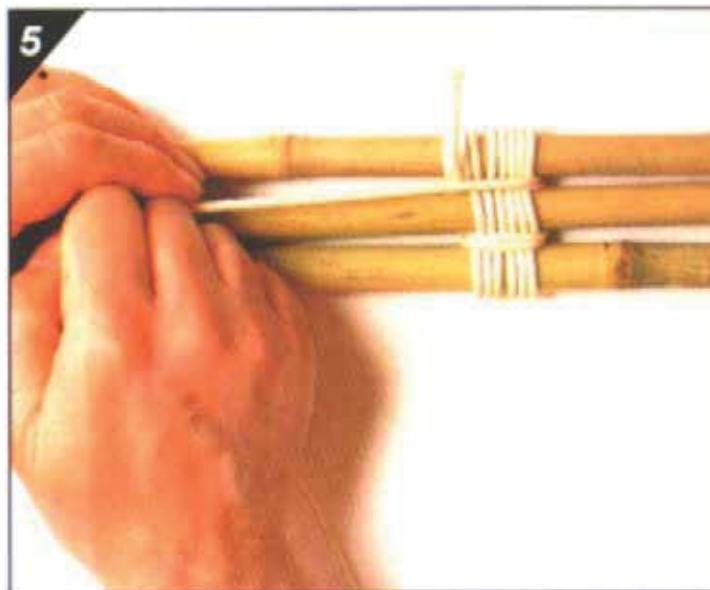

Figure 37 Step 5

Note. From *Pocket Guide to Knots and Splices* (p. 188), by D. Pawson, 2001, London, England: Prospero Books Inc. Copyright 2001 by PRC Publishing Ltd.

6. Finish off with a clove hitch around the pole from which you first started.

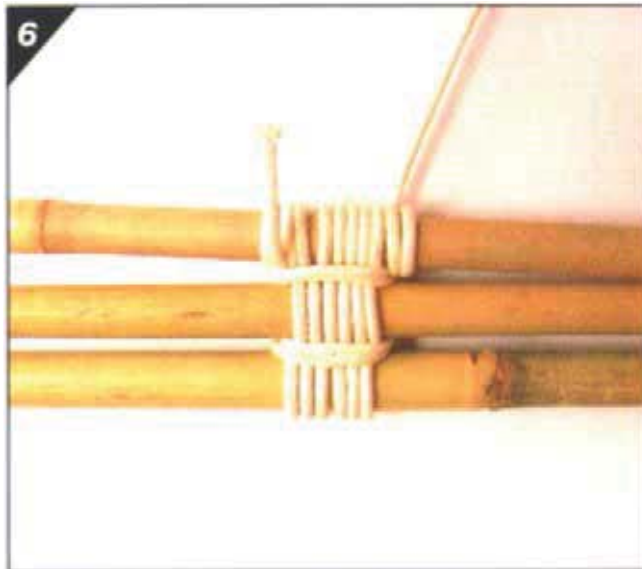

Figure 38 Step 6

Note. From *Pocket Guide to Knots and Splices* (p. 188), by D. Pawson, 2001, London, England: Prospero Books Inc. Copyright 2001 by PRC Publishing Ltd.

7. Open to create tripod.



Figure 39 Step 7

Note. From *Pocket Guide to Knots and Splices* (p. 188), by D. Pawson, 2001, London, England: Prospero Books Inc. Copyright 2001 by PRC Publishing Ltd.



Distribute Attachment B to the cadets, so they may practice the knots after the lesson.

CONFIRMATION OF TEACHING POINT 3

The cadets' participation in tying lashings will serve as the confirmation of this TP.

END OF LESSON CONFIRMATION

The cadets' participation in tying knots and lashing will serve as the confirmation of this lesson.

CONCLUSION

HOMEWORK / READING / PRACTICE

Nil.

METHOD OF EVALUATION

This EO is assessed IAW A-CR-CCP-804/PG-001, *Proficiency Level Four Standard and Plan*, Chapter 3, Annex B, 490 PC.

CLOSING STATEMENT

It is important for the cadets to select the appropriate knot and lashing when constructing shelters, signal fires or camp crafts for safety and quality.

INSTRUCTOR NOTES / REMARKS

Cadets who are qualified Survival Instructor may assist with this instruction.

REFERENCES

C3-026 ISBN 1-55267-218-2 Pawson, D. (2001). *Pocket guide to knots and splices*. London, England: PRC Publishing.

KNOT-TYING INSTRUCTIONS

REEF KNOT

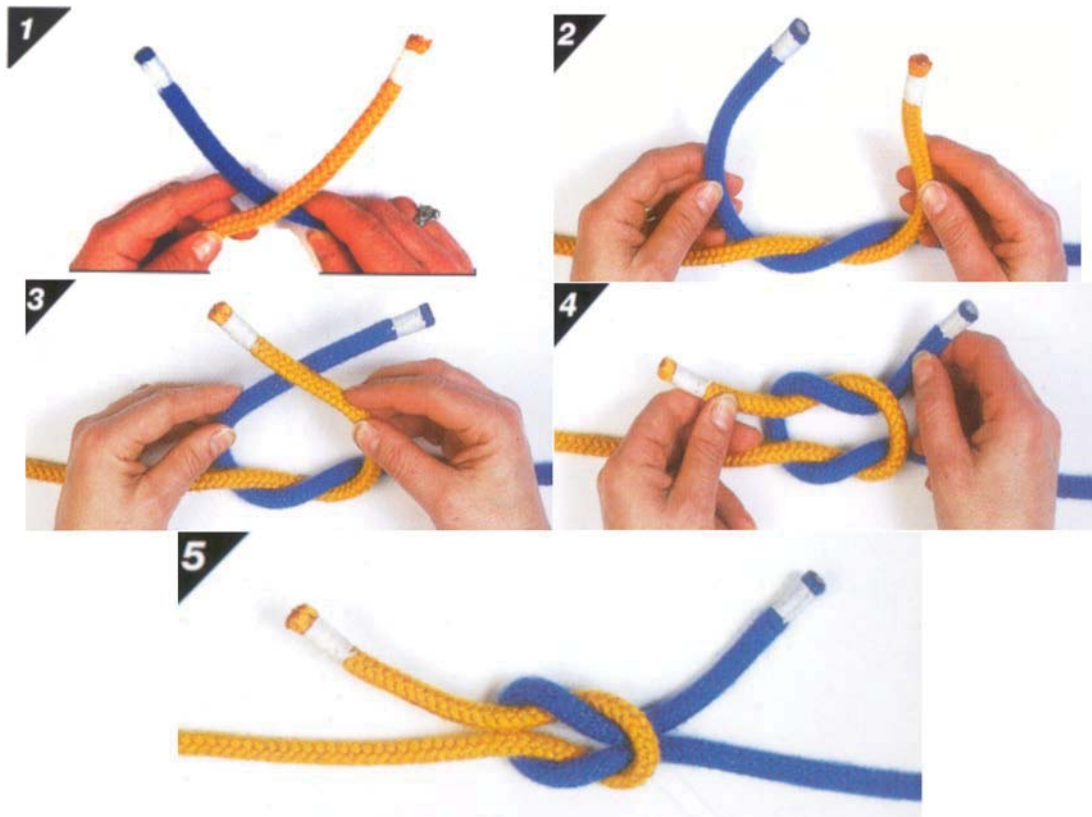

Figure A-1 Steps 1–5

Note. From *Pocket Guide to Knots and Splices* (p. 98), by D. Pawson, 2001, London, England: Prospero Books Inc. Copyright 2001 by PRC Publishing Ltd.

1. Place the left-hand working end on the top of the right-hand working end.
2. Bring the left-hand working end under the right-hand working end.
3. Place the working end that is now on the right on top of the working end that is now on the left.
4. Bring the working end that is on top under the other working end so that working end that is moving comes out at the same place it entered the knot.
5. Pull tight to complete the reef knot.

KNOT-TYING INSTRUCTIONS

FIGURE-OF-EIGHT KNOT



Figure A-2 Steps 1–3

Note. From *Pocket Guide to Knots and Splices* (p. 44), by D. Pawson, 2001, London, England: Prospero Books Inc. Copyright 2001 by PRC Publishing Ltd.

1. Make a crossing turn with the working end passing under the standing part of the rope and then bring the working end over the standing part.
2. Now tuck the working end up through the loop from behind, forming a figure-of-eight.
3. Pull tight to complete the figure-of-eight knot.

KNOT-TYING INSTRUCTIONS

CLOVE HITCH

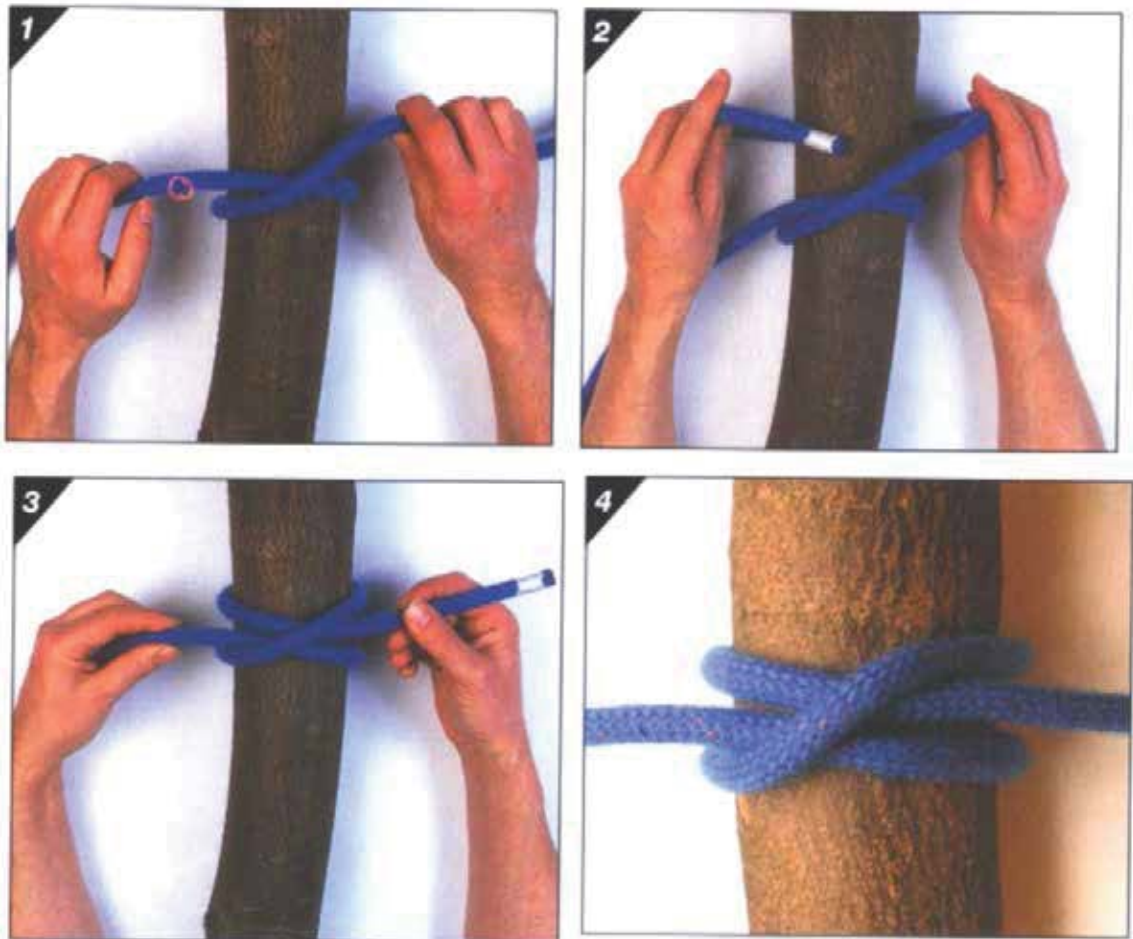

Figure A-3 Steps 1–4

Note. From *Pocket Guide to Knots and Splices* (p. 106), by D. Pawson, 2001, London, England: Prospero Books Inc. Copyright 2001 by PRC Publishing Ltd.

1. Make a turn around the pole / tree bringing the working end of the rope over and trapping the standing part of the rope. This makes the first half hitch.
2. Bring the working end round behind the pole / tree, above the first half hitch.
3. Put the working end under the turn just made. This gives the second half hitch and forms the clove hitch.
4. Pull tight to complete the clove hitch.

KNOT-TYING INSTRUCTIONS

BOWLINE

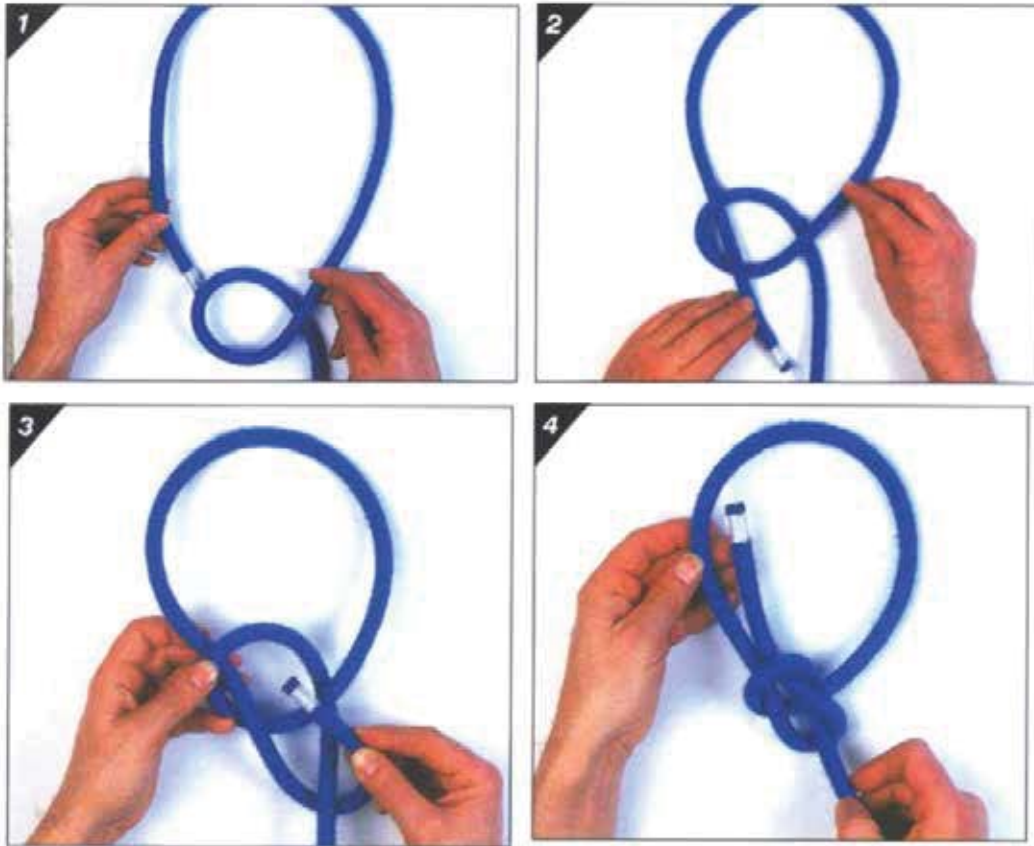

Figure A-4 Steps 1–4

Note. From *Pocket Guide to Knots and Splices* (p. 163), by D. Pawson, 2001, London, England: Prospero Books Inc. Copyright 2001 by PRC Publishing Ltd.

1. A short distance back from the working end, make a crossing turn with the working part on top. Go on to form the size of the loop you require.
2. Bring the working end up through the crossing turn. It will go under first, and then lie on top of the other part of the turn.
3. Bring the working end around behind the standing part and down through the crossing turn. A good way to remember this is: “the rabbit comes out of the hole, around the tree and back down the hole again”.
4. Pull tight by holding the working end and pulling on the standing part to complete the bowline.

LASHING INSTRUCTIONS

ROUND LASHING

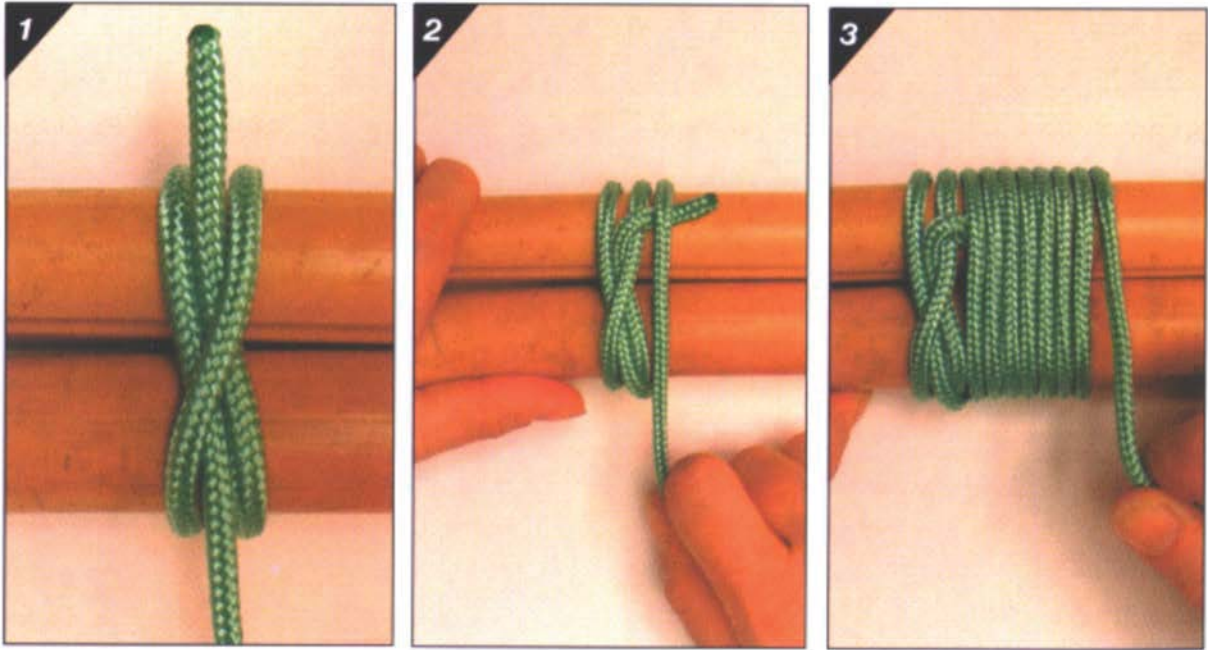

Figure B-1 Steps 1–3

Note. From *Pocket Guide to Knots and Splices* (p. 184), by D. Pawson, 2001, London, England: Prospero Books Inc. Copyright 2001 by PRC Publishing Ltd.

1. Start by making a clove hitch around both poles.
2. Wrap around both poles, trapping the end of the clove hitch.
3. Carry on making eight to ten more turns round the pair of poles.

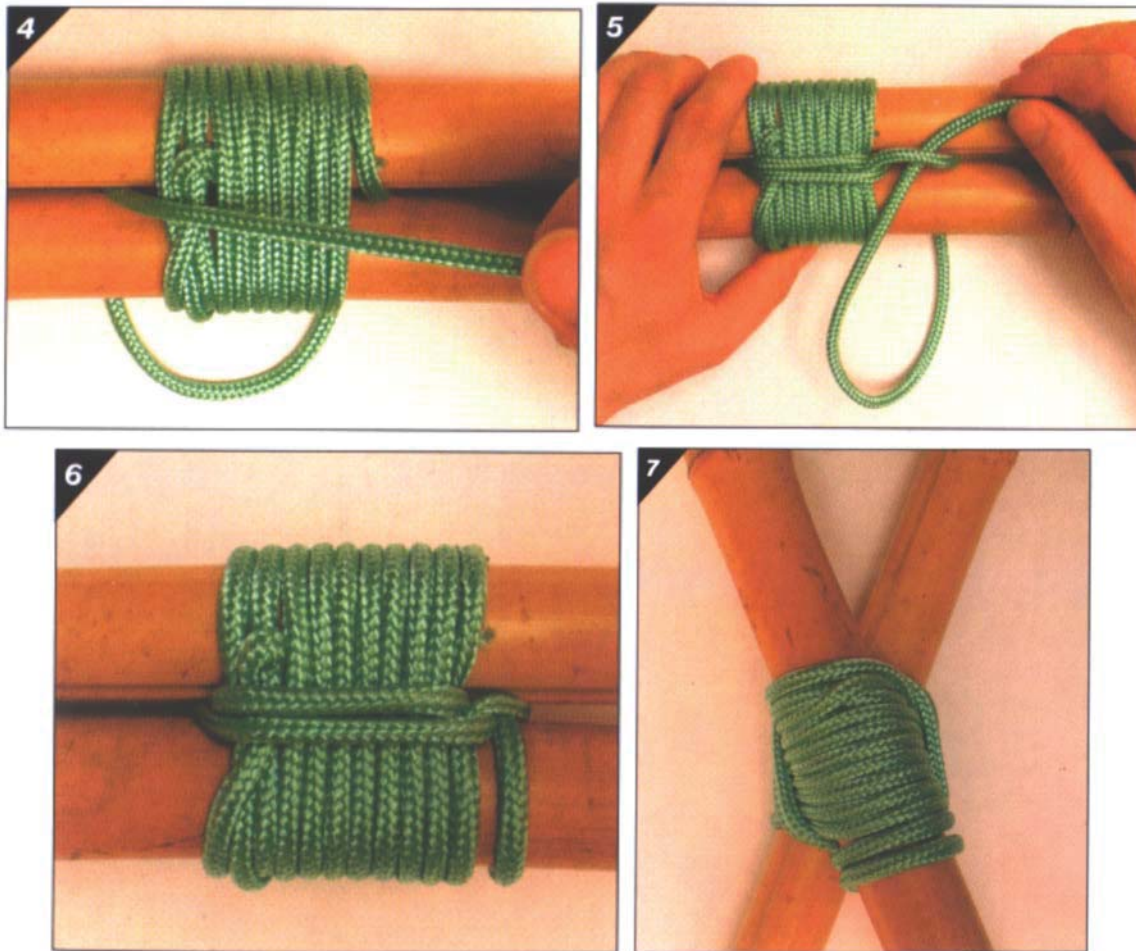

Figure B-2 Steps 4–7

Note. From *Pocket Guide to Knots and Splices* (p. 185), by D. Pawson, 2001, London, England: Prospero Books Inc. Copyright 2001 by PRC Publishing Ltd.

4. The lashing could now be finished with a clove hitch around both poles or put in a couple of frapping turns by bringing the end of the rope between the two poles.
5. Finish off with a clove hitch around one of the poles.
6. Pull tight to finish the round lashing with the poles parallel.
7. If being used for an "A" frame then open the poles.

LASHING INSTRUCTIONS

SQUARE LASHING

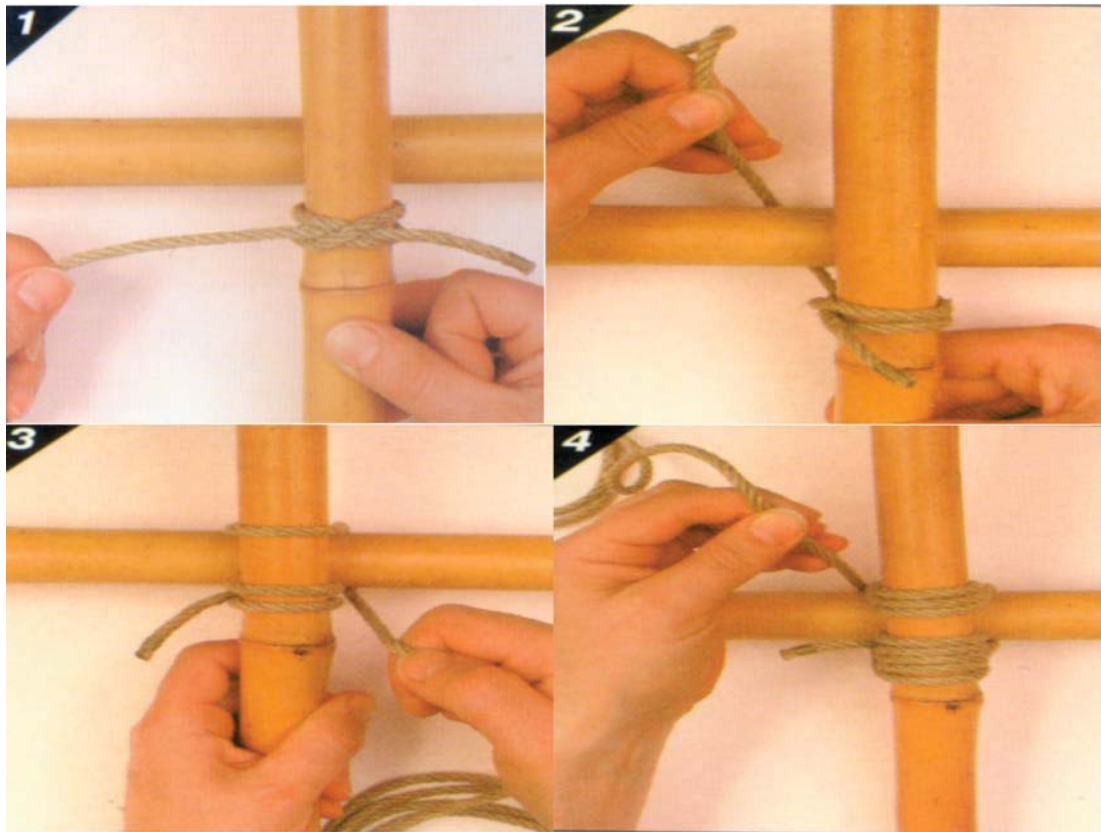

Figure B-3 Steps 1–4

Note. From *Pocket Guide to Knots and Splices* (p. 181), by D. Pawson, 2001, London, England: Prospero Books Inc. Copyright 2001 by PRC Publishing Ltd.

1. With the vertical pole on top of the horizontal pole, make a clove hitch on the vertical pole just below the horizontal pole.
2. Bring all the cord around behind the horizontal pole.
3. Bring the cord over the vertical pole and back behind the horizontal pole to the clove hitch. Pull tight.
4. Carry on making two or three more complete turns around the two poles, pulling tight after each turn.

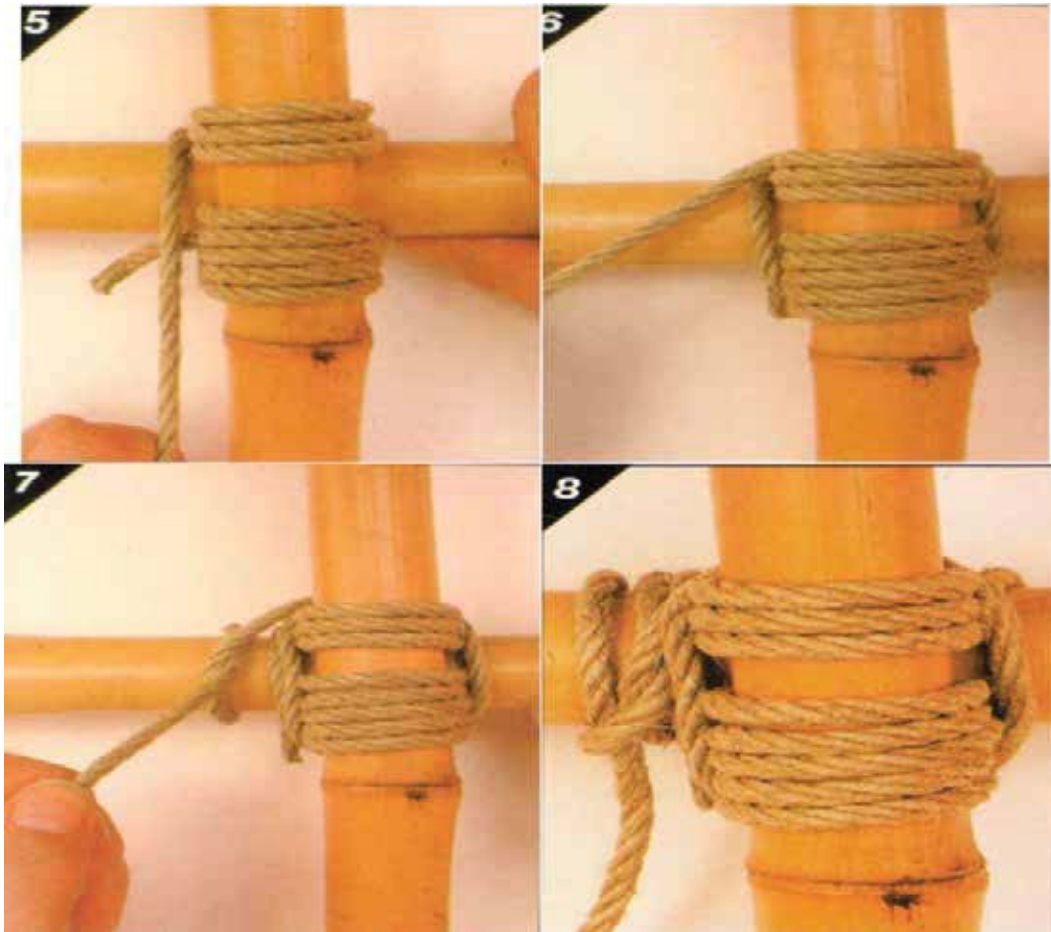

Figure B-4 Steps 5–8

*Note. From *Pocket Guide to Knots and Splices* (p. 181), by D. Pawson, 2001, London, England: Prospero Books Inc. Copyright 2001 by PRC Publishing Ltd.*

5. After passing the clove hitch, bring the cord around the horizontal pole from behind and start to wrap around the junction between the two poles. These are frapping turns—pull them as tight as possible.
6. Make two frapping turns.
7. Finish off with a clove hitch around the horizontal pole.
8. Pull tight to complete the square lashing.

LASHING INSTRUCTIONS

FIGURE-OF-EIGHT LASHING

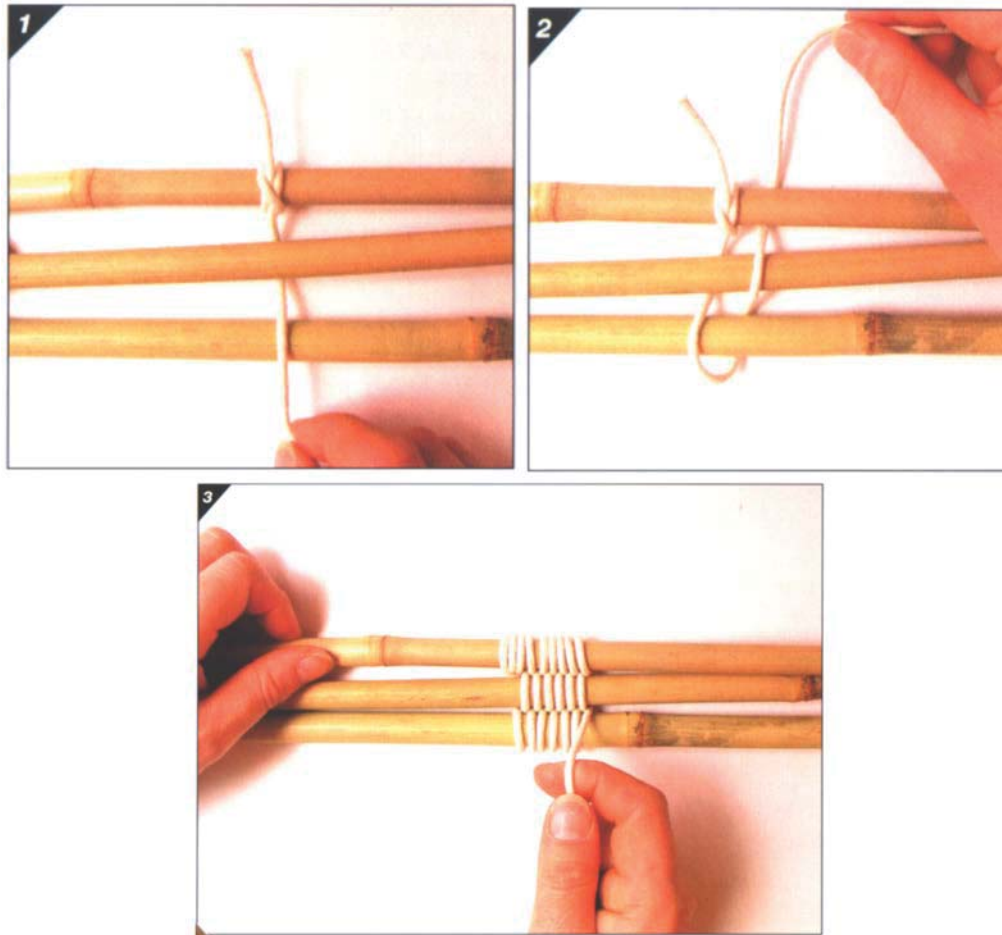

Figure B-5 Steps 1–4

Note. From *Pocket Guide to Knots and Splices* (p. 187), by D. Pawson, 2001, London, England: Prospero Books Inc. Copyright 2001 by PRC Publishing Ltd.

1. Start with a clove hitch around one of the poles, and lead the rope under and over the other two poles.
2. Go around the pole furthest away from the start and weave the rope back over and under.
3. Continue to weave the rope in the figure-of-eight manner for seven or eight full passes before bringing the rope up between two of the poles.

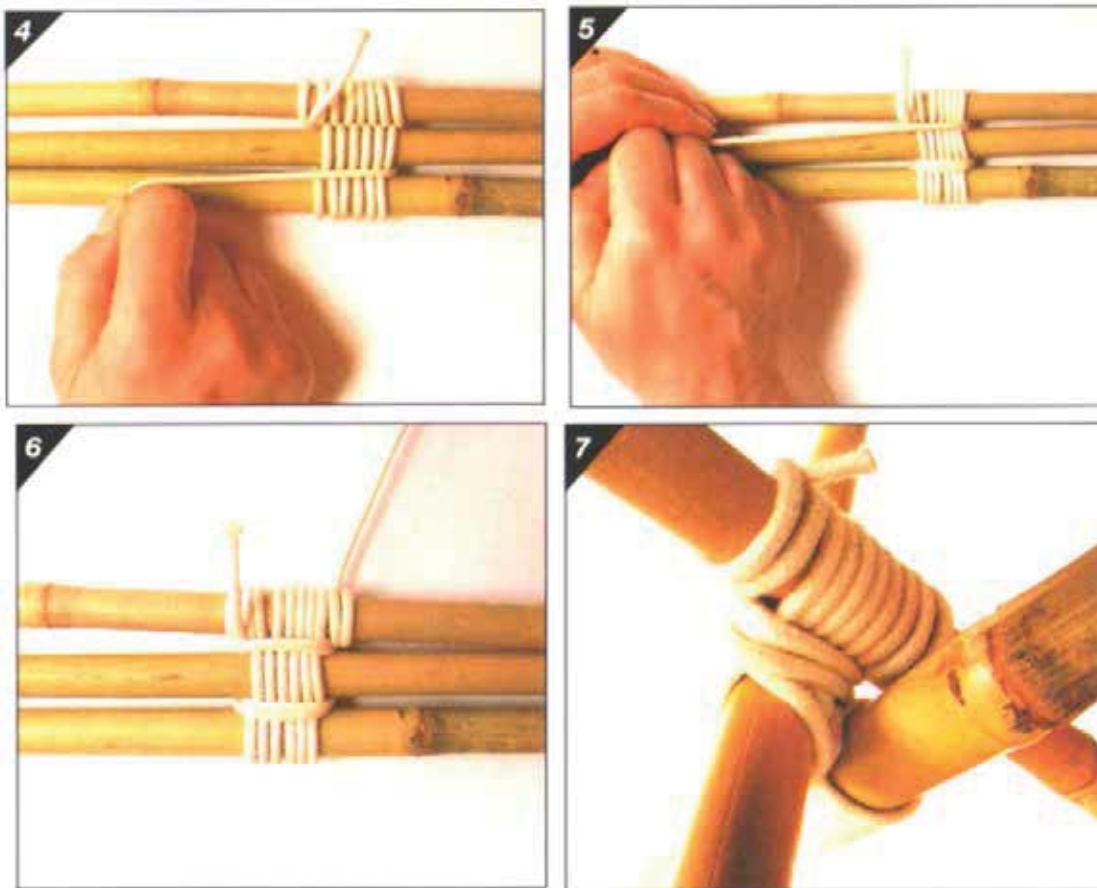

Figure B-6 Steps 4–7

Note. From *Pocket Guide to Knots and Splices* (p. 188), by D. Pawson, 2001, London, England: Prospero Books Inc. Copyright 2001 by PRC Publishing Ltd.

4. Pull the rope parallel to the poles and start to put in some frapping turns.
5. After making frapping turns between the first two poles move on to make frapping turns around the other pair of poles.
6. Finish off with a clove hitch around the pole from which you first started.
7. Open to create tripod.



ROYAL CANADIAN AIR CADETS
PROFICIENCY LEVEL FOUR
INSTRUCTIONAL GUIDE



SECTION 4

**EO M490.04 – NAVIGATE TO A WAYPOINT USING A
 GLOBAL POSITIONING SYSTEM (GPS) RECEIVER**

Total Time:	120 min
-------------	---------

PREPARATION

PRE-LESSON INSTRUCTIONS

Resources needed for the delivery of this lesson are listed in the lesson specification located in A-CR-CCP-804/PG-001, *Proficiency Level Four Qualification Standard and Plan*, Chapter 4. Specific uses for said resources are identified throughout the instructional guide within the TP for which they are required.

Review the lesson content and become familiar with the material prior to delivering the lesson.

Photocopy the GPS receiver's Functions Image and the GPS receiver's Function Key Uses pages from the GPS manual for each cadet.

Photocopy the Waypoint Form located at Attachment A and cut it in two.

Mark off five specific waypoints. The waypoints should be at a physical object (eg, tree, fence post, street marker, telephone booth, etc.). Each waypoint should have a small container or plastic bag containing an object or written clue. The waypoint should be marked to indicate it is part of this lesson. The waypoints should be between 200–500 m apart.

Test and ensure the GPS receivers and hand-held radios are functional and have fully-charged batteries.

PRE-LESSON ASSIGNMENT

Nil.

APPROACH

A demonstration was chosen for TP 1 as it allows the instructor to demonstrate and explain how to navigate to a waypoint using a GPS receiver.

A practical activity was chosen for TP 2 as it allows the instructor to introduce the GPS receiver while providing an opportunity for the cadets to practice navigating to a waypoint using a GPS receiver under supervision.

INTRODUCTION

REVIEW

Nil.

OBJECTIVES

By the end of this lesson the cadet shall have navigated to a waypoint using a GPS receiver.

IMPORTANCE

It is important for cadets to experience navigating with a GPS receiver so that they have basic knowledge of how a GPS receiver works, enabling them to use a GPS in a survival situation. The skills learned in this lesson parallel the civilian sport of geocaching.

Teaching Point 1

Explain and demonstrate turning on the GPS receiver, selecting the waypoint list, selecting a waypoint, and using the GPS receiver to move to a waypoint.

Time: 30 min

Method: Demonstration



Due to the variety of available GPS receivers, the information in this TP should reflect the model used by the cadets.



Distribute a photocopy of the GPS receiver's Functions Image and GPS receiver's Function Key Uses and explanations to each cadet.

TURNING ON A GPS RECEIVER, SELECTING THE WAYPOINT LIST AND SELECTING A WAYPOINT

Follow the GPS manual for instructions on how to turn on, select a waypoint list and select a waypoint.



Demonstrate to the cadets how to turn on the GPS and select a waypoint.

USING THE GPS TO MOVE TO A WAYPOINT

Follow the GPS manual for instructions on how to move to a waypoint.



Have the cadets practice using the GPS receiver, to include:

- turning the unit on;
- selecting the waypoint list;
- selecting a waypoint; and
- moving to the waypoint.

CONFIRMATION OF TEACHING POINT 1

The cadets' participation in using the GPS receiver will serve as the confirmation of this TP.

Teaching Point 2

Have the cadets practice navigating to a waypoint using a GPS receiver.

Time: 80 min

Method: Practical Activity

ACTIVITY

OBJECTIVE

The objective of this activity is to have the cadets practice navigating to a waypoint using a GPS receiver.

RESOURCES

- GPS receiver,
- Waypoint containers,
- Waypoint locations,
- Hand-held radio (one per group),
- Waypoint Form located at Attachment A (one per group), and
- Pen / pencil.

ACTIVITY LAYOUT

Prepared waypoints as per pre-lesson instructions.

ACTIVITY INSTRUCTIONS

1. Divide the cadets into groups of four.
2. Distribute the equipment to the cadets.
3. Have the cadets perform a radio check.
4. Demonstrate to the cadets how to complete the Waypoint Form. A sample is located at Attachment B.



The waypoints may be indicated on the Waypoint Form as either the actual waypoint or the title of a waypoint that was previously entered into the GPS (eg. Lat / Lon, or Alpha Seven).

5. Have each cadet lead the group to one of the waypoints using the GPS receiver. It is possible that one or more cadets will lead to more than one waypoint.
6. Before moving to the next waypoint, have the cadets indicate the object or written clue on the Waypoint Form.
7. Have the cadets move through the five waypoints.
8. Gather the equipment.
9. Debrief the cadets on the activity.

SAFETY

- Each group will have a separate instructor during the navigation activity.
- Ensure cadets observe pedestrian safety during the navigation activity.

CONFIRMATION OF TEACHING POINT 2

The cadets' participation in the activity will serve as the confirmation of this TP.

END OF LESSON CONFIRMATION

The cadets' participation in navigating to a waypoint along a predetermined route using a GPS receiver will serve as the confirmation of this lesson.

CONCLUSION

HOMEWORK / READING / PRACTICE

Nil.

METHOD OF EVALUATION

This EO is assessed IAW A-CR-CCP-804/PG-001, *Proficiency Level Four Standard and Plan*, Chapter 3, Annex B, 490 PC.

CLOSING STATEMENT

The GPS receiver is a very powerful navigational tool which, like so many current technologies, continues to appear in other endeavours with a revolutionary effect. If a GPS is available in a survival situation, you can move effectively to safety or rescue.

INSTRUCTOR NOTES / REMARKS

Several waypoints should be set up before this lesson.

The waypoints should be indicated on the ground or object by a marker.

The waypoints should be 200 m–500 m apart.

Cadets who are qualified Survival Instructor may assist with this instruction.

REFERENCES

C2-143 ISBN 1-58923-145-7 Featherstone, S. (2004). *Outdoor guide to using your GPS*. Chanhassen, MN: Creative Publishing International, Inc.

THIS PAGE INTENTIONALLY LEFT BLANK

WAYPOINT FORM

TEAM		WAYPOINT	CLUE	START TIME	END TIME
NO					
1					
2					
3					
4					
5					

.....Cut Here.....

WAYPOINT FORM

TEAM		WAYPOINT	CLUE	START TIME	END TIME
NO					
1					
2					
3					
4					
5					

THIS PAGE INTENTIONALLY LEFT BLANK

EXAMPLE OF COMPLETED WAYPOINT FORM

WAYPOINT FORM

TEAM	WAYPOINT	CLUE	START TIME	END TIME
1	60° 40' 30" N 135° 08' 30" W	Purple plastic elephant	1400 hrs	1412 hrs
2	48° 19' 50" N 070° 59' 47" W	Grey plastic army man	1415 hrs	1424 hrs
3	54° 24' 18" N 110° 16' 46" W	The word yellow	1429 hrs	1437 hrs
4	44° 16' 18" N 079° 54' 43" W	Orange peel	1445 hrs	1455 hrs
5	44° 59' 04" N 064° 55' 01" W	Blue plastic airplane	1458 hrs	1505 hrs

THIS PAGE INTENTIONALLY LEFT BLANK



**ROYAL CANADIAN AIR CADETS
PROFICIENCY LEVEL FOUR
INSTRUCTIONAL GUIDE**



SECTION 5

EO M490.05 – LIGHT FIRES USING IMPROVISED IGNITION

Total Time:	120 min
-------------	---------

PREPARATION

PRE-LESSON INSTRUCTIONS

Resources needed for the delivery of this lesson are listed in the lesson specification located in A-CR-CCP-804/PG-001, *Proficiency Level Four Qualification Standard and Plan*, Chapter 4. Specific uses for said resources are identified throughout the instructional guide within the TP for which they are required.

Review the lesson content and become familiar with the material prior to delivering the lesson.

TPs 4 and 6 should be conducted on a sunny day.

For TPs 3–6, the cadets are only required to light the tinder.

PRE-LESSON ASSIGNMENT

Nil.

APPROACH

A demonstration was chosen for TPs 1 and 2 to allow the cadets to observe lighting a fire with a bow drill and a fire piston, and to stimulate interest in lighting fires using improvised ignition.

A demonstration and performance was chosen for TPs 3–6 as it allows the instructor to explain and demonstrate lighting fires with improvised ignition and permits the cadets to practice lighting fires under supervision.

INTRODUCTION

REVIEW

Nil.

OBJECTIVES

By the end of this lesson the cadet shall be expected to light fires using improvised ignition.

IMPORTANCE

It is important for cadets to light fires using improvised ignition to demonstrate the basics for achieving the ignition of tinder. This is a fundamental skill that will enable the cadet to be warm and dry in any survival situation. Practicing these skills will enable the cadet to demonstrate these techniques to other cadets at the squadron.

Teaching Point 1**Explain and demonstrate lighting a fire using a bow drill.**

Time: 15 min

Method: Demonstration

BOW DRILL

The bow drill is one of the oldest known methods of starting a fire.

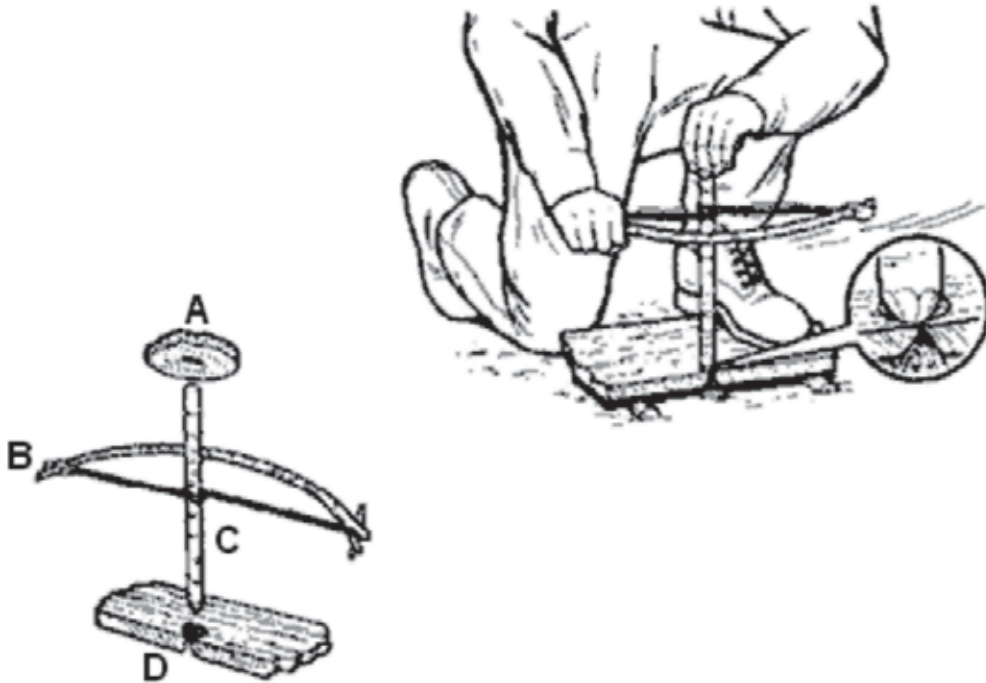

Figure 1 The Bow Drill

Note. From *U.S. Army Survival Handbook* (p. 132), by Department of the Army, 2002, Guilford, CT: The Lyons Press.

The parts of a bow drill are:

- A. The bearing block or handhold,
- B. The bow,
- C. The spindle or drill, and
- D. The hearth or fire board.

The spindle is held at one end by the bearing block and at the other by the hearth. The middle of the bow string is wrapped around the spindle one or more times. Moving the bow back and forth causes the spindle to spin. This spinning movement and pressure on the bearing block causes friction at the spindle hearth contact point.

The Bearing Block or Handhold

The bearing block can be made of anything that will protect the hand and apply pressure to the top of the spindle. Hardwood is easiest to procure, but bone, antler and stone work best as they can be easily lubricated, do not create as much friction, and do not burn. An indentation should be cut into the bottom of the block, matching the top of the spindle. The handhold can be lubricated with fat, grease, mud, soap or oil from the hair or face.

The Bow

The bow is constructed from a piece of wood and cordage. The bow string should be approximately 6 mm (1/4 inch) diameter cord. The bow should be approximately 60–75 cm (24–30 inches) long and have a curve

that measures 8–10 cm (3–4 inches) high when the ends are placed on a flat surface. The bow should be constructed from green wood or dry hardwood approximately the thickness of the thumb. Notches cut into the ends of the bow will help keep the bow string in place. A clove hitch should be used to fasten the cordage to the ends of the bow. The bow should maintain the proper tension on the bow string, allowing it to spin the spindle between the bearing block and the hearth. When using natural cordage, use less tension on the cord to prevent breakage.

The Spindle or Drill

The spindle is a piece of hard or softwood, about thumb thickness, usually 15–20 cm (6–8 inches) long. To create a properly shaped hole in the hearth, the spindle should be pointed on the bottom. To reduce friction at the top of the spindle, it should be chamfered (bevelled all around the edge) to a 45-degree angle.

The Hearth or Fire Board

The hearth is a rectangular piece of softwood, approximately 30 cm (12 inches) long, 6 cm (2 1/2 inches) wide and 1 cm (1/2 inch) thick. An indentation should be carved into the hearth, one spindle thickness in (from the edge), on the long edge of the hearth.

Using the Bow Drill

The position that a person assumes while operating the bow drill is as follows:

1. Place the right knee on the ground (assuming a right-handed operator) with the hearth located under the arch of the left foot, and the carved indentation to the right of the left foot.
2. Place the left wrist, holding the handhold, in front of the left shin to brace the hand and the handhold.
3. Hold the bow, with the cordage wrapped around the middle of the spindle, in the right hand. Place the spindle between the hearth and the handhold. Friction is achieved by pushing down on the handhold with the left hand and spinning the drill by pulling and pushing the bow with the right hand.

The hearth and spindle must be broken in before a glowing ember can be obtained. The heat of the friction between the hearth and the spindle creates charred dust. This dust will appear light brown at first. Continue spinning the spindle until the dust is dark brown. The spindle and indentation in the hearth now have matching profiles.

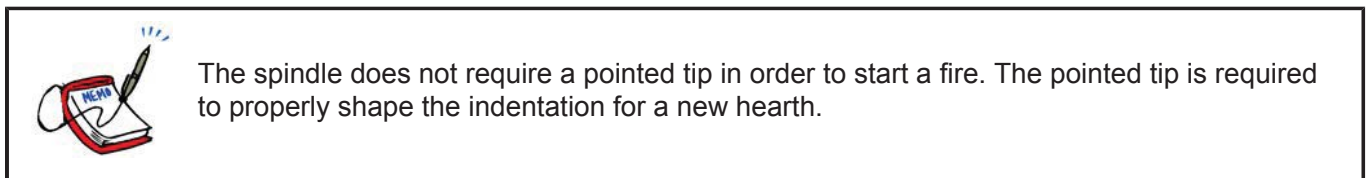

Cut a notch in the edge of the hearth perpendicular to the indentation created by the spindle. It should be wide enough to allow the dust to fall and collect in the notch. Place flat material under the notch to catch the dust and eventually the ember. Continue to spin the spindle with the bow and the dust will turn black and begin to smoke. Carefully watch for a glowing ember on the tinder. Carefully blowing on the ember will ignite the tinder.

CONFIRMATION OF TEACHING POINT 1

QUESTIONS:

- Q1. What are the four parts of a bow drill?
- Q2. What is the easiest material to find to use as a handhold?
- Q3. What is the usual position for using a bow drill?

ANTICIPATED ANSWERS:

A1. The four parts of a bow drill are:

- the bearing block or handhold,
- the bow,
- the spindle or drill, and
- the hearth or fire board.

A2. Hardwood.

A3. The usual position that a person assumes operating the bow drill is as follows:

1. Place the right knee on the ground (assuming a right-handed operator) with the hearth located under the arch of the left foot and the carved indentation to the right of the left foot.
2. Place the left wrist, holding the handhold, in front of the left shin to brace the hand and the handhold.
3. Hold the bow, with the cordage wrapped around the middle of the spindle, in the right hand. Place the spindle between the hearth and the handhold. Friction is achieved by pushing down on the handhold with the left hand and spinning the drill by pulling and pushing the bow with the right hand.

Teaching Point 2

Explain and demonstrate lighting a fire using a fire piston.

Time: 15 min

Method: Demonstration

FIRE PISTON

The fire piston is an ancient method of starting fires. It is believed to have originated in areas that developed blowguns in East Asia.

The fire piston is a unique method of producing fire. Fire pistons rely on the principle that compressing a volume of air raises its temperature. This is the same principle that is used in diesel engines. If air is compressed quickly enough, it can ignite tinder.

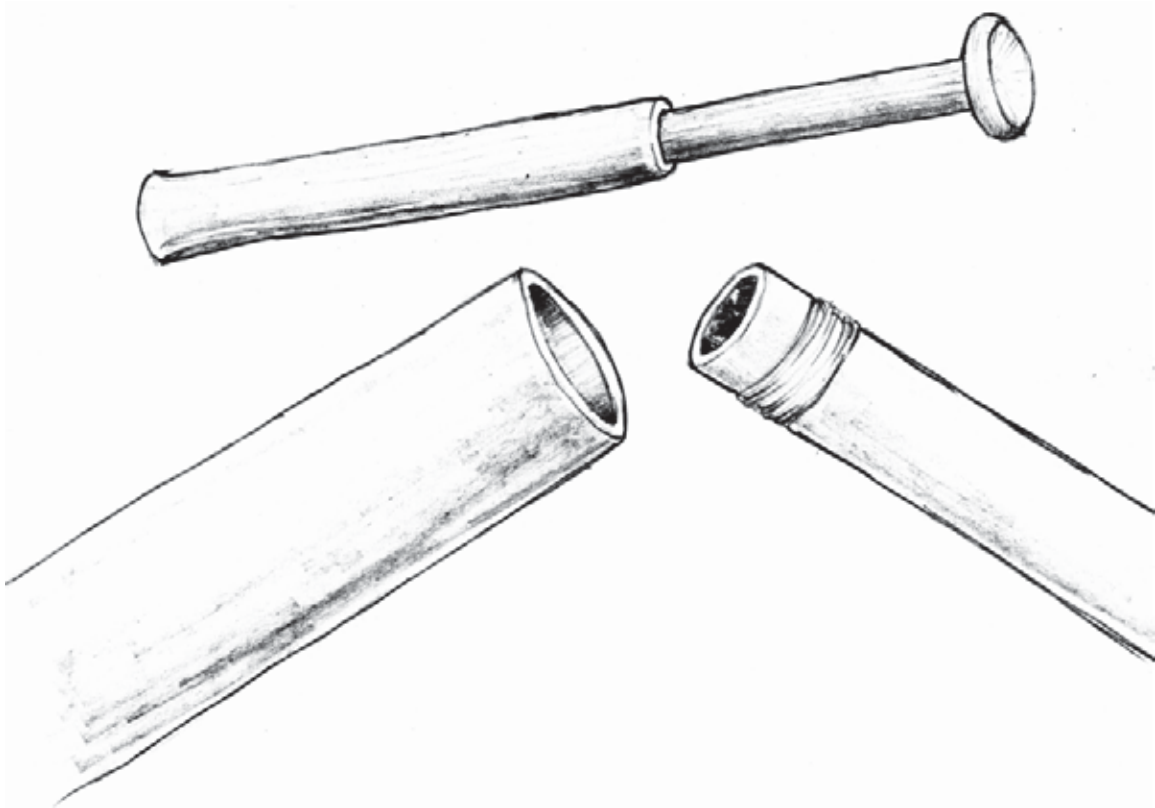

Figure 2 Fire Piston

Note. Created by Director Cadets 3, 2009, Ottawa, ON Department of National Defence.

A fire piston consists of a closed end cylinder and a plunger. The plunger should fit into the cylinder with an airtight seal. Tinder is placed into the cylinder (or in a hole on the end of the plunger) and the plunger is inserted a short way into the cylinder. The plunger is quickly forced down into the cylinder, compressing the air and raising its temperature, igniting the tinder and creating an ember. The movement is similar to smacking the plunger into the cylinder. The compressed air in the cylinder pushes the plunger outward. The plunger is quickly removed and the ember carefully removed and placed into a larger bundle of tinder and then blown into flame.

Traditionally, bamboo was used to construct fire pistons but they can be crafted from metal tubing salvaged from an aircraft or vehicle or carefully carved from hardwood.

CONFIRMATION OF TEACHING POINT 2

QUESTIONS:

- Q1. What principle does the fire piston use?
- Q2. What are the two main parts of a fire piston?
- Q3. From what material can fire pistons be crafted?

ANTICIPATED ANSWERS:

- A1. Fire pistons rely on the principle that compressing a volume of air raises its temperature.
- A2. The cylinder and plunger.
- A3. Traditionally, bamboo was used to construct fire pistons but they can be crafted from metal tubing salvaged from an aircraft or vehicle or carefully carved from hardwood.

Teaching Point 3

Explain, demonstrate and have the cadets light a fire using a magnesium fire starter.

Time: 20 min

Method: Demonstration and Performance



For this skill lesson, it is recommended that instruction take the following format:

1. Explain and demonstrate the complete skill while cadets observe.
2. Explain and demonstrate each step required to complete the skill. Monitor cadets as they imitate each step.
3. Monitor the cadets' performance as they practice the complete skill.

Note: Assistant instructors may be employed to monitor cadet performance.

Magnesium is a metal, that when powdered or shaved, will ignite from a spark. It burns at a very high temperature, making it an effective way to light a fire.

A magnesium fire starter consists of a piece of magnesium and a striking rod. Shaved off pieces of magnesium can be used with a rock or steel object to strike a spark onto the shavings.



Figure 3 Magnesium Fire Starter

Note. Created by Director Cadets 3, 2009, Ottawa, ON, Department of National Defence

The steps to use a magnesium fire starter are:

1. Prepare the area for the fire by assembling tinder and wood for the fire.
2. Place the bottom edge of the magnesium block on a small rock or piece of wood next to the tinder. The small rock or piece of wood will prevent the magnesium block from sinking into soft ground during the shaving process.
3. Using a knife blade, scrape the magnesium, making a small pile approximately the size of a quarter, at the base of the block.



The magnesium shavings are very light in weight. When experiencing high wind conditions, use your body or an object as a wind block and create a small depression where the block is resting on to catch the shavings.

4. Support the edge of the tool on the small rock or piece of wood approximately 25 cm (1 inch) from the pile of magnesium shavings. Using a piece of steel or a sharp rock, strike the sparking side of the magnesium

block. Position the magnesium block so the spray of sparks is directed onto the pile of magnesium shavings. This will ignite the magnesium shavings.



Always move the tinder to the magnesium. The burning magnesium is too hot to handle. Carefully place pieces of tinder on the pile of burning magnesium shavings.

ACTIVITY

Time: 5 min

OBJECTIVE

The objective of this activity is to have the cadets light a fire using a magnesium fire starter.

RESOURCES

- Magnesium fire starter,
- Knife,
- Tinder, and
- Pails of sand.

ACTIVITY LAYOUT

Nil.

ACTIVITY INSTRUCTIONS

1. Distribute the magnesium fire starters, knives, and tinder to each cadet.
2. Have each cadet scrape the magnesium block to produce a pile of shavings.
3. Have each cadet ignite the shavings and then add tinder to the burning magnesium.
4. After confirmation that the tinder has been lit, have the cadets extinguish the burning tinder using sand.
5. Gather the equipment.
6. Debrief the cadets on the activity.

SAFETY

Magnesium burns at a temperature of approximately 2200 degrees Celsius. The flames from burning magnesium seldom pass 30 cm in height. It will only burn as shavings or dust.

Burning magnesium is hard to extinguish as it can burn in nitrogen and carbon dioxide.

Under no circumstances should water be used to extinguish a magnesium fire.

A carbon dioxide (CO₂) fire extinguisher will not extinguish a magnesium fire.

Sand can be used to extinguish a magnesium fire.

CONFIRMATION OF TEACHING POINT 3

The cadets' participation in the activity will serve as the confirmation of this TP.

Teaching Point 4**Explain, demonstrate and have the cadets light a fire using an aluminium can and a bar of chocolate.**

Time: 20 min

Method: Demonstration and Performance



Dark tinted sunglasses will help alleviate eye strain and allow visual confirmation of the focal point.



For this skill lesson, it is recommended that instruction take the following format:

1. Explain and demonstrate the complete skill while cadets observe.
2. Explain and demonstrate each step required to complete the skill. Monitor cadets as they imitate each step.
3. Monitor the cadets' performance as they practice the complete skill.

Note: Assistant instructors may be employed to monitor cadet performance.

When the Sun's rays are focused, either through a lens or a concave reflector, they can generate enough heat to ignite tinder. The bottom of an aluminum can may have a concave shape suitable for focusing the Sun's rays. Polishing this concave shape with a compound will allow it to focus the Sun's rays. Possible polishing compounds can include:

- toothpaste,
- sink cleaner,
- chocolate, or
- very fine steel wool.

Toothpaste and sink cleaner have an aggressive grit and will polish the concave bottom quickly but will be less reflective. Chocolate has a fine grit and can take up to one hour to polish the concave bottom. The type of chocolate used can affect the time required to polish the bottom. Pure dark chocolate is best. Chocolate with nuts or raisins may take longer to polish the can. White chocolate usually does not have an abrasive quality. If more than one type of polish is available, start the process with the coarsest polishing compound and finish with the finest.



The aluminum particles removed from the can's bottom are considered harmful. They appear as a blackening of the polishing compound. Do not put any substance used in polishing in the mouth. Wash hands before eating. Do not eat the chocolate used to polish the can's bottom.



Figure 4 Polishing the Aluminum Can Bottom

Note. From "Fire from a can of coke and a chocolate bar", by W. Muma, 2003, *Wildwood Survival*, Copyright 2003 by W. Muma. Retrieved April 6, 2009, from <http://www.wildwoodsurvival.com/survival/cokecanandchocolatebar/index.html>

Polishing the Aluminium Can Base

Apply some polishing compound to a soft cloth. If using chocolate, the wrapper can be used as the polishing cloth. Polish the bottom of the can in a circular motion until the bottom has a mirror finish. The polishing will remove any evidence of printed information on the can's bottom. Embossed numbers or letters will not affect the can's ability to focus the Sun's rays.



Figure 5 Verifying the Polish

Note. From "Fire from a can of coke and a chocolate bar", by W. Muma, 2003, *Wildwood Survival*, Copyright 2003 by W. Muma. Retrieved April 6, 2009, from <http://www.wildwoodsurvival.com/survival/cokecanandchocolatebar/index.html>

The state of polish can be verified by examining the reflection of an object in the centre of the bottom of the can. Look for a clear reflection.

Igniting Tinder with the Focused Rays of the Sun

Several factors must be addressed when using this method. Full sun is required to use the can's polished bottom to ignite the tinder. The tinder must be very dry and sized to allow as much of the sun's rays as possible to enter the concave bottom of the can. The tinder must be centred at the focal point of the sun's rays. The can bottom and the tinder should be held still and close to the face to allow blowing on the tinder. Some types of tinder will smoke but will not ignite unless air is added. This is done by blowing gently on the tinder while the sun's rays are focused on it.



Figure 6 Large Ring of Light

Note. From "Fire from a can of coke and a chocolate bar", by W. Muma, 2003, *Wildwood Survival*, Copyright 2003 by W. Muma. Retrieved April 6, 2009, from <http://www.wildwoodsurvival.com/survival/cokecanandchocolatebar/index.html>



Figure 7 Medium Ring of Light

Note. From "Fire from a can of coke and a chocolate bar", by W. Muma, 2003, *Wildwood Survival*, Copyright 2003 by W. Muma. Retrieved April 6, 2009, from <http://www.wildwoodsurvival.com/survival/cokecanandchocolatebar/index.html>



Figure 8 Focused Spot of Light

Note. From "Fire from a can of coke and a chocolate bar", by W. Muma, 2003, *Wildwood Survival*, Copyright 2003 by W. Muma. Retrieved April 6, 2009, from <http://www.wildwoodsurvival.com/survival/cokecanandchocolatebar/index.html>



Figure 9 Using the Aluminum Can and Tinder

Note. From "Fire from a can of coke and a chocolate bar", by W. Muma, 2003, *Wildwood Survival*, Copyright 2003 by W. Muma. Retrieved April 6, 2009, from <http://www.wildwoodsurvival.com/survival/cokecanandchocolatebar/index.html>

The focal point of the Sun's rays passing through a convex lens or reflected by a concave reflector is the hottest point. This is where the tinder will ignite. To find the focal point, hold the can in one hand with the bottom pointed directly to the sun. The tinder can be placed on the end of a twig to avoid blocking the Sun's rays from the can's bottom.

To determine the best position for the can, hold the twig with the tinder so that the tinder is approximately three cm from the bottom of the centre of the can. Keep fingertips to the side of the can. The tinder can also be long and thin to avoid blocking sunlight (eg, birch bark, dry grass, slice of shelf mushroom).

Adjust the angle of the can by looking at the ring of light projected onto the underside of the tinder until the oval of sunlight becomes a circle. Sunglasses are recommended for this operation. Bring the tinder closer to or further from the bottom of the can until the circle of sunlight becomes the smallest dot possible. In a few moments, the tinder will start to smoke.

ACTIVITY

Time: 10 min

OBJECTIVE

The objective of this activity is to have the cadets light tinder using the polished concave bottom of an aluminum can and polishing compound.

RESOURCES

- Dark tinted sunglasses (one per cadet),
- Aluminum can (one per cadet),
- Chocolate,
- Toothpaste,
- Tinder, and
- Pails of sand.

ACTIVITY LAYOUT

Nil.

ACTIVITY INSTRUCTIONS



Polishing the bottom of the aluminum can with chocolate may take up to one hour. Toothpaste is preferred as a polish for this TP. If the cadets cannot finish in the allocated time, polishing of the aluminum can be done on their own time.

1. Distribute an aluminum can, piece of cloth and a dab of toothpaste to each cadet.
2. Have the cadets polish the bottom of the can with the polishing compound.
3. Wearing sunglasses, have the cadets practice establishing the focal point on the tinder.
4. After confirmation that the tinder has been lit, have the cadets extinguish all glowing / lit tinder using sand.
5. Gather the equipment.
6. Debrief the cadets on the activity.

SAFETY

A fire extinguisher and pails of sand shall be available at the site.

CONFIRMATION OF TEACHING POINT 4

The cadets' participation in the activity will serve as the confirmation of this TP.

Teaching Point 5

Explain, demonstrate and have the cadets light a fire using a battery, wire and steel wool.

Time: 20 min

Method: Demonstration and Performance

Like magnesium, steel is another metal that can burn when it is shaved or in powder form. Steel wool is made by shaving thin strands of iron off iron wire. It is used in wood and metal manufacturing as a mild abrasive and polish.



Figure 10 Using Batteries and Steel Wool

Note. From "Steel wool and a battery", 2003, *Practicalsurvivor.com*, Copyright 2003. Retrieved April 7, 2009, from <http://www.practicalsurvivor.com/node/32>



Figure 11 Battery and Steel Wool Ignition

Note. From "Steel wool and a battery", 2003, *Practicalsurvivor.com*, Copyright 2003. Retrieved April 7, 2009, from <http://www.practicalsurvivor.com/node/32>

When an electrical current passes through the strands of steel wool, the electrical resistance of the steel strands causes them to oxidize quickly enough to ignite and burn. The size and shape of the wool allows it to burn. Fine steel wool works best. Adding oxygen to the steel wool by blowing on it will increase the rate of oxidation, causing greater heat. Steel wool will burn when wet. The finer the grade of steel wool, the faster it will burn.

One battery (AA, C and D cell) does not have enough voltage and amperage to ignite the steel wool by itself. Two batteries (AA, C and D cell), a nine volt battery, cell phone or radio battery will ignite the steel wool but this will drain the batteries quickly. This use of batteries should be evaluated carefully as the batteries may be more useful in an object like a GPS, cell phone or radio.

To use steel wool and batteries:

1. Pull the steel wool into a multi-strand bundle long enough to reach both battery terminals.
2. Prepare tinder where the fire will be lit.
3. Place one end of the bundle on one terminal of the batteries.
4. Place the other end of the bundle on the opposite battery terminal.

The bundle of steel wool will ignite immediately and can be added to the tinder.

Steel wool can also be ignited by a spark from flint (hard rock) and steel, the flint of a empty lighter or any other source of spark.

ACTIVITY

Time: 10 min

The objective of this activity is to have the cadets light a fire using a battery and steel wool.

RESOURCES

- AA batteries (two per cadet),
- Tinder,
- Pails of sand, and
- Steel wool.

ACTIVITY LAYOUT

Nil.

ACTIVITY INSTRUCTIONS

1. Distribute the batteries, steel wool and tinder to the cadets.
2. Have the cadets crouch down to the ground and ignite the steel wool with the batteries.
3. Have the cadet place the tinder on the burning steel wool and blow gently on it to ignite the tinder.
4. After confirmation that the tinder is lit, have the cadets extinguish the tinder using sand.
5. Gather the equipment.
6. Debrief the cadets on the activity.

SAFETY

A fire extinguisher and pails of sand shall be available at the site.

CONFIRMATION OF TEACHING POINT 5

The cadets' participation in the activity will serve as the confirmation of this TP.

Teaching Point 6

Explain, demonstrate and have the cadets light a fire using a magnifying lens.

Time: 20 min

Method: Demonstration and Performance

A magnifying lens will accomplish the same objective as the bottom of the aluminum can. It will focus the sun's rays into one point that will ignite tinder. It can be made of glass, plastic, ice or water.

Glass or plastic lenses can be obtained from:

- a magnifying glass,
- binoculars,

- a camera, or
- eyeglasses.

The type of tinder will dictate how much effort will be required to ignite it. Average tinder and a small lens will require additional air to ignite.



Figure 12 Using Binoculars to Ignite Tinder

Note. From "Magnifying lens", by W. Muma, 2003, *Wildwood Survival*, Copyright 2003 by W. Muma. Retrieved April 6, 2009, from <http://www.wildwoodsurvival.com/survival/fire/magnifier.html>

Larger and thicker lenses will generate higher temperatures at the focal point but the point may be too far from the lens to be effective. Most eyeglasses will prove difficult to use lighting fires as they do not have the magnification necessary to ignite tinder. Experimentation is necessary to find the focal point of a lens or set of lenses. Before disassembling an object containing lenses, evaluate its worth during the survival situation.

Fire From Ice



Figure 13 Rough Carved Sphere of Ice

Note. From "Fire from ice", by W. Muma, 2003, *Wildwood Survival*, Copyright 2003 by W. Muma. Retrieved April 6, 2009, from <http://www.wildwoodsurvival.com/survival/fire/ice/rb/rbfirefromice4b.html>



Figure 14 Polishing a Sphere of Ice

Note. From "Fire from ice", by W. Muma, 2003, *Wildwood Survival*, Copyright 2003 by W. Muma. Retrieved April 6, 2009, from <http://www.wildwoodsurvival.com/survival/fire/ice/rb/rbfirefromice4b.html>



Figure 15 Using a Piece of Tubing to Shape an Ice Sphere

Note. From "Fire from ice", by W. Muma, 2003, *Wildwood Survival*, Copyright 2003 by W. Muma. Retrieved April 6, 2009, from <http://www.wildwoodsurvival.com/survival/fire/ice/rb/rbfirefromice4b.html>



Figure 16 Igniting Tinder with an Ice Sphere

Note. From "Fire from ice", by W. Muma, 2003, *Wildwood Survival*, Copyright 2003 by W. Muma. Retrieved April 6, 2009, from <http://www.wildwoodsurvival.com/survival/fire/ice/rb/rbfirefromice4b.html>

Spherical ice lenses can be made in cold climates. A sphere of ice used as a lens will give a usable focal point that can be used to ignite tinder. Ice from a lake or shore of a river that is free of air bubbles and crystal clear is necessary for this method of fire lighting. The sphere should be larger than 4 cm (1 1/2 inches) to be effective.

To make a spherical lens of ice:

1. Start by cutting the rough shape from a larger block of ice.
2. Once the spherical shape has been established, turn the sphere in bare hands to smooth and polish the surface. If a metal tube is available (eg. aircraft exhaust or spar tubing) spinning the sphere on the end of the tube will shave it almost perfectly round. The tubing must be slightly smaller in diameter than the ice sphere.
3. The sphere can be held by wrapping a strip of cloth or bootlace around its circumference and twisting it tight.

Fire From Water



Figure 17 Igniting Tinder with Plastic Wrap and Water

Note. From "Fire from ice", by W. Muma, 2003, *Wildwood Survival*, Copyright 2003 by W. Muma. Retrieved April 6, 2009, from <http://www.wildwoodsurvival.com/survival/fire/ice/rb/rbfirefromice4b.html>

A clear piece of plastic wrap, balloon or condom can also be used if partially filled with water. The object is to make a perfect sphere by twisting the open end tight so the plastic takes a spherical shape. The Sun's rays can then be focused on the tinder.

1. Place some water in the plastic. The sphere should be larger than 4 cm (1 1/2 inches) to be effective.
2. Twist the opening tightly to form a sphere.

3. Hold the sphere between the tinder and the sun.
4. Locate the focal point and ignite the tinder.



Figure 18 Igniting Tinder with a Broken Light Bulb and Water

Note. From "Fire from ice", by W. Muma, 2003, *Wildwood Survival*, Copyright 2003 by W. Muma.
Retrieved April 6, 2009, from <http://www.wildwoodsurvival.com/survival/fire/ice/rb/rbfirefromice4b.html>

A piece of broken light bulb, wine glass or any other round clear object holding some water can also be used to focus the Sun's rays.

ACTIVITY

Time: 10 min

OBJECTIVE

The objective of this activity is to have the cadets ignite tinder using a magnifying lens.

RESOURCES

- Magnifying lens,
- Clear plastic bag,
- Water,
- Tinder, and
- Pails of sand.

ACTIVITY LAYOUT

Nil.

ACTIVITY INSTRUCTIONS

1. Have the cadet select a method of ignition from:
 - a. magnifying lens, or
 - b. clear plastic bag.
2. Distribute lens or clear plastic bag and water and tinder to the cadets.
3. Have the cadets ignite the tinder with the selected lens.
4. After confirmation that the tinder is lit, extinguish the tinder using sand.
5. Gather the equipment.
6. Debrief the cadets on the activity.

SAFETY

A fire extinguisher and pails of sand shall be available at the site.

CONFIRMATION OF TEACHING POINT 6

The cadets' participation in the activity will serve as the confirmation of this TP.

END OF LESSON CONFIRMATION

The cadets' participation in the activities will serve as the confirmation of this lesson.

CONCLUSION

HOMEWORK / READING / PRACTICE

Nil.

METHOD OF EVALUATION

This EO is assessed IAW A-CR-CCP-804/PG-001, *Proficiency Level Four Standard and Plan*, Chapter 3, Annex B, 490 PC.

CLOSING STATEMENT

There are many methods for igniting tinder in a survival situation. The ones demonstrated in this lesson should be practiced often. The heat and warmth of a fire can be a necessity in a survival situation.

INSTRUCTOR NOTES / REMARKS

Petroleum products such as gasoline should be handled with care due to its combustible properties. Avoid skin contact. Refer to Material Safety Data Sheet (MSDS).

Cadets who are qualified Survival Instructor may assist with this instruction.

REFERENCES

C3-002 ISBN 0-00-653140-7 Wiseman, J. (1999). *The SAS survival handbook*. Hammersmith, London: HarperCollins Publishers.

C3-003 ISBN 1-896713-00-9 Tawrell, P. (1996). *Camping and wilderness survival: The ultimate outdoors book*. Green Valley, ON: Author.

C3-314 Wildwood Survival. (2009). *Fire from a can of coke and a chocolate bar*. Retrieved February 9, 2009, from <http://www.wildwoodsurvival.com/survival/fire/cokeandchocolatebar/index.html>

C3-315 Primitive Ways. (1996). *The fire piston: Ancient firemaking machine*. Retrieved February 9, 2009, from http://www.primitiveways.com/fire_piston.html



ROYAL CANADIAN AIR CADETS
PROFICIENCY LEVEL FOUR
INSTRUCTIONAL GUIDE



SECTION 6

EO C490.01 – DESCRIBE CLIMATIC AND SEASONAL CONCERNS

Total Time: 30 min

PREPARATION

PRE-LESSON INSTRUCTIONS

Resources needed for the delivery of this lesson are listed in the lesson specification located in A-CR-CCP-804/PG-001, *Proficiency Level Four Qualification Standard and Plan*, Chapter 4. Specific uses for said resources are identified throughout the instructional guide within the TP for which they are required.

Review the lesson content and become familiar with the material prior to delivering the lesson.

PRE-LESSON ASSIGNMENT

Nil.

APPROACH

An interactive lecture was chosen for TP 1 to give an overview of climate concerns.

A group discussion was chosen for TP 2 as it allows the cadets to interact with their peers and share knowledge, experiences, opinions, and feelings about seasonal concerns associated with spring, summer, autumn, and winter weather. This helps develop rapport by allowing the instructor to evaluate the cadets' responses in a non-threatening way while helping them refine their ideas. A group discussion also helps the cadets improve their listening skills and develop as members of a team.

INTRODUCTION

REVIEW

Nil.

OBJECTIVES

By the end of this lesson the cadet shall have described climatic and seasonal factors that affect survival situations.

IMPORTANCE

It is important for cadets to describe seasonal concerns, so they can apply the knowledge in a survival situation.

Teaching Point 1**Describe climate associated with regions and climate change.**

Time: 15 min

Method: Interactive Lecture

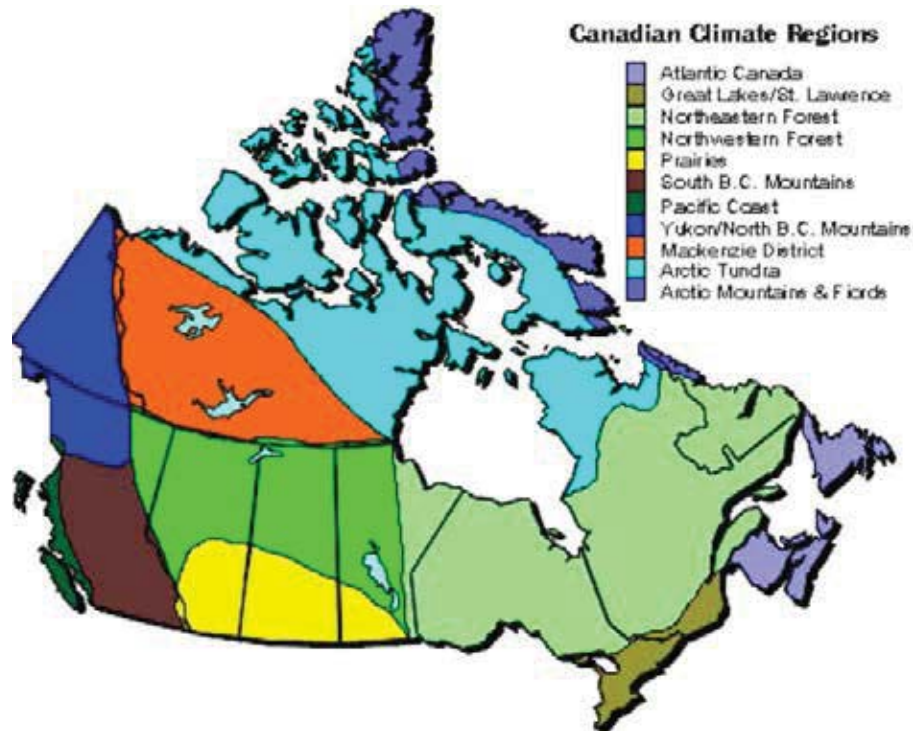

Figure 1 Climate Map

Note. From *Canadian Regional Climates*, 2002, by Environment Canada. Retrieved April 17, 2009, from http://www.msc-smc.ec.gc.ca/ccrm/bulletin/figclimate_e.html

It is important to understand each regional climate zone. If an individual is lost or in a survival situation, it is good to know the climate of the region they are surviving in. Canada has 11 regional climates (as illustrated in Figure 1).

CANADIAN REGIONAL CLIMATE**The West Coast**

British Columbia's coast has the most temperate climate in Canada. It rarely snows in the low-lying areas of the coastal range and the Rocky Mountains block the Pacific air from the Prairies. The valleys between the mountain ranges experience hot summers, almost completely precipitation free.

The Prairies

The Prairies extend east of the Rocky Mountains to the Great Lakes. The Prairies has predominant climate, with the cold winters and humid, hot summers.

The Great Lakes–St. Lawrence

More than half of the population of Canada lives here. The winters have a lot of snowfall and wind and the summers are humid and longer than anywhere else in Canada.

Atlantic Canada

It has one of the most rugged and variable climates in Canada. In the winter, temperatures can vary as the arctic air is replaced by maritime air from passing storm systems. The snowfall is heavy and fog is often present in the spring and at the beginning of summer. The warmest time of the year is in July, as temperatures average 16–18 degrees Celsius.

The North

The North is mostly covered in snow during the year. The summer lasts for two months and the temperatures rise above freezing for only a few weeks of the year. The temperatures are so cold that the ground is frozen all year long.

CLIMATE CHANGE

Environmental Impact

Canada's climate has increased by 1.3 degrees Celsius since 1948, with the Arctic experiencing the greatest changes of all regions. The warming in the Arctic has led to a decrease in snow cover and sea ice, a degradation of permafrost, and a retreat of glaciers and ice caps. To the south of the Arctic, the winter snow is melting earlier and glaciers are disappearing.

The water levels of the Great Lakes are dropping and sea levels are rising. The temperature increase is causing a longer growing season for plant vegetation.

The climate change is causing increases in related hazards, such as heat waves, droughts, floods, forest fires, storm surges, and coastal erosion. These hazards are not only costly (damage to property and infrastructure) but can be life threatening if climate change increases significantly.

A warming climate in Canada impacts water quantity and quality across the country. Frequent downpours in the Great Lakes could lead to localized flooding and overwhelm current sewage treatment facilities with increases in sewage and stormwater runoff.

The Prairies may see a decline in water levels on ponds, lakes and dugouts, leading to changes in water chemistry, which means less water for crop irrigation.

Health Impact

The health and well-being of Canadians could be affected by the climate change. Some of the health impacts are related to:

- an increasing number of smog and extreme heat events,
- the spread of infectious diseases from insects migrating northward, and
- a decline in the quality and the quantity of drinking water in some areas because of drought.

The health impact varies from one location to another and changes over time, as temperatures and other climatic conditions continue to change.

CONFIRMATION OF TEACHING POINT 1

QUESTIONS:

- Q1. How many regional climate zones are there in Canada?
- Q2. What are the health impacts related to the climate change in Canada?
- Q3. How does a changing climate impact health?

ANTICIPATED ANSWERS:

- A1. There are 11 regional climate zones in Canada.
- A2. The health impacts related to climate change in Canada are:
- an increasing number of smog and extreme heat events,
 - the spread of infectious diseases from insect migrating northward, and
 - a decline in the quality and the quantity of drinking water in some areas because of drought.
- A3. The health impact changes from one location to another and over time, as temperatures and other climatic conditions continue to change.

Teaching Point 2

Conduct a group discussion on seasonal concerns in a survival situation.

Time: 10 min

Method: Group Discussion

BACKGROUND KNOWLEDGE



The point of the group discussion is to draw the following information from the group using the tips for answering / facilitating discussion and the suggested questions provided.

There are four seasons in Canada: spring, summer, autumn and winter.

The following are typical features of seasons in the southern part of Canada:

Spring

The season starts in March and ends in May. During this period, the snow begins to melt. It is known to be the rainy season in most parts of Canada. The days become warmer, but the nights are still cool. Vegetation starts growing; however, trees remain bare until April or May.

Summer

The season starts in June and ends in August, though in some parts of Canada the season can last until mid-September. The temperatures in summer may reach 30 degrees Celsius or higher. The season is known to be typically hot and dry with occasional rainstorms / thunderstorms. Humidity is a factor around the Great Lakes region. This is the season of mosquitoes and blackflies.

Autumn

The season starts in September and ends in November with days becoming shorter. As the days become shorter, temperatures start to fall, and during the night, frost starts to appear. The vegetation starts to die off and leaves start to change colour. During this season, weather is unpredictable with rain and the first signs of snow usually appear in November.

Winter

The season starts in December and ends in February, sometimes later in some regions of Canada. This season is known for snow and ice. Snow can start as early as October and continue to late March. The temperatures are below zero degrees Celsius from December to mid-March, especially at night. The wind is a factor as well and wind chill can make it feel even colder. The only parts of Canada where temperatures appear to be milder are on the East and West Coasts, where there is more precipitation.

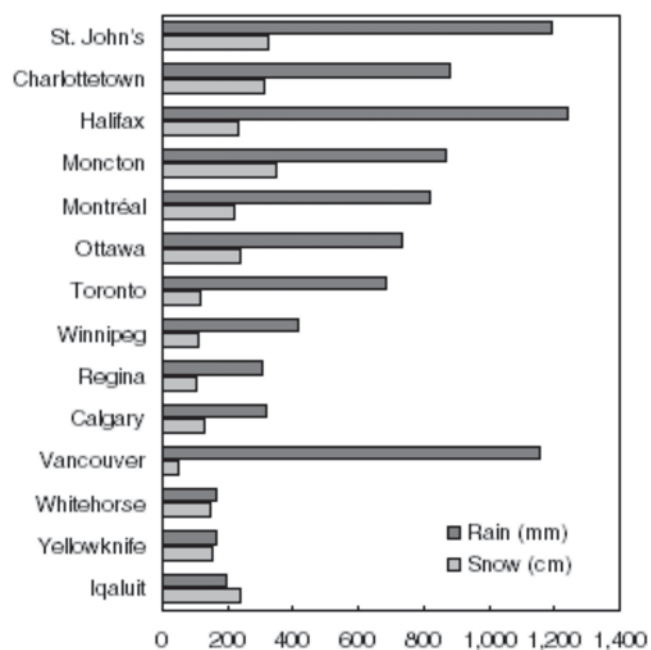

Figure 2 Annual Average Precipitation (1971 to 2000)

Note. From *Canadian Climate Normals*, by Environment Canada (2004). Retrieved April 22, 2009, from http://www.climate.weatheroffice.ec.gc.ca/climate_normals/index_e.html

GROUP DISCUSSION



TIPS FOR ANSWERING / FACILITATING DISCUSSION:

- Establish ground rules for discussion, eg, everyone should listen respectfully; don't interrupt; only one person speaks at a time; no one's ideas should be made fun of; you can disagree with ideas but not with the person; try to understand others as much as you hope they understand you; etc.
- Sit the group in a circle, making sure all cadets can be seen by everyone else.
- Ask questions that will provoke thought; in other words avoid questions with yes or no answers.
- Manage time by ensuring the cadets stay on topic.
- Listen and respond in a way that indicates you have heard and understood the cadet. This can be done by paraphrasing their ideas.
- Give the cadets time to respond to your questions.
- Ensure every cadet has an opportunity to participate. One option is to go around the group and have each cadet answer the question with a short answer. Cadets must also have the option to pass if they wish.
- Additional questions should be prepared ahead of time.

SUGGESTED QUESTIONS:

- Q1. How do the seasonal concerns in the spring affect an individual in a survival situation?
- Q2. How do the seasonal concerns in the summer affect an individual in a survival situation?
- Q3. How do the seasonal concerns in autumn affect an individual in a survival situation?
- Q4. How do the seasonal concerns in the winter affect an individual in a survival situation?



Other questions and answers will develop throughout the group discussion. The group discussion should not be limited to only those suggested.



Reinforce those answers given and comments made during the group discussion, ensuring the teaching point has been covered.

CONFIRMATION OF TEACHING POINT 2

The cadets' participation in the group discussion will serve as the confirmation of this TP.

END OF LESSON CONFIRMATION

The cadets' participation in the group discussion will serve as the confirmation of this lesson.

CONCLUSION

HOMEWORK / READING / PRACTICE

Nil.

METHOD OF EVALUATION

Nil.

CLOSING STATEMENT

It is important to describe climatic and seasonal concerns so you can apply the knowledge when in a survival situation.

INSTRUCTOR NOTES / REMARKS

Cadets who are qualified Survival Instructor may assist with this instruction.

REFERENCES

C3-341 Environment Canada.(2009). *Environmental impacts*. Retrieved April 16, 2009, from <http://www.ec.gc.ca/cc/default.asp?lang=En&n=4630D154-1>

C3-342 Environment Canada. (2009). *Health impacts*. Retrieved April 16, 2009, from <http://www.ec.gc.ca/cc/default.asp?lang=En&n=0B072979-1>

C3-343 O Canada. (2009). *Canadian regional climate*. Retrieved April 16, 2009, from <http://www.ocanada.ca/climate/regional.php>

C3-344 Government of Canada. (2008). *Four seasons*. Retrieved April 22, 2009, from <http://www.goingtocanada.gc.ca/CIC/display-afficher.do?id=000000000039&lang=eng>

THIS PAGE INTENTIONALLY LEFT BLANK



ROYAL CANADIAN AIR CADETS
PROFICIENCY LEVEL FOUR
INSTRUCTIONAL GUIDE



SECTION 7

EO C490.02 – IMPROVISE TOOLS FOR USE IN A SURVIVAL SITUATION

Total Time: 60 min

PREPARATION

PRE-LESSON INSTRUCTIONS

Resources needed for the delivery of this lesson are listed in the lesson specification located in A-CR-CCP-804/PG-001, *Proficiency Level Four Qualification Standard and Plan*, Chapter 4. Specific uses for said resources are identified throughout the instructional guide within the TP for which they are required.

Review the lesson content and become familiar with the material prior to delivering the lesson.

The following examples of improvised tools should be constructed before this lesson:

- a knife,
- a needle,
- a compass, and
- a hammer.

PRE-LESSON ASSIGNMENT

Nil.

APPROACH

A group discussion was chosen for TP 1 to allow the cadets to interact with their peers and share knowledge and experiences about the potential of the materials at hand during a survival situation.

A demonstration and performance was chosen for TPs 2 and 3 as it allows the instructor to explain and demonstrate the skill of improvising tools while providing an opportunity for the cadets to practice the skill under supervision

A demonstration was chosen for TP 4 as it allows the cadets to observe how to construct a hammer.

INTRODUCTION

REVIEW

Nil.

OBJECTIVES

By the end of this lesson the cadet shall be expected to improvise tools for use in a survival situation.

IMPORTANCE

It is important for cadets to improvise tools for use in a survival situation as this skill enables the cadet to adapt to most survival situations. These skills give the survivor purpose and help build morale and spirit.

Teaching Point 1**Discuss the potential of the materials at hand for use in a survival situation.**

Time: 10 min

Method: Group Discussion

BACKGROUND KNOWLEDGE



The point of the group discussion is to draw the following information from the group using the tips for answering / facilitating discussion and the suggested questions provided.

A survival situation demands improvisation depending on what tools are available. Even simple tools can have multiple uses. If tools are not available, the surrounding area should be surveyed for possibilities.

Safety is paramount when using any tool or item as a tool. Injuries incurred during a survival situation deplete precious resources and energy and can be demoralizing to the survivor or survivors.

Using what is available should be one of the first things considered for all survival situations.

Usable items may be procured from the environment, vehicles, and buildings.

Vehicles, including cars, bicycles, trucks, heavy machinery, boats, snowmobiles and motorcycles offer some of the same items found on aircraft. Vehicles and buildings may be used as shelter.

Some suggested items that can be used from vehicles are:

- wires,
- mirrors,
- hubcaps,
- control cables,
- leatherette seat covers, and
- antennae.

Some suggested items that can be used from buildings are:

- wires,
- wood,
- glass,
- plastic, and
- various metal and plastic pipes and tubing.

Primitive man has survived in almost all environments on the planet. He has made use of the materials available.

Some suggested items that can be used from the surrounding environment are:

- trees,
- grasses and plants,
- stones,
- dirt,
- sand, and
- animal parts, to include:
 - fat,
 - skin,
 - organs,
 - bones, and
 - sinew.

GROUP DISCUSSION



TIPS FOR ANSWERING / FACILITATING DISCUSSION:

- Establish ground rules for discussion, eg, everyone should listen respectfully; don't interrupt; only one person speaks at a time; no one's ideas should be made fun of; you can disagree with ideas but not with the person; try to understand others as much as you hope they understand you; etc.
- Sit the group in a circle, making sure all cadets can be seen by everyone else.
- Ask questions that will provoke thought; in other words avoid questions with yes or no answers.
- Manage time by ensuring the cadets stay on topic.
- Listen and respond in a way that indicates you have heard and understood the cadet. This can be done by paraphrasing their ideas.
- Give the cadets time to respond to your questions.
- Ensure every cadet has an opportunity to participate. One option is to go around the group and have each cadet answer the question with a short answer. Cadets must also have the option to pass if they wish.
- Additional questions should be prepared ahead of time.

SUGGESTED QUESTIONS:

- Q1. Why is safety important when using tools in a survival situation?
- Q2. What are some items that can be taken from vehicles?

Q3. What are some items that can be taken from buildings?

Q4. What are some items that can be taken from the surrounding environment?



Other questions and answers will develop throughout the group discussion. The group discussion should not be limited to only those suggested.



Reinforce those answers given and comments made during the group discussion, ensuring the teaching point has been covered.

CONFIRMATION OF TEACHING POINT 1

The cadets' participation in the group discussion will serve as the confirmation of this TP.

Teaching Point 2

Explain, demonstrate and have the cadets construct a cutting or piercing tool.

Time: 15 min

Method: Demonstration and Performance



For this TP, it is recommended that instruction take the following format:

1. Explain and demonstrate the complete skill while cadets observe.
2. Explain and demonstrate each step required to complete the skill. Monitor cadets as they imitate each step.
3. Monitor the cadets' performance as they practice the complete skill.

Note: Assistant instructors may be employed to monitor the cadets' performance.

Cutting and piercing tools can make everyday life in a survival situation easier. They are used to prepare food, assemble shelter and create other tools.

Most purchased cutting and piercing tools are made of stainless or tool steel. Even if these materials are available, they are difficult to work without a forge, machine shop or special metal working tools. Therefore, softer materials like aluminum, bone or plastic should be considered.

A safety razor contains one or more thin blades. These are removed by disassembling the razor's head. Although small and thin, these blades are extremely sharp. The opposite edge should be covered with tape or mounted in wood.

Stone may be shaped into cutting tools, but the technique, called flint knapping, is difficult to master. The sharp edge of broken stones may be used as a cutting tool. Smashing two stones together may leave sharp fragments that will serve as a cutting tool. Use caution when breaking stones as sharp fragments will fly off the broken stone, potentially causing injury.

Broken glass can be used but is brittle and difficult to use without inflicting wounds on the user. A piece of broken glass has cutting edges on all sides. Covering the opposite edge of the tool with thick tape or in a grooved stick may prevent injury. Glass is very fragile and will not endure hard use as a cutting tool.

Bone, metal or plastic can be used to fashion cutting or piercing tools but the edge or point will not remain sharp. Adding small teeth to the edge of a cutting tool will help during cutting. Aluminum and other soft metal cutting edges can be formed by pounding the edge between two stones. The edge of a cutting tool and size of the blade should not exceed 10 cm. Longer edges become unwieldy in use.

Bone can be fashioned into a sewing needle. Strike the bone with a stone to create splinters. These splinters can be smoothed and shaped by rubbing on a stone. To pierce a hole for the eye of the needle, a sharp chip of stone can be set and bound in a split stick and spun between the hands to create a drill.

Handle material can be wood, with wire, strong material (seat cover, or leather) or cord wrapping. The handle should be comfortable in the hand and securely fastened to the blade.

When not being used, a protective cover can be fashioned from strong material to protect the knife and user.

CONFIRMATION OF TEACHING POINT 2

The cadets' construction of a cutting / piercing tool will serve as the confirmation of this TP.

Teaching Point 3

Explain, demonstrate and have the cadets construct a compass.

Time: 15 min

Method: Demonstration and Performance



For this skill lesson, it is recommended that instruction take the following format:

1. Explain and demonstrate the complete skill while cadets observe.
2. Explain and demonstrate each step required to complete the skill. Monitor cadets as they imitate each step.
3. Monitor the cadets' performance as they practice the complete skill.

Note: Assistant instructors may be employed to monitor the cadets' performance.

A compass needle points north because the needle is magnetized and becomes aligned by the earth's magnetic field. An improvised compass can be created from a small strip of ferrous metal and a container of water.

To magnetize the ferrous metal several methods may be employed. A sewing needle is an excellent piece of ferrous metal to magnetize as it is light in weight and easily magnetized.

Method 1:

Stroke a piece of silk fabric repeatedly in one direction (from the eye end to the point).

Method 2:

Stroke a magnet in one direction along the length of the needle (from the eye end to the point) repeatedly.

Method 3:

Heat the needle red hot and allow it to cool in an approximate north-south direction will. Use caution, as moving the red hot needle around to align it may prove difficult and dangerous in a survival situation.

Constructing the Compass

Once magnetized, the needle needs to be able to pivot freely to locate north.

There are several ways to allow the needle to pivot freely. One method is to float the needle on a liquid. If the needle floats on a liquid such as water it can rotate. A buoyant object (eg, cork, leaf, Styrofoam, plastic cling wrap, etc.) can be used to support the needle on the surface of the water. Surface tension supports a small needle, but any disturbance to the container and the needle will sink.

Another method of allowing the needle to rotate is to attach it to a fine string, cord, long strand of hair, fishing line or other fine cordage. The cordage is attached exactly in the middle of the needle to keep it horizontal. The needle points north when allowed to dangle at the bottom of the cordage. North is found by slowly turning the cordage left or right and observing when the needle is rotating the least. This method proves difficult in windy conditions.

To verify which end of the needle is pointing north, use basic navigational skills (eg, North Star, Sun's position during the day, etc.).

ACTIVITY

Time: 5 min

OBJECTIVE

The objective of this activity is to have the cadets a construct compass.

RESOURCES

- sewing needle,
- silk cloth, and
- small magnet.

ACTIVITY LAYOUT

Nil.

ACTIVITY INSTRUCTIONS

Have the cadets:

1. select a method of magnetizing the needle;
2. magnetize the needle;
3. select a method for allowing the needle to pivot;
4. determine north with the constructed compass; and
5. discuss the process of making a compass.



Cadets using the liquid method should improvise the float and container of water. Cadets using the cordage method should improvise the cordage.

SAFETY

Nil.

CONFIRMATION OF TEACHING POINT 3

The cadets' construction of an improvised compass will serve as the confirmation of this TP.

Teaching Point 4**Explain and demonstrate how to construct a hammer.**

Time: 10 min

Method: Demonstration

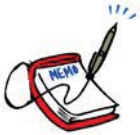

Using the hammer constructed prior to this lesson, explain and demonstrate how the hammer was made.

A hammer is one of the most basic and fundamental tools. It is perhaps the oldest human tool known. The earliest evidence of stone used as a hammer dates to about 2.4 million years ago. 30 000 years ago, humans adapted handles to stones to create hammers.

A stone can be used as a hammer for driving sticks into the ground, dispatching fish and small animals. If unhandled, the stone fits comfortably in the hand, with the finger tips extending just past the midpoint of the stone. Using smaller stones risks smashing fingers.

To make a split stick hammer, use the following steps:

1. Wrap the handle 15–20 cm from end with cordage.
2. Split the handle to the wrap.
3. Open tines and insert the stone hammer head.
4. Securely lash the stone to the handle.
5. Pull tines together at the top of the stone head and lash securely.

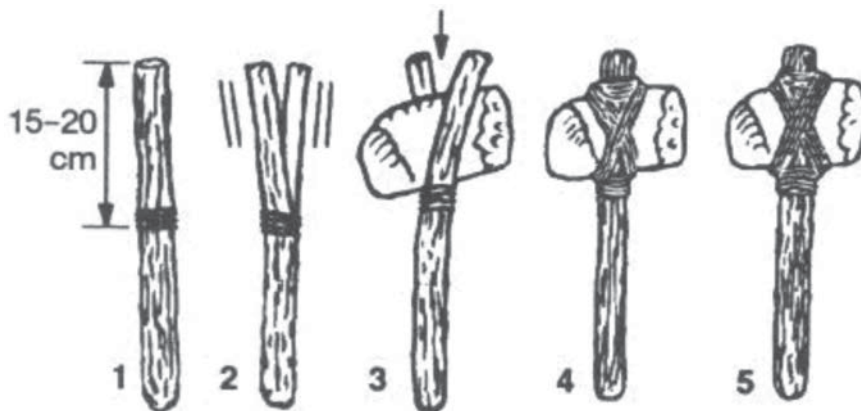

Figure 1 Split Stick Hammer

Note. From *U.S. Army Survival Handbook* (p. 134), by Department of the Army, 2002, Guilford, CT: The Lyons Press.

To make a forked stick hammer:

1. Find a suitable green wood forked branch and trim it to the correct length. Leave the tines long enough to be lashed above the stone.
2. Lash the base of the fork in the stick to prevent it from splitting when the tines are attached above the stone. A groove in the stone will help keep it from moving in use.
3. Set the stone in the crotch of the forked stick and start pulling the tines together with cordage. Secure the tines with cordage.

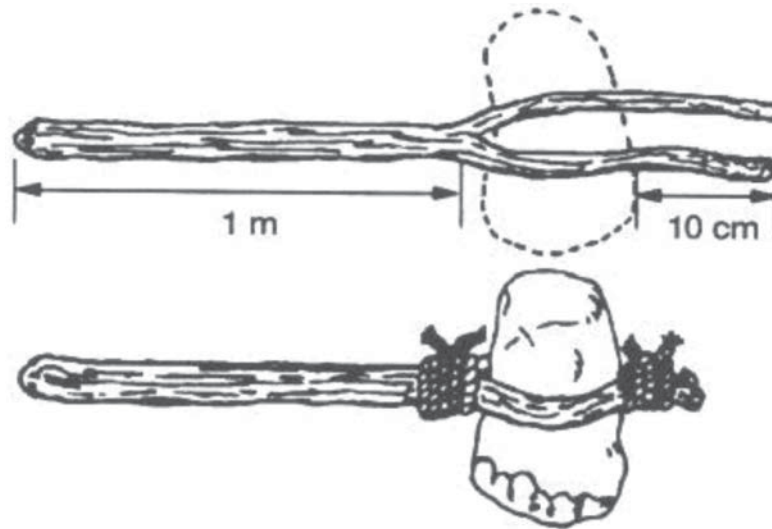

Figure 2 Forked Stick Hammer

Note. From *U.S. Army Survival Handbook* (p. 134), by Department of the Army, 2002, Guilford, CT: The Lyons Press.

To make a thinned stick hammer use the following steps:

1. Using a small stone, chip the hammer stone to create a shallow groove around its circumference for the wood to wrap.
2. Shave the end to half the diameter, long enough to wrap around the stone and meet the handle.
3. Wrap the wood around the stone head and lash securely.

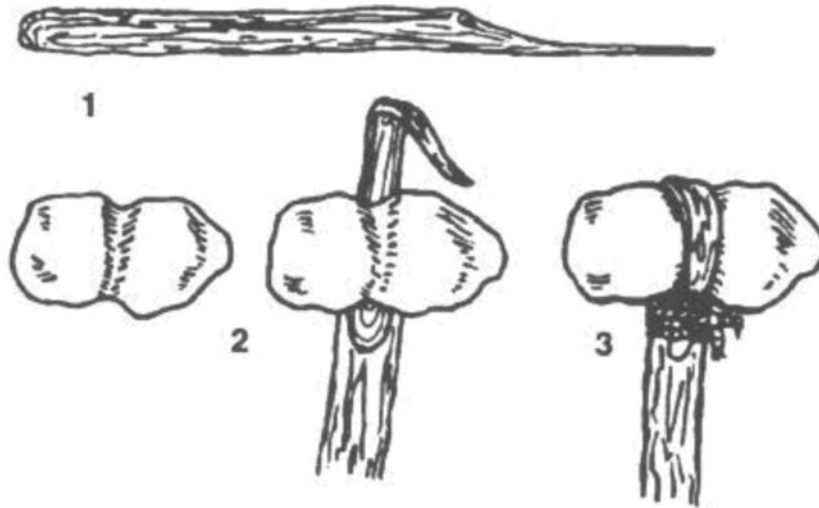

Figure 3 Thinned Stick Hammer

Note. From *U.S. Army Survival Handbook* (p. 134), by Department of the Army, 2002, Guilford, CT: The Lyons Press.

Wooden sticks can be attached to a stone to act as a handle. The handle increases the length of the swing radius, increasing the speed of the hammer head and the force delivered to the object being struck. It also keeps the user's hand away from the point of impact and reduces the shock of the blow to the user's hands. It is important to size the handle to the stone and the task. A handle that is too long results in an unwieldy tool and too short is inefficient.

The handle should be carefully constructed from green wood and attached securely to the stone. The diameter of the handle should be the same size as the user's index and middle finger combined. A split stick, Y-shape stick with the tines wrapped around or a stick thinned where it wraps around the stone will be more secure (as illustrated in Figures 1–3). The joint is strengthened by grooving the stone by chipping around its circumference, and lashing using a wet leather thong, wire, strong cordage or sinew for the binding.

Be conscious of the arc of the striking tool. If the stone separates from the handle, it has the potential to strike anything in that arc.

A piece of wood can also be used as a striking implement. The handle sizing remains the same as for a stone hammer. Larger diameter sections of log are reduced in the handle area to the proper handle size. This hammer or club is used either split or cut a piece of wood by hitting the back of the knife held in the opposite hand. This type of hammer or club does not last long in use as the objects being struck are usually wood, stone, or metal, which are harder than the club, causing it to splinter.

CONFIRMATION OF TEACHING POINT 4

QUESTIONS:

- Q1. What are some uses for a stone hammer?
- Q2. How should the stone be attached to the handle?
- Q3. Why will a wooden club not last long?

ANTICIPATED ANSWERS:

- A1. A stone can be used as a hammer for driving sticks into the ground, dispatching fish and small animals.
- A2. The stone should be attached to the handle by lashing using a wet leather thong, wire, strong cordage or sinew for the binding
- A3. A hammer or club will not last long in use as the objects being struck are usually wood, stone or metal which is harder than the club, causing it to splinter.

END OF LESSON CONFIRMATION

The cadets' improvisation of tools will serve as the confirmation of this lesson.

CONCLUSION

HOMEWORK / READING / PRACTICE

Nil.

METHOD OF EVALUATION

Nil.

CLOSING STATEMENT

The ability to improvise tools using found material can make the task of surviving easier. There will always be material in the area around the survivor. Identifying what they can be used for to assist in a survival situation is an asset.

INSTRUCTOR NOTES / REMARKS

Cadets who are qualified Survival Instructor may assist with this instruction.

REFERENCES

A3-016 B-GA-217-001/PT-001 Director Air Operations and Training. (1978). *Down but not out*. Ottawa, ON: Department of National Defence.

THIS PAGE INTENTIONALLY LEFT BLANK



**ROYAL CANADIAN AIR CADETS
PROFICIENCY LEVEL FOUR
INSTRUCTIONAL GUIDE**



SECTION 8

EO C490.03 – MOVE A CASUALTY TO SHELTER

Total Time:

90 min

PREPARATION

PRE-LESSON INSTRUCTIONS

Resources needed for the delivery of this lesson are listed in the lesson specification located in A-CR-CCP-804/PG-001, *Proficiency Level Four Qualification Standard and Plan*, Chapter 4. Specific uses for said resources are identified throughout the instructional guide within the TP for which they are required.

Review the lesson content and become familiar with the material prior to delivering the lesson.

There is no requirement for a qualified first aid instructor to teach the material contained in this lesson; however, the instructor should be a qualified first-aider.

Samples of improvised stretchers should be fabricated before conducting this lesson to use as examples.

PRE-LESSON ASSIGNMENT

Nil.

APPROACH

A practical activity was chosen for TP 1 as it is an interactive way to allow cadets to experience emergency scene management skills in a safe, controlled environment. This activity contributes to the development of first aid skills and knowledge in a fun and challenging setting.

A demonstration and performance was chosen for TPs 2 and 3 as it allows the instructor to explain and demonstrate moving a casualty to shelter and fabricating an improvised stretcher while providing an opportunity for the cadets to practice and develop these skills under supervision.

An interactive lecture was chosen for TP 4 to introduce the cadets to assessing the situation and caring for a casualty.

INTRODUCTION

REVIEW

Nil.

OBJECTIVES

By the end of this lesson the cadet shall have moved a casualty to shelter.

IMPORTANCE

It is important for the cadets to be able to perform first aid skills as injuries are a common occurrence in field settings. Having an understanding of moving a casualty to shelter, using proper carrying techniques and improvised stretchers, as well as, performing ongoing care will allow the cadets to take action in an emergency during a survival situation.

Teaching Point 1

Conduct an activity where the cadets will practice emergency scene management.

Time: 15 min

Method: Practical Activity



Qualified first-aiders must assist in the conduct of this TP.

EMERGENCY SCENE MANAGEMENT

Scene Survey

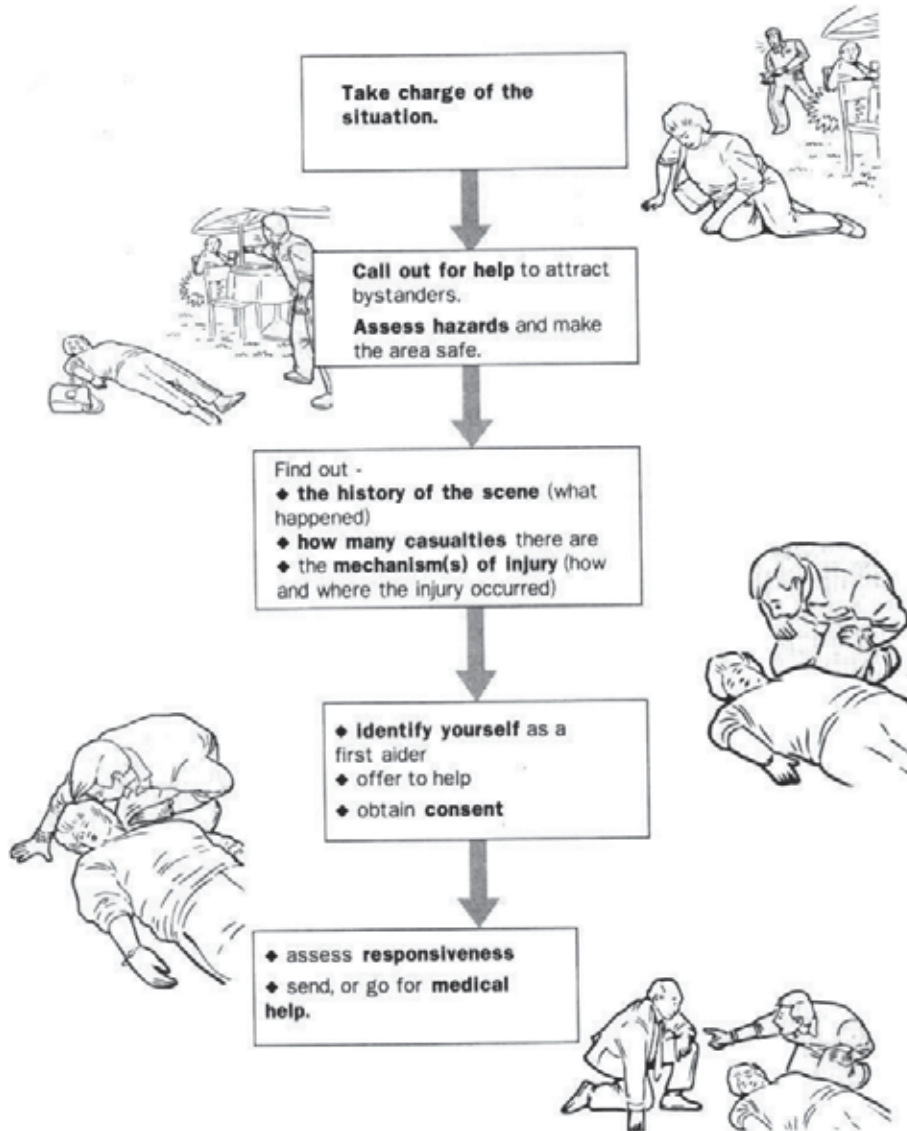

Figure 1 Scene Survey

Note. From *Military First Aid Safety Oriented Basic and Standard Levels Student Reference Guide* (p. 1-12), by St. John Ambulance, 2006, Ottawa, ON: National Defence Headquarters. Copyright 2006 by Priory of Canada of the Most Venerable Order of the Hospital of St. John Jerusalem.

Primary Survey

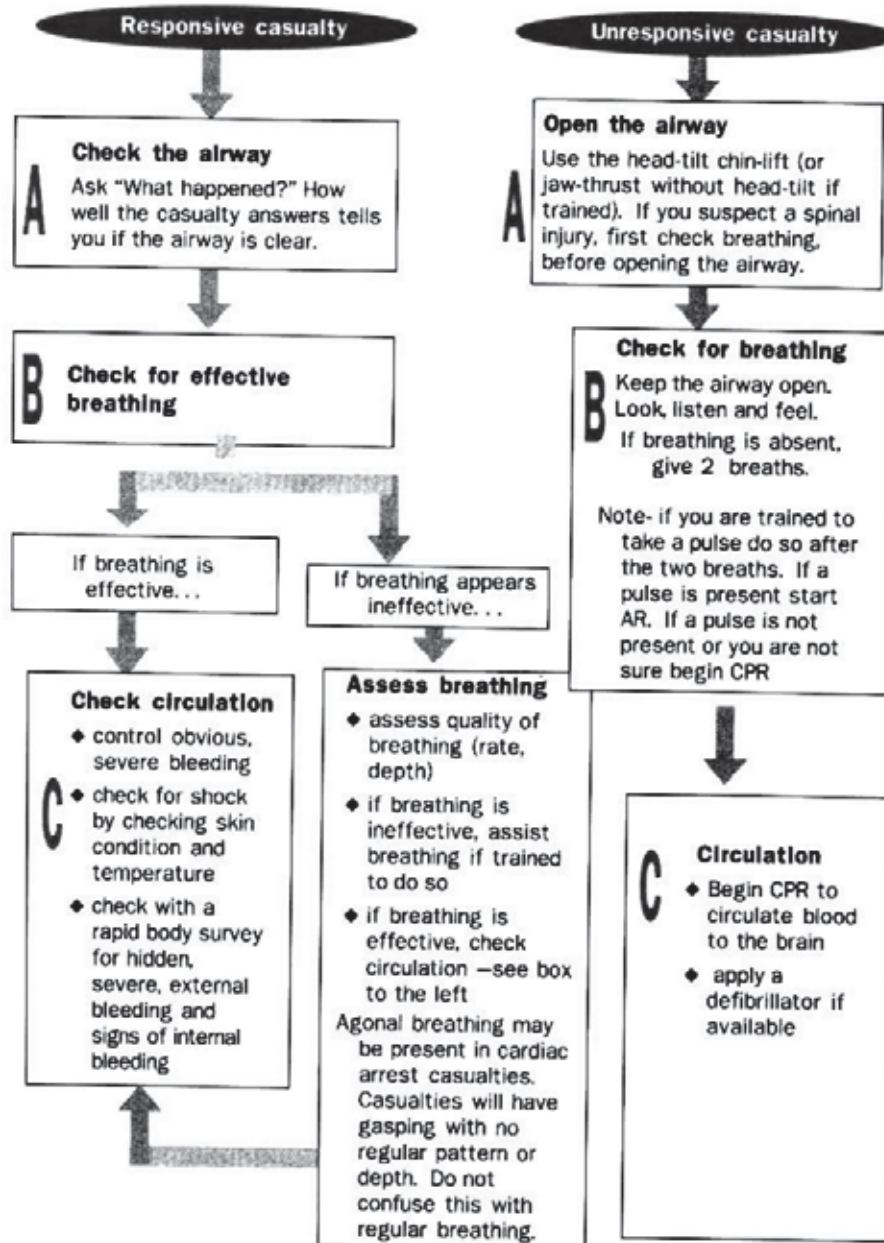

Figure 2 Primary Survey

Note. From *Military First Aid Safety Oriented Basic and Standard Levels Student Reference Guide* (p. 1-13), by St. John Ambulance, 2006, Ottawa, ON: National Defence Headquarters. Copyright 2006 by Priory of Canada of the Most Venerable Order of the Hospital of St. John Jerusalem.

Secondary Survey

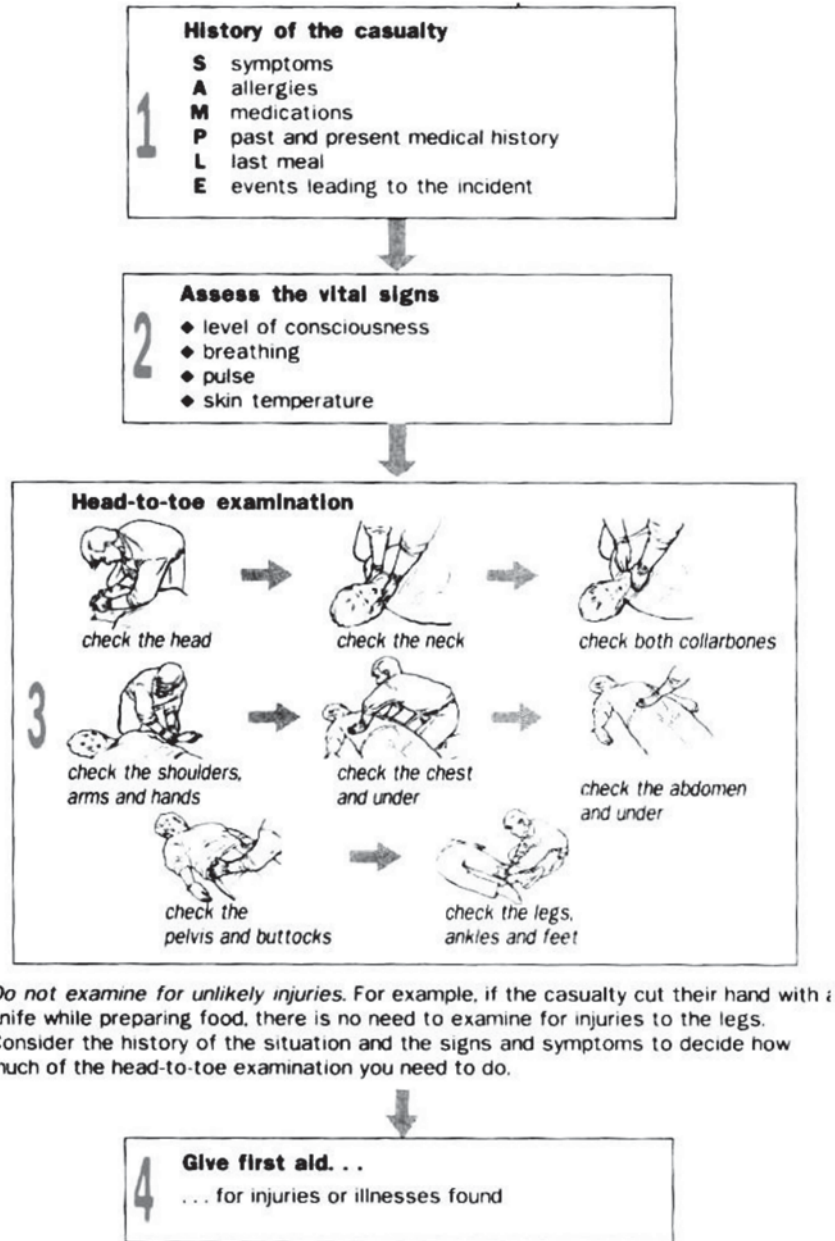

Figure 3 Secondary Survey

Note. From Military First Aid Safety Oriented Basic and Standard Levels Student Reference Guide (p. 1-14), by St. John Ambulance, 2006, Ottawa, ON: National Defence Headquarters. Copyright 2006 by Priory of Canada of the Most Venerable Order of the Hospital of St. John Jerusalem.

Ongoing Casualty Care

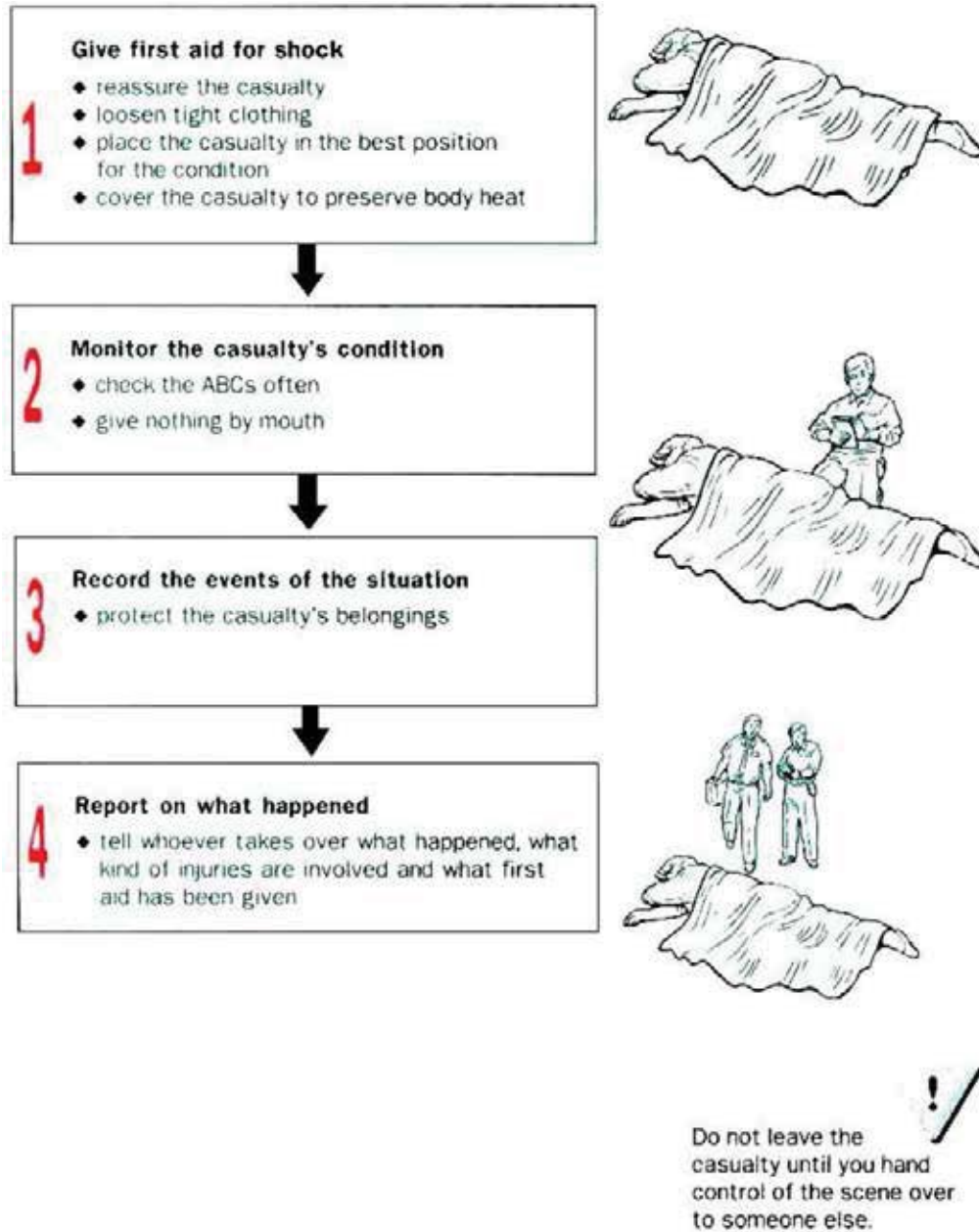

Figure 4 Ongoing Casualty Care

Note. From *Military First Aid Safety Oriented Basic and Standard Levels Student Reference Guide* (p. 1-15), by St. John Ambulance, 2006, Ottawa, ON: National Defence Headquarters. Copyright 2006 by Priory of Canada of the Most Venerable Order of the Hospital of St. John Jerusalem.

ACTIVITY

OBJECTIVE

The objective of this activity is to have the cadets review emergency scene management.

RESOURCES

Scenarios located at Attachment A.

ACTIVITY LAYOUT

Nil.

ACTIVITY INSTRUCTIONS

1. Divide the cadets into a group of three.
2. Assign a casualty, a first-aider and a bystander for each group.
3. Distribute a scenario to each group.
4. Have the cadets use the steps of emergency scene management to simulate providing first aid to the casualties.
5. Debrief the cadets on their performance during the scenario.

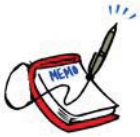

If time allows, cadets may change roles within the group.

SAFETY

Nil.

CONFIRMATION OF TEACHING POINT 1

The cadets' participation in the activity will serve as the confirmation of this TP.

Teaching Point 2

Explain, demonstrate and have the cadets, in pairs / groups of three, move a casualty to shelter.

Time: 20 min

Method: Demonstration and Performance

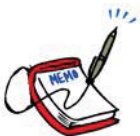

For this skill TP, it is recommended that the instruction take the following format:

1. Explain and demonstrate each carry while the cadets observe.
2. Explain and demonstrate each step required to complete the skill. Monitor the cadets as they imitate each step in pairs / groups of three.
3. Monitor the cadets' performance as they practice the complete skill.

Note: Assistant instructors may be used to assist with carries and monitor the cadets' performance.

MOVING AND CARRYING OVER SHORT DISTANCES

Many wilderness survival emergencies require moving or carrying a casualty a short distance, with usually only one or two rescuers. It is difficult to carry an adult for any distance and it is easy to injure them further while carrying. The following methods are used to minimize the chance of causing further injury while moving a casualty to shelter.

Drags

A casualty should be dragged only if they must be moved quickly out of danger, severe cold, strong winds, blowing snow or water. It is important to assess the casualty before attempting a drag because some injuries, if not yet stabilized, may be aggravated by premature movement. If there is only one rescuer, dragging may be the only means of moving a casualty.

When dragging a casualty, observe the following rules:

- Drag a casualty headfirst. This allows the head and neck to be supported and keeps the body straight.
- Keep the body in-line. The casualty's body must not twist or bend. Avoid major bumps.
- The neck should not bend sharply, nor should the head fall forward, back or to the side.

Steps to drag a casualty:

1. If possible, secure the casualty's hands before beginning the drag.
2. Reach under the casualty's body and grip their clothing just below their shoulder on either side while supporting the head and neck using the forearms.
3. Crouch or kneel and walk backwards (as illustrated in Figure 5).
4. Stop when the casualty is out of danger.



This drag is hard on the rescuer's back, so be careful.



Figure 5 Drag

Note. From *St. John Ambulance: The Official Wilderness First Aid Guide* (p. 21), by W. Merry, 1994, Toronto, ON: McClelland & Stewart Inc. Copyright 1997 by St. John Ambulance.

5. If the casualty's clothing pulls up too much or tears, place a shirt or jacket over their chest and bring the sleeves under their back to provide a firm grip (as illustrated in Figure 6).



The first-aider can use cuff buttons or Velcro, mitten ties or a piece of cord to assist in this drag.



Figure 6 Modified Drag

Note. From St. John Ambulance: The Official Wilderness First Aid Guide (p. 21), by W. Merry, 1994, Toronto, ON: McClelland & Stewart Inc. Copyright 1997 by St. John Ambulance.

Tarp Drag Method



Rarely should lifts or carries be done on snow because of the possibility of the rescuer slipping; it is safer and easier to drag a casualty on a tarp or sled.

The tarp drag method works well on snow. A rescuer may make a ramp of snow and slide a casualty onto a sled. This drag is also a good way to move a casualty onto insulating material to protect them from the cold ground or snow.

One may wish to leave the tarp under the casualty to aid in another lift. Always put the casualty into a basket stretcher with a backboard, blanket or tarp under them, as it is otherwise difficult to remove them without excessive movement.



Be careful when using the tarp drag method on sloping snow as control may be lost on a downhill slope.

Dragging a casualty on a tarp, blanket, sail, tent or large hide can be accomplished by following these steps:

1. Place the tarp next to the casualty.
2. Fold the tarp into accordion folds of about 1 m (3 feet) wide.
3. Log-roll the casualty by:
 - a. assigning a person to the head, torso, and foot of the casualty;
 - b. having the person at the head of the casualty control the roll and signal the start by counting to the three;
 - c. having the first-aiders roll the casualty towards the person who is at the torso;

- d. placing half of the tarp underneath the casualty while holding them securely on their side;
 - e. having the person at the head of the casualty count to three to signal the other first-aiders to roll the casualty back to their back.
4. Take the tarp that has been coiled underneath the casualty and pull it taut until the tarp is flat.



Figure 7 Rolling Onto a Tarp

Note. From *St. John Ambulance: The Official Wilderness First Aid Guide* (p. 21), by W. Merry, 1994, Toronto, ON: McClelland & Stewart Inc. Copyright 1997 by St. John Ambulance.

5. Grip the tarp and hold the casualty's head and shoulders off the ground and drag carefully.



Figure 8 Tarp Drag

Note. From St. John Ambulance: The Official Wilderness First Aid Guide (p. 21), by W. Merry, 1994, Toronto, ON: McClelland & Stewart Inc. Copyright 1997 by St. John Ambulance.

Single-Rescue Carries

Most single-rescue carries are for short distances and cannot be used to transport a casualty with major injuries. All are extremely strenuous. They are often used to transport casualties with injuries of the lower extremities but care must be taken as it is easy to cause further injuries.

Packstrap Carry

This is a quick, easy carry for very short distances. The casualty must be able to stand to get into position with their arms across the shoulders like packstraps. Bring the casualty's arms across the shoulders, crossing their wrists in front. Hold their wrists while bending forward and lift the casualty's feet off the ground. Be sure their arms are bent at the elbow.



Figure 9 Packstrap Carry

Note. From *St. John Ambulance: The Official Wilderness First Aid Guide* (p. 23), by W. Merry, 1994, Toronto, ON: McClelland & Stewart Inc. Copyright 1997 by St. John Ambulance.

Piggyback Carry

This familiar carry is good for short-distance transport of conscious casualties with minor injuries and may be used to carry children for long distances.



Figure 10 Piggyback Carry

Note. From *St. John Ambulance: The Official Wilderness First Aid Guide* (p. 23), by W. Merry, 1994, Toronto, ON: McClelland & Stewart Inc. Copyright 1997 by St. John Ambulance.

Carrying Seat

A quick and easy backpack seat to assist the piggyback system may be made with a simple loop of wide strap. It may be necessary to adjust the length once or twice for maximum comfort. This seat is best used if the casualty is lighter than the rescuer, otherwise it may put pressure on the rescuer's neck and shoulders.



Figure 11 Carrying Seat With Wide Strap

Note. From *St. John Ambulance: The Official Wilderness First Aid Guide* (p. 23), by W. Merry, 1994, Toronto, ON: McClelland & Stewart Inc. Copyright 1997 by St. John Ambulance.

CARRYING OVER LONG DISTANCES USING TWO-PERSON CARRIES

Lifting is half as strenuous if there are two rescuers; however carrying for any distance is usually not easier because two carriers must compensate for each other's movements to keep balanced. The chance of error is multiplied with each added person in a lifting team and injury to the casualty often occurs if lifts are poor. Whenever more than one person lifts, observe the following rules:

- One person must be clearly designated as the leader and be responsible for giving all of the commands.
- The partner(s) must be told exactly what is to be done and what the commands will be.
- The lift should first be practiced without the casualty or on an uninjured person.
- Rescuers should maintain eye contact while lifting.

The Fore-and-Aft Lift and Carry

This should be used only if the casualty has minor injuries. On uneven terrain, it may be the easiest method of lifting a casualty onto a stretcher or another means of transport. As it produces some pressure against the chest, it will restrict the casualty's air flow. Follow these steps:

1. If the casualty is conscious, help them sit up. If the casualty is unconscious, have a partner take the casualty's hands and pull them into the sitting position.

2. Cross the casualty's arms on their chest.
3. Crouch behind them, reach under their arms and grasp the casualty's wrist.
4. Have your partner crouch between the casualty's knees, facing the casualty's feet and take a leg under each arm.
5. At the leader's signal, rise, keeping your back straight.



Figure 12 Fore-and-Aft Lift and Carry

Note. From *St. John Ambulance: The Official Wilderness First Aid Guide* (p. 26), by W. Merry, 1994, Toronto, ON: McClelland & Stewart Inc. Copyright 1997 by St. John Ambulance.

Two-Hand Seat

This two-person lift and carry is good for casualties who cannot hold onto the rescuer's shoulders for support, or who are not fully alert.

1. Rescuers crouch on either side of the casualty.
2. Each rescuer will slide one hand under the casualty's thighs and lock fingers over a pad or while wearing mittens or gloves so that fingernails do not dig into each other (as illustrated in Figure 13).

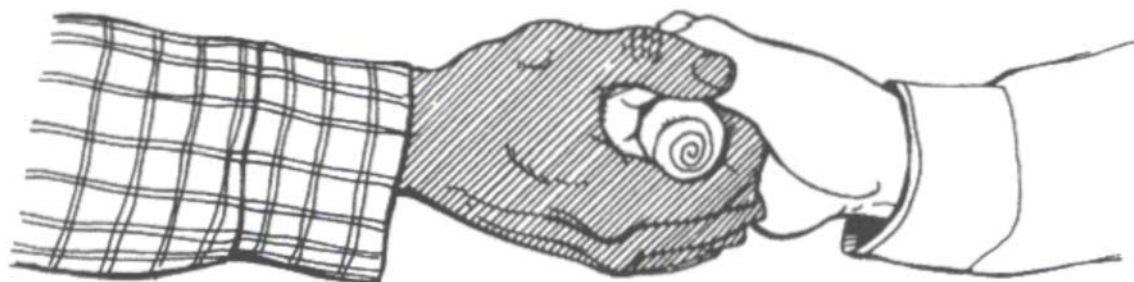

Figure 13 Hand Grip

Note. From *St. John Ambulance: The Official Wilderness First Aid Guide* (p. 26), by W. Merry, 1994, Toronto, ON: McClelland & Stewart Inc. Copyright 1997 by St. John Ambulance.

3. Reach across the casualty's back and grip their belt and pants at the opposite hip; the rescuers' arms are crossed (as illustrated in Figure 14).
4. At the leader's signal, raise and step off with the inside foot. This supports the casualty's back; however, the fingers of the gripping hands will tire quickly.



Figure 14 Two-Person Lift

Note. From *St. John Ambulance: The Official Wilderness First Aid Guide* (p. 26), by W. Merry, 1994, Toronto, ON: McClelland & Stewart Inc. Copyright 1997 by St. John Ambulance.

For longer carries, try gripping your partner's wrists rather than their fingers. If wearing mittens, gripping the wrist will be more secure than gripping the hand. If the casualty is unconscious, they may be lifted easily to a sitting position. One rescuer pulls on the casualty's hands while the other lifts and supports their head; then the rescuers move into position while supporting the casualty's head and back.



Figure 15 Two-Person Carry

Note. From *St. John Ambulance: The Official Wilderness First Aid Guide* (p. 26), by W. Merry, 1994, Toronto, ON: McClelland & Stewart Inc. Copyright 1997 by St. John Ambulance.

CONFIRMATION OF TEACHING POINT 2

The cadets' performing the rescue carries will serve as the confirmation of this TP.

Teaching Point 3

Explain, demonstrate and have the cadets, as members of a group, fabricate an improvised stretcher.

Time: 30 min

Method: Demonstration and Performance

FABRICATE AN IMPROVISED STRETCHER

If a person is injured and the situation requires that the casualty be moved, an improvised stretcher may be required. When fabricating an improvised stretcher, follow these steps:

1. **Inventory the available resources.** What materials are available to fabricate a stretcher? Any materials may be used, from natural resources to parts of a downed aircraft. Roots to wiring may be used as cordage and wooden poles to a section of a wing of an aircraft as the frame. Materials that make the casualty comfortable; from spruce boughs to blankets. Examine everything that may be of use.
2. **Fabricate the improvised stretcher.** Once the materials have been gathered, they need to be fabricated into the stretcher. Care should be made to ensure both the strength of the stretcher and the comfort of the casualty.
3. **Test the durability of the stretcher before use.** Before placing the casualty on the stretcher, it should be tested to ensure it is both strong and comfortable. If the stretcher comes apart, dropping the casualty,

it may make a bad situation worse. If the stretcher is not comfortable, it may cause further injury or make the casualty move around, trying to get comfortable, making the stretcher more difficult to carry.



For this skill TP, it is recommended that instruction take the following format:

1. Explain and demonstrate each type of improvised stretcher while the cadets observe.
2. Explain and demonstrate each step required to complete the skill. Monitor the cadets as they imitate each step in groups.
3. Monitor the cadets' performance as they practice the complete skill.

Note: Assistant instructors may be used to assist with fabricating of the improvised stretchers and to monitor the cadets' performance.

EXAMPLES OF IMPROVISED STRETCHERS

Pole Stretcher

A very stable stretcher, but the casualty may need to be secured to prevent their sliding off.

RESOURCES

- Two poles approximately 3 m long,
- 10–12 sticks approximately 60 cm long,
- Cordage, and
- Blanket.

ACTIVITY INSTRUCTIONS

1. Lay the two long poles approximately 50 cm apart.
2. Using the cordage, tie the short sticks across the gap to create a bed approximately 2 m long.
3. Lay the blanket over the stretcher.
4. Test the stretcher by having one cadet at the head and one cadet at the foot of a volunteer, standing between the poles, using their legs (not their backs), in unison, lift the volunteer.

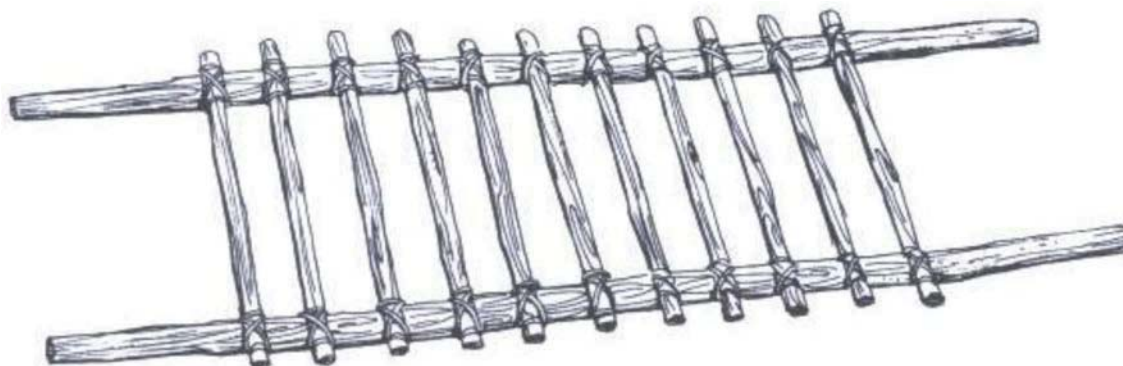

Figure 16 Pole Stretcher

Note. From *St. John Ambulance: The Official Wilderness First Aid Guide* (p. 31), by W. Merry, 1994, Toronto, ON: McClelland & Stewart Inc. Copyright 1997 by St. John Ambulance.

Rolled Pole Stretcher

Easy to fabricate and requires minimal resources. However, there is a possibility of the casualty being compressed within the stretcher, which may cause further injury.

RESOURCES

- Two poles approximately 3 m long, and
- One tarp.

ACTIVITY INSTRUCTIONS

1. Lay the casualty on the centre of the tarp.
2. Roll each pole into the tarp, one on each side, parallel to the casualty (see Figure 17).
3. Test the stretcher by having one cadet at the head and one cadet at the foot of a volunteer, standing between the poles, using their legs (not their backs), in unison, lift the volunteer.



Figure 17 Rolled Pole Stretcher

Note. From *St. John Ambulance: The Official Wilderness First Aid Guide* (p. 29), by W. Merry, 1994, Toronto, ON: McClelland & Stewart Inc. Copyright 1997 by St. John Ambulance.

Shirt Stretcher

Easy to fabricate and requires minimal resources. However, there is a possibility of the casualty being compressed within the stretcher, which may cause further injury. There is also the possibility of the casualty falling between a gap between two shirts.

RESOURCES

- Two poles approximately 3 m long, and
- Two to four shirts.

ACTIVITY INSTRUCTIONS

1. Insert the poles into the sleeves and bodies of the shirts to create a bed approximately 2 m long. Ensure that any fasteners (eg, buttons, zippers) are fastened.
2. Test the stretcher by having one cadet at the head and one cadet at the foot of a volunteer, standing between the poles, using their legs (not their backs), in unison, lift the volunteer.

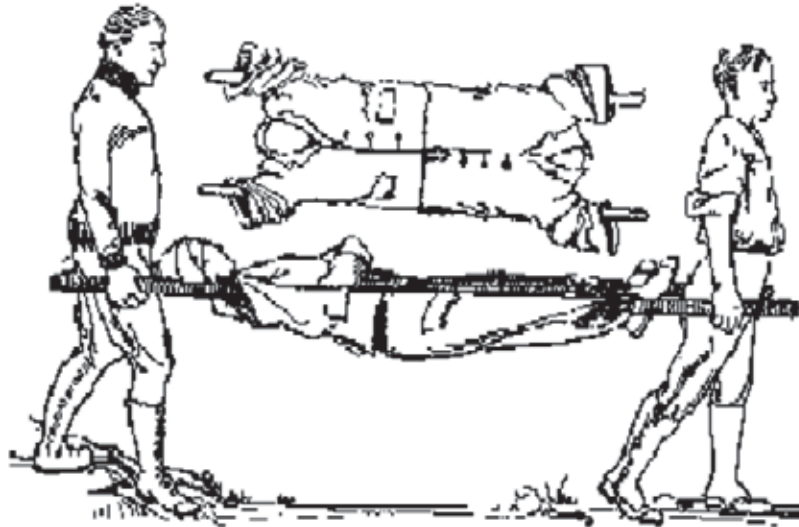

Figure 18 Shirt Stretcher

Note. From "Soil and Health Library", by S. Solomon, 2007, *First Aid in Accidents*. Retrieved March 17, 2009, from <http://www.soilandhealth.org/02/0201hyglibcat/020146.lindlahr.nat.therap/Nat.Thera.Pt5.htm>

CONFIRMATION OF TEACHING POINT 3

The cadets' fabricating improvised stretchers will serve as the confirmation of this TP.

Teaching Point 4

Time: 15 min

Discuss casualty care.

Method: Interactive Lecture

DISCUSS CASUALTY CARE

In a survival situation, there may be a long time between administering first aid and getting the casualty to medical help. The first-aider is required to administer ongoing casualty care until rescued / found. The first-aider should focus on the following:

Breathing

When someone is inactive deep breaths are rarely, if ever, taken. Shallow breathing may allow fluids and mucus to build up in the lungs. This promotes the growth of bacteria and for the possibility of the casualty catching pneumonia. It is important for the casualty to take deep breaths and to cough, even if it hurts. If the injury permits, place the casualty in a semi-sitting position to make it easier to take deeper breaths / cough. Semi-sitting also makes it easier for the casualty to hold their sides, which may make taking deeper breaths / coughing less painful.

Warmth

The body, when injured, uses energy to try to heal itself. This results in less energy to maintain body heat which means an injured person can take twice as long to replace lost body heat.



Never assume that because you are warm, a casualty is also warm.

It is easier to cool a person down than to warm them up, therefore it is better to keep a casualty warm. Keep the casualty dry, if possible wearing layers or in a sleeping bag. Put extra padding / insulation between the casualty's body and the ground. Care must be taken when using clothing that does not breathe as condensation will form from the casualty's body as this will make the inner layers damp, however, it should be used to protect from the rain and the wind.

Rocks warmed by the fire and wrapped in cloth will act as a portable heater; however, ensure that the rock is not as hot as to burn. If the casualty is unconscious, check the casualty often and move / replace the heated rock as required.

Body's Position

Body position may have a profound effect on the casualty. Often, a casualty may want to get into a different position. If the injury is not affected, allow the casualty to get into their own comfortable position. Certain positions will produce specific results, as follows:

- **Recovery position.** This position should be used if the casualty is unconscious, or not fully alert.
- **Semi-sitting position.** This position makes it easier for the casualty to breathe as it reduces the pressure of the abdomen on the lungs.
- **Knees raised position.** This position reduces tension on the chest and abdomen making injuries there less painful.
- **Shock position (on the back with legs slightly raised).** This position is used if the casualty is in shock or faint.
- **Elevation of injured arms / legs.** These positions will help reduce swelling / bleeding to the injured limb.
- **Most comfortable position.** Sometimes it may be necessary to place a casualty into a position that they find to be the most comfortable.

If a casualty maintains the same position for several days, watch out for bedsores. If bedsores develop, treated them the same as an infected wound and do not place the casualty back into the same position. This will only aggravate the treated bedsores.

Morale

Reassurance is important during every moment of a casualty's care. As in a survival situation, fear greatly reduces a person's will to survive. A survival situation combined with an injury multiplies the effect of fear. Ways to maintain a casualty's morale include:

- Staying cheerful and optimistic even if personally discouraged.
- Reassuring the casualty often.
- Always explaining to the casualty what is being done to them.
- Touching the casualty often in an appropriate, comforting and companionable way. Warm human contact is a major part of reassurance.
- Not discussing the casualty's condition in their hearing unless it is optimistic.
- Involving the casualty in their own care by encouraging them to do as much as possible for themselves.
- Keeping the casualty informed of / part of any plans. For example, if someone is leaving the survival site to gather berries, tell the casualty so they do not worry about the possibility that they are being abandoned.

Rest

Rest promotes healing, reduces tendencies to bleed or swell, and often reduces pain and stress. Sometimes, pain will prevent adequate rest. If pain medications are available and are used as prescribed, they will help the casualty to rest.

Fluid Intake

Maintaining fluid levels is very important, especially for an injured person. Fluids should not be given to a person with internal injuries or who is vomiting. Unfortunately, dehydration over a day or two may cause more damage than small amounts of fluids, even when they are not recommended in normal first aid practice. The following should be considered:

- Give no fluids if the casualty is unconscious, feels nauseated or is vomiting, or has abdominal injuries.
- Give only small amounts at first until it can be determined whether the casualty will vomit or not. Always be ready for vomiting.
- Give small amounts often rather than lots at once. If the casualty can barely swallow, give sips every five or ten minutes.
- If possible, give nutritious fluids. However, do not give alcohol, coffee, tea, hot chocolate or any drinks with caffeine as these are diuretics which increase urine output and increase the possibility of dehydration.
- Give water to any shock, burn or dehydration casualty who can tolerate it.
- Maintain liquid intake of at least five to six litres / day. If there are signs of dehydration, encourage the casualty to drink more.

Urination

A person normally urinates about one litre per day. If there is less than expected, suspect shock / dehydration. If the urine is bloody, discoloured, or has a strong smell, record this information. If the casualty's injury prevents them from urinating on their own, improvise a bedpan / urinal. Always try to maintain the casualty's dignity.

RECORDING ALL OBSERVATIONS

It is very important to record all observations, including the date and time. Also record what was done (eg, first aid provided, what drunk / eaten, symptoms, vital signs, bowel movements, urination) and when. Be alert to changes as these are signs of changes in the casualty's condition. This information may be of assistance to the medical personnel who will be taking over the care for the casualty.

CONFIRMATION OF TEACHING POINT 4

QUESTIONS:

- Q1. Describe three (of the five) body positions discussed.
- Q2. What is the importance of rest?
- Q3. Why should all observations be recorded?

ANTICIPATED ANSWERS:

A1. The six positions discussed:

- **Recovery position.** This position should be used if the casualty is unconscious, not fully alert, or is nauseated and may vomit.
- **Semi-sitting position.** This position makes it easier for the casualty to breathe as it reduces the pressure of the abdomen on the lungs.
- **Knees raised position.** This position reduces tension on the chest and abdomen making injuries there less painful.
- **Shock position (on the back with legs slightly raised).** This position if used if the casualty is in shock or faint. However, if the is breathing problems or a chest / abdominal injury, make sure just the legs, and not the whole body, is raised to reduce pressure on the abdomen / lungs.
- **Elevation of injured arms / legs.** These positions will help reduce swelling / bleeding to the injured limb.
- **Most comfortable position.** Sometimes it may be necessary to place a casualty into a position that they find to be the most comfortable.

A2. Rest promotes healing, reduces tendencies to bleed or swell, and often reduces pain and stress.

A3. Alerts the caregiver to changes as these may be signs of changes in the casualty's condition. This information may be of assistance to the medical personnel who will be taking over the care for the casualty.

END OF LESSON CONFIRMATION

The cadets' moving a casualty to shelter will serve as the confirmation of this lesson.

CONCLUSION

HOMEWORK / READING / PRACTICE

Nil.

METHOD OF EVALUATION

Nil.

CLOSING STATEMENT

It is important for the cadets to be able to perform first aid skills as injuries are a common occurrence in field settings. Having an understanding of moving a casualty to shelter, using proper carrying techniques and improvised stretchers, as well as, performing ongoing casualty care will allow the cadets to take action in an emergency during a survival situation.

INSTRUCTOR NOTES / REMARKS

Cadets who are qualified Survival Instructor or qualified first-aiders in Proficiency Level Four may assist in the conduct of this EO.

The assessment of the casualty in order to move the casualty will be conducted by the qualified first-aider.

Samples of improvised stretchers should be fabricated before conducting this lesson to use as examples.

REFERENCES

A0-134 A-MD-050-072/PW-001 Canadian Forces (2006). *Military first aid: Safety oriented: Basic and standard levels: Activity book*. Ottawa: Department of National Defence.

C2-030 ISBN 0-7710-8250-9 Merry, W. (1994). *St. John Ambulance: The official wilderness first aid guide*. Toronto, ON: McClelland & Stewart Inc.

THIS PAGE INTENTIONALLY LEFT BLANK

EMERGENCY SCENE MANAGEMENT SCENARIOS

Scenario 1

A shopper has fallen while slipping on the wet floor and hits his/her head and is unconscious. There is one employee trained in first aid and another shopper is willing to assist until medical help arrives.

Scenario 2

A spectator in an arena falls down a set of stairs. You are a St. John Ambulance volunteer who must respond and perform Emergency Scene Management for the casualty who has suspected head / spinal injuries.

Scenario 3

Three first year cadets are inside of a modular tent during a thunderstorm. The first cadet is leaning against the pole and lightning strikes the tent. The first cadet receives burns to his back. The second cadet is trained in first aid and the third cadet will assist with the casualty until officers and medical help arrives.

Scenario 4

A cadet is using a knife to cut a piece of wood, while the cadet is doing this, another cadet close by bumps into the cadet. The cadet has cut their hand.. A few cadets are in the general area and hear the screams of the two cadets. One of them is trained in first-aid and assists until medical help arrives.

THIS PAGE INTENTIONALLY LEFT BLANK



ROYAL CANADIAN AIR CADETS
PROFICIENCY LEVEL FOUR
INSTRUCTIONAL GUIDE



SECTION 9

EO C490.04 – PRACTICE SAFE TOOLCRAFT

Total Time:

90 min

PREPARATION

PRE-LESSON INSTRUCTIONS

Resources needed for the delivery of this lesson are listed in the lesson specification located in A-CR-CCP-804/PG-001, *Proficiency Level Four Qualification Standard and Plan*, Chapter 4. Specific uses for said resources are identified throughout the instructional guide within the TP for which they are required.

Review the lesson content and become familiar with the material prior to delivering the lesson.

PRE-LESSON ASSIGNMENT

Nil.

APPROACH

A demonstration and performance was chosen for this lesson as it allows the instructor to explain and demonstrate the skills. The cadets are expected to sharpen a knife and an axe, and to cut wood while providing an opportunity for the cadets to practice the skills under supervision.

INTRODUCTION

REVIEW

Nil.

OBJECTIVES

By the end of this lesson the cadet shall be expected to practice safe toolcraft.

IMPORTANCE

It is important for the cadets to be able to safely use tools on an aircrew survival exercise. Tools support aircrew survival training by assisting the cadets in setting up an aircrew survival exercise site, erecting tents and starting fires. The cadets need to know how to safely use tools to prevent accidents.

Teaching Point 1**Explain, demonstrate and have the cadets handle, pass and store tools.**

Time: 25 min

Method: Demonstration and Performance



For this skill lesson it is recommended that the instruction take the following format:

1. Explain and demonstrate handling, passing and storing tools while the cadets observe.
2. Explain and demonstrate each step required to complete each skill. Monitor the cadets as they imitate each step.
3. Monitor the cadets' performance as they practice the complete skill.

Note: Assistant instructors may be used to monitor the cadets' performance.

HANDLING TOOLS

All tools need to be handled with great care and control. For this lesson, focus on the safe handling and passing of a knife, an axe and a bow saw, since these tools are most dangerous when used incorrectly.

These safety considerations should transfer to all other tools that are used during an aircrew survival training exercise.

Axe

A blade cover protects the user from injury, the cutting edge from damage and should be used if available. Always carry an axe by its head. Place two fingers on one side, and grip the neck with the other fingers and thumb on the other side. The handle should point horizontally to the ground and the blade should face outward.



Figure 1 Axe

Note. Created by Director Cadets 3, 2009 Ottawa, ON: Department of National Defence.

Bow Saw

A bow saw has a sharp long blade that should be covered when carrying for long distances. When the bow saw is carried short distances, the carrier should be aware of where the blade is at all times. Keep the blade facing away from the body and hold the handle firmly. It can be carried in hand, with the blade facing down.



Figure 2 Bow Saw

Note. Created by Director Cadets 3, 2009 Ottawa, ON: Department of National Defence.

Shovel

The shovel is to be handled at the upper part of the shaft toward the shoulder when carrying. The shovel blade should be facing the ground with the cutting edge pointing downward.



Figure 3 Spade Shovel

Note. Created by Director Cadets 3, 2009 Ottawa, ON: Department of National Defence.

Knives



Using a knife improperly can cause injuries and damage the knife. It is important to remember what the knife is designed to do. It is not designed to pry. This may damage the tip of the blade. The handle or butt is not a hammer.

A dull knife requires more energy to use and increases the risk of injury.

A knife can assist greatly during a survival situation but it is useless if it is broken by using it as a substitute for another tool.

When handling a knife, practice the following principles:

- Always cut away from the body or limbs, never toward.
- If the knife is dropped, let it fall to the ground as trying to catch it may cause serious injury.
- Never point a knife at anybody.
- If the knife is a fixed blade, always return it to the sheath when not in use.
- If the knife is of the folding variety, keep it folded away when not in use or keep it in a sheath.
- Never walk or run around with an open or unsheathed knife.

Ensure the knife is only used when the user can clearly see what they are doing. Use adequate lighting after dark.



Figure 4 Survival Knife

Note. From "Military Pictures", *Gerber Infantry Survival Knife*, Retrieved April 28, 2009, from <http://www.militarypictures.info/weapons/gerber.jpg.html>

PASSING TOOLS

When passing tools that have a sharp edge, adhere to the following steps:

1. The passer communicates the intent to pass the tool.
2. The receiver gives both a verbal response and eye contact that they accept.
3. The passer and the receiver stand facing each other.
4. The passer holds out the tool with both hands and the sharp edge down.
5. The passer waits for the recipient to place both hands on the tool.
6. The passer asks the recipient if they have control.
7. The recipient states that they have control.
8. The passer releases control of the tool.



These steps may seem overstated, but most accidents that occur when passing tools are a result of poor communication. It takes very little force for a sharp tool to severely injure.

STORING TOOLS

When storing tools, adhere to the following:

- Always clean tools before storing.
- Check tools frequently to ensure they are in operating condition.
- Always choose a tree close to the aircrew survival site to store tools or build a tool shelter.
- Store tools in a common area that is clearly identifiable.
- Mask or store axes and bow saws in a secure case when not in use (as illustrated in Figure 6)
- Keep all tools away from rain, snow and dirt.
- Do not leave an axe or a bow saw embedded in a stump as the sap causes the blade or bit to rust.
- Do not leave tools lying on the ground.
- Tools should not be stored against a tree even for a brief time.
- The user is responsible for the tool from the time it is taken from its case or storage area until it is returned.



Figure 5 Tool Rack

Note. From *Scoutmaster, Knots and Pioneering*, Copyright 2007 by Amazon.com, Inc. Retrieved November 18, 2007, from http://scoutmaster.typepad.com/.shared/image.html?/photos/uncategorized/chip5_copy_copy.jpg

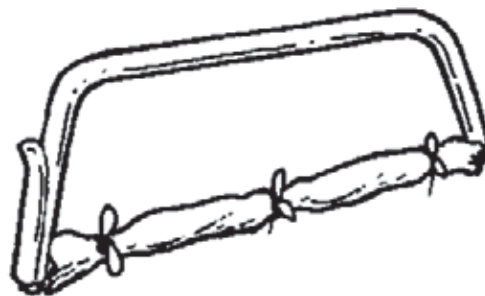

Figure 6 Storing a Bow Saw

Note From "Use of Axes and Saws", Copyright 2005 by ScoutBase UK. Retrieved April 28, 2009, from <http://www.scoutbase.org.uk/library/hqdocs/facts/pdfs/fs315070.pdf>

CONFIRMATION OF TEACHING POINT 1

The cadets' participation in handling an axe, a bow saw, a shovel and a knife, and safely passing and storing tools will serve as the confirmation of this TP.

Teaching Point 2**Explain, demonstrate and have the cadets clean and sharpen a knife and file and sharpen an axe.**

Time: 20 min

Method: Demonstration and Performance



For this skill lesson it is recommended that the instruction take the following format:

1. Explain and demonstrate cleaning and sharpening a knife and an axe while the cadets observe.
2. Explain and demonstrate each step required to complete the skill. Monitor the cadets as they imitate each step.
3. Monitor the cadets' performance as they practice the complete skill.

Note: Assistant instructors may be used to monitor the cadets' performance.

KNIVES

To preserve the life of a knife, only use it for its intended purpose. Do not use blades to pry things, punch holes, as a hammer, or as a screwdriver.

Cleaning

To clean a folding knife, open the blade and rinse with warm soapy water and dry well. It may be helpful to scrub it with an old toothbrush. Be careful when handling the knife while the blade is open.

When the knife is completely dry, lightly oil it with machine oil (or cooking oil if the knife is used for food). Wipe off any excess oil and close the blades.

It is important to keep the edge of a knife blade sharp, as a dull knife can be more dangerous than a sharp one. Do not exert too much pressure or use force to make a blade cut through something. By keeping the knife clean, dry and lightly oiled, it will not require sharpening as often.

When sharpening a knife it is important to keep it secure, maintain a uniform sharpening angle on both sides and be careful of cutting fingers. A sharpening stone is most practical for sharpening a knife.

Sharpening Using a Sharpening Stone and a Honing Stone

Sharpen a knife as soon as it becomes dull. Use a quality sharpening stone and apply lubricant as specified for the stone. To reshape an edge use a 400 grit sharpening stone. A 1 000 grit sharpening stone and above will sharpen the edge. A honing stone is used to polish the cutting edge and is usually above 2 000 grit. To polish a blade that has stains on it, use wood ash as it will not scratch the blade. Use the following steps when sharpening a knife with a sharpening stone:

1. Apply a light coating of oil (if it is a whetstone or oil stone) to the stone to lubricate and protect the surface. The oil helps keep bits of stone and steel—called slurry—on the surface of the stone. The slurry helps the cutting action of the stone. Ceramic and diamond stones can be used dry or wetted with water.
2. If a combination stone is being used, start with the coarsest grit side.



A hollow ground blade will be sharpened only at the cutting edge at a combined angle 20–30 degrees.

3. To sharpen a hollow ground blade hold the knife with the back edge of the knife off the sharpening stone at 10–15 degrees.
4. To sharpen a flat ground blade, place the bevel flat on the stone. This will register the blade at the proper angle for sharpening.
5. Start where the blade meets the handle and draw the full length of the blade across the stone while moving the blade from one end of the stone to the other. Apply steady pressure. Repeat this eight times on each side.
6. Repeat the process using the fine side of the sharpening stone.
7. Using a honing stone and honing oil, hone the blade, alternate each stroke with the opposite side of the blade for eight strokes maintaining the same angle as before.
8. If a wire edge forms—a thin wire of steel at the very edge of the blade—repeat the same motion on a piece of card board or honing stone until the wire edge falls off.
9. Test for sharpness by cutting something or by looking at the edge of the blade for reflections from unsharpened areas, not by drawing the fingers across the blade.
10. Clean and dry the stone following the manufacturers' instructions.

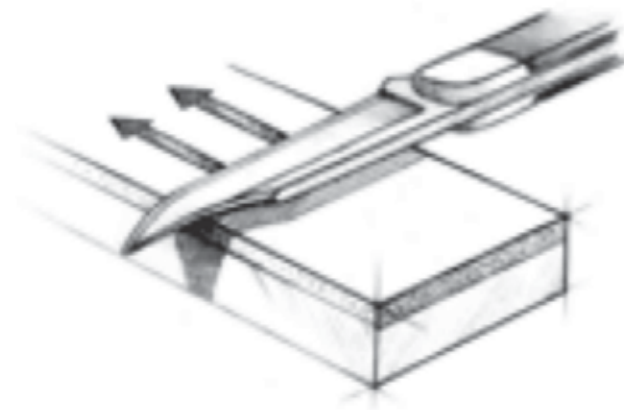

Figure 7 A Sharpening Stone

Note. From *Chesapeakeknifeandcutlery.com*, Copyright 2007 by PAX River Enterprises. Retrieved November 19, 2007, from <http://www.chesapeakeknifeandcutlery.com/index.asp?PageAction=Custom&ID=49>

AXES

If the axe's cutting edge is chipped or misshaped from repeated honing, filing will be necessary. If the edge has the proper profile but is dull, honing is all that is required.

Filing an Axe Head

Placing the axe in a vice or clamp it securely to a work surface. Facing the axe head, hold the handle of the file with the right hand and the tip of the file with the left hand. Reverse if left handed. Thick leather gloves are

recommended for this procedure. File towards the edge at a 10-degree angle, moving from the top of the blade to the bottom. The file must bite only in the push movement and not to touch the axe when returning to the start position. Only remove enough material to shape the cutting edge. Once a side is done then turn the blade over in the vice and repeat the process.



Figure 8 Filing an Axe

Note. From “U.S. Department of Transportation Federal Highway Administration”, 2004, *An Axe to Grind: A Practical Ax Manual*,

Sharpening Using a Sharpening Stone and Honing Stone

With the axe in the vice, sharpen the edge using a sharpening stone. Use a circular motion starting from the top of the blade to the bottom. Make sure the stone remains in contact with the blade at the proper angle of 20 degrees. Finish sharpening with a honing stone and honing oil to polish the edge, using the same circular motion as with the sharpening stone.



The best way to keep an axe sharp is to use and store it properly. Do not stick it in the dirt or leave it in a tree. Always clean it after each use and apply oil to the blade. Always keep the original shape of the bit and the bevel. An axe that is given the wrong shape and bevel can bounce off the wood uncontrolled.

CONFIRMATION OF TEACHING POINT 2

The cadets' cleaning and sharpening of a knife and filing and sharpening an axe will serve as confirmation of this TP.

Teaching Point 3**Explain, demonstrate and have the cadets cut wood.**

Time: 20 min

Method: Demonstration and Performance



For this skill lesson, it is recommended that instruction take the following format:

1. Explain and demonstrate how to cut wood using tools skill while cadets observe.
2. Explain and demonstrate each step required to complete the skill. Monitor cadets as they imitate each step.
3. Monitor the cadets' performance as they practice the complete skill.

Note: Assistant instructors may be employed to monitor the cadets' performance.

SAFE WOOD CUTTING

An axe and a saw can be dangerous tools if mishandled. If the tools are in a poor condition—either dull, rusted or damaged—they should not be used. Using cutting tools requires proper attitude and concentration. Avoid using tools when tired or angry. Always be conscious of where the blade is.

Clothing

Avoid loose clothing, scarves or anything that may become entangled with the tool. Thick leather boots with steel toes are recommended.

Site

The site should be clear of ground obstructions and people. Overhanging branches should be trimmed away from the cutting site. Ensure all people know that wood is being cut and that they stay 10 m back. An axe held at arms length will indicate the minimum area that should be cleared for chopping. Cordon off the area used for chopping.

Inspect the axe before use. Do not use an axe if the head and handle do not line up straight, if the handle is split, chipped or otherwise damaged or broken, or if the head is loose. Never use a blunt axe as it can slip or bounce off wood uncontrolled.

Splitting Wood

Always use a chopping block below the wood to be chopped and do not let the axe go into the ground. The chopping block should be the largest round available and placed upright so the top surface is level and parallel to the ground.

Chop directly over the chopping block. The part to be cut should be resting at the centre of the chopping block and standing on its own.

Always stop when feeling tired, because there is a greater chance of missing and causing a serious injury.

Use an axe within a marked out chopping area. A bow saw is a safer tool to use away from the chopping area.

The chopping area is out of bounds for anyone not properly clothed or trained.

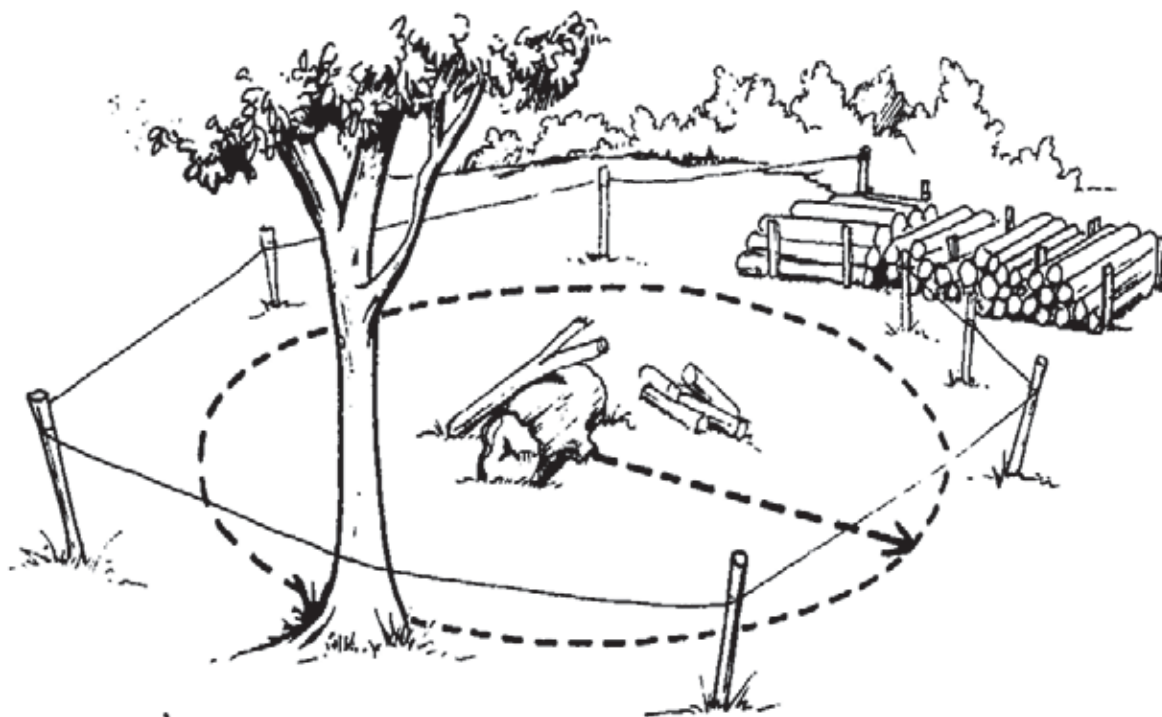

Figure 9 Chopping Area

Note. From [Scoutingresources.org/camping](http://www.scoutingresources.org/camping), Copyright 2007 by Scouting Resources.
Retrieved November 19, 2007, from http://www.scoutingresources.org.uk/camping_axe.html

USING AN AXE

On a Chopping Block



Before starting to use an axe, ensure that there is no one in the chopping area.

To chop wood with an axe:

1. Place a round of wood on the chopping block on its widest end, aligning the round so no knots face the person chopping.
2. Stand facing the chopping, legs spread shoulder width apart, the axe head centred on the chopping block at arms length.
3. Raise the axe above the head and bring it down onto the round. Let the momentum of the swing and weight of the axe do the work. To verify the distance from the block is correct, check the swing by chopping into the chopping block. Adjust the position as necessary.



To split larger logs, use a wedge and a mallet (as illustrated in Figure 15).

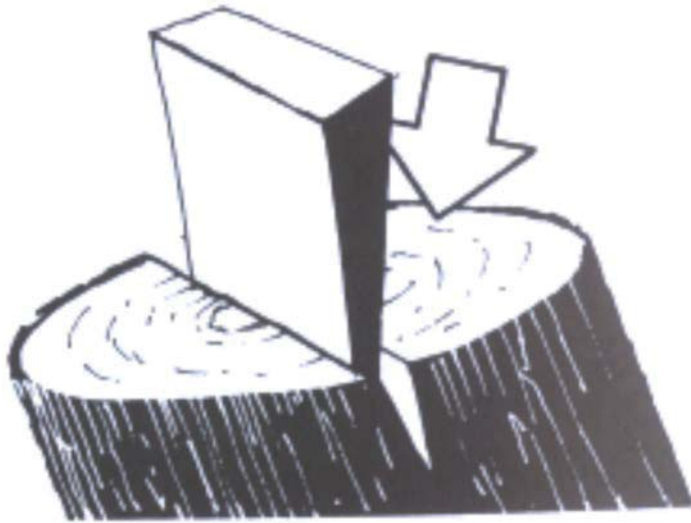

Figure 10 Wedge

Note. From *The SAS Survival Handbook* (p. 306), by J. Wiseman, 1999, Hammersmith, London: HarperCollins Publishers. Copyright 1986 by John Wiseman.

Cutting Logs



Before starting to use an axe, ensure that there is no one in the work area.

To remove branches, chop on the outside of the fork (as illustrated in Figure 11). Make sure to stand on the other side of the log to prevent injury (as illustrated in Figure 12). Always cut towards the tip of the tree.

To chop a log into shorter pieces, stand facing the log, feet wider than shoulder width, axe in hand, arm and axe length from the log. If is too close to the log, the axe head may pass over the log causing the axe handle to strike the log and break. If the person cutting the log is too far from the log, the axe head may strike the ground. Start the cut by striking the log a few times at a 45 degree angle left of the center of the cut. Create a V shape as wide as the log is round. Repeat this on the right side of the center of the cut. Alternate blows to either side of the cut. When possible, cut past the half way point, roll the log over and continue chopping from that side. The final blows should be done with caution as hitting the ground with the axe will dull it immediately.



Figure 11 Removing Branches 1

Note. From *The SAS Survival Handbook* (p. 306), by J. Wiseman, 1999, Hammersmith, London: HarperCollins Publishers. Copyright 1986 by John Wiseman.

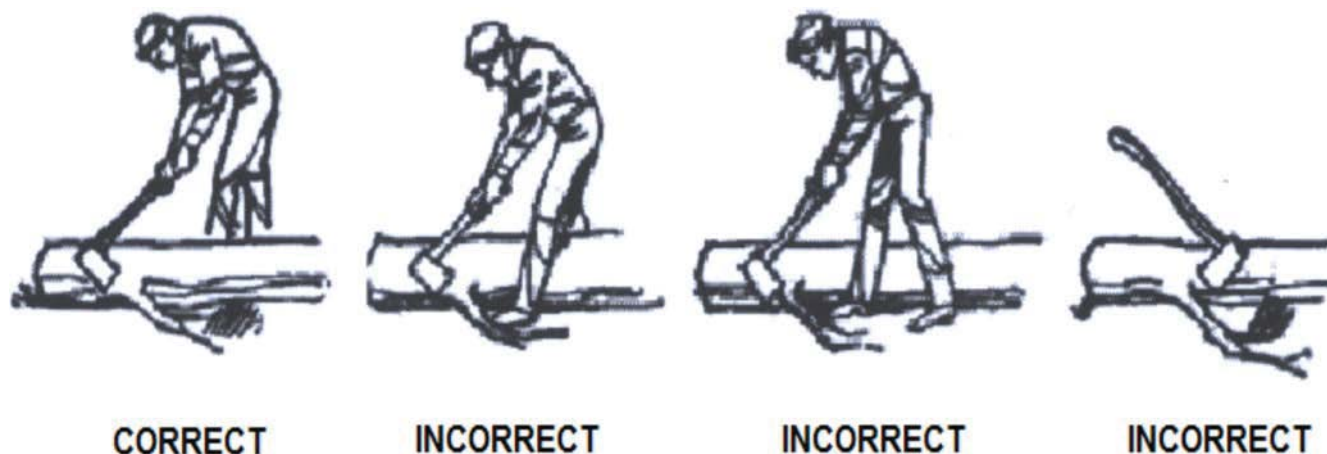

Figure 12 Removing Branches 2

Note. From [Scoutingresources.org/camping](http://www.scoutingresources.org/camping), Copyright 2007 by Scouting Resources. Retrieved November 19, 2007, from http://www.scoutingresources.org.uk/camping_axe.html



Figure 13 Log Chopping 1

Note. From *The SAS Survival Handbook* (p. 306), by J. Wiseman, 1999, Hammersmith, London: HarperCollins Publishers. Copyright 1986 by John Wiseman.

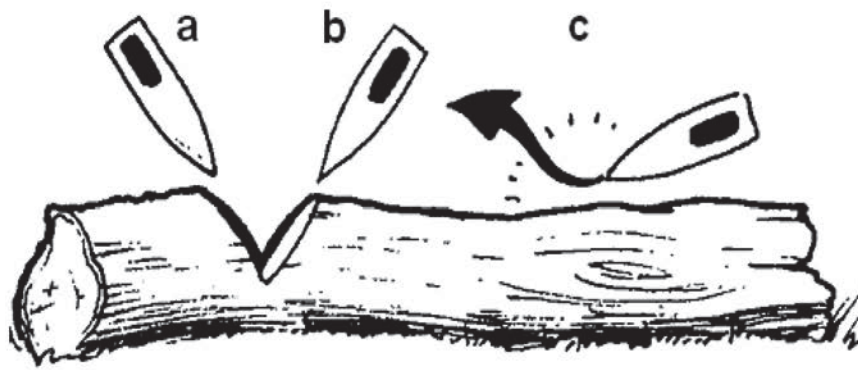

a. First few chops at 45 degrees.

b. Opposite angle chops at 45 degrees.

c. Wrong angle resulting in the axe bouncing off the wood.

Figure 14 Log Chopping 2

Note. From scoutingresources.org/camping, Copyright 2007 by Scouting Resources. Retrieved November 19, 2007, from http://www.scoutingresources.org.uk/camping_axe.html



Always look at the place the axe will hit. When practicing it is a good idea to put a chalk mark on the log and try to hit it.

After each swing make sure to look around and check for people close by.

Clear chippings away regularly and use them for kindling.

USING A BOW SAW



Before beginning, ensure that there is no one in the immediate area.

A bow saw is an efficient wood cutting tool when used properly. The wood being sawn must be supported so it cannot move. The saw should be held by one hand at the handle just above the blade. The other hand is placed at the top of the bow. The hand holding the handle supplies the power to the stroke. The upper hand guides the saw without applying any downward pressure.

To start the cut, place the saw blade where the wood is to be cut and pull the saw backward. At first it may be difficult to push and pull the blade as very few teeth are in contact with the wood causing the teeth to dig in. As the saw cuts deeper, it will be easier to push and pull as more teeth become supported by the wood. Avoid pushing down on the bow as this will cause the teeth to dig deep into the wood stopping the saw. Maintain rhythm while pushing and pulling. The teeth of the saw blade are set, meaning each tooth is alternately bent to the left or right of the blade. This removes chips wider than the blade preventing the saw from sticking in the wood. Ease up and slow down near the end of the cut.

The diameter of the piece of wood being cut should be less than half the length of the blade. This will allow the wood chips to be pushed clear the kerf (the width of the cut).

Avoid using one hand to hold the wood while sawing with the other. The wood being cut can be held down by a helper.



Always cover the blade of the saw after each use by using either a plastic 'clip-on' mask or tie a length of canvas around the blade.

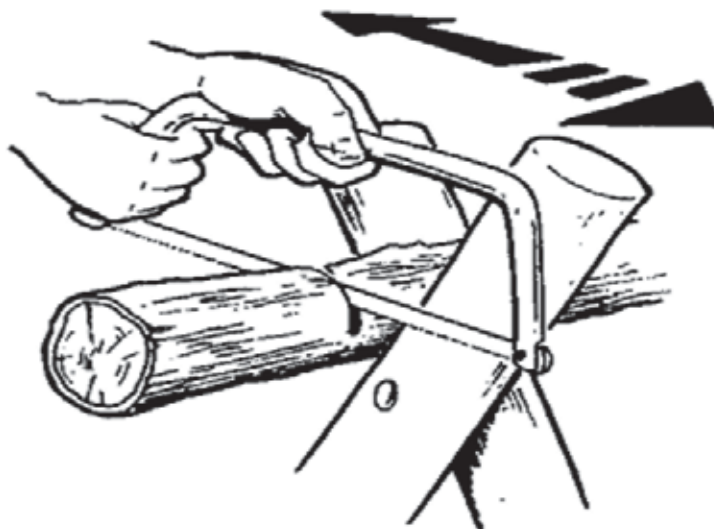

Figure 15 Cutting With a Bow Saw

Note. From scoutingresources.org/camping, Copyright 2007 by Scouting Resources. Retrieved November 19, 2007, from http://www.scoutingresources.org.uk/camping_axe.html

CONFIRMATION OF TEACHING POINT 3

The cadets' using an axe and a bow saw to cut wood will serve as the confirmation of this TP.

Teaching Point 4

Explain, demonstrate and have the cadets use a shovel.

Time: 15 min

Method: Demonstration and Performance



For this skill lesson, it is recommended that instruction take the following format:

1. Explain and demonstrate the complete skill while cadets observe.
2. Explain and demonstrate each step required to complete the skill. Monitor cadets as they imitate each step.
3. Monitor the cadets' performance as they practice the complete skill.

Note: Assistant instructors may be employed to monitor the cadets' performance.

Ensure that the area where the hole will be dug is marked. Areas with roots and rocks should be avoided.

DIGGING A HOLE

Place the tip of the shovel on top of the ground. The blade of the shovel should be vertical before digging into the ground. Place one foot on top of the shovel blade and while pushing down, rock the shovel from side to side. Once the blade of the shovel is in the ground pull back 45 degrees to free the soil. If the shovel will not pull back, reposition it around the hole. With one hand midway down the shovel shaft and the other at the top

using the leg muscles, lift the soil from the hole. Place the soil in a pile close to the hole. Continue to dig the hole until it is 30 cm deep into the ground.

FILLING THE HOLE

Holes that are no longer needed should be filled in. To fill the hole, push the blade of the shovel into the soil and then lift the soil into the hole. Repeat until the hole is filled. Pack the soil down to make the soil even with the rest of the earth. Sod should be replaced and the area groomed to remove all signs of the hole.

CONFIRMATION OF TEACHING POINT 4

The cadets' participation in using a shovel to dig a hole and to fill a hole will serve as the confirmation of this TP.

END OF LESSON CONFIRMATION

The cadets' practicing of safe toolcraft will serve as the confirmation of this lesson.

CONCLUSION

HOMEWORK / READING / PRACTICE

Nil.

METHOD OF EVALUATION

Nil.

CLOSING STATEMENT

It is important for the cadets to be able to use tools on an aircrew survival exercise. Tools support aircrew survival training by assisting in setting up a field exercise, erecting tents, starting fires. The cadets need to know how to safely use and care for tools to prevent accidents.

INSTRUCTOR NOTES / REMARKS

Sharpening should only be done under close supervision of trained staff members, to prevent unnecessary damage to the equipment and injury to cadets.

Cadets who are qualified Survival Instructor may assist with this instruction.

REFERENCES

C3-002 ISBN 0-00-653140-7 Wiseman, J. (1999). *The SAS survival handbook*. Hammersmith, London: HarperCollins Publishers.

C3-003 ISBN 1-896713-00-9 Tawrell, P. (1996). *Camping and wilderness survival: The ultimate outdoors book*. Green Valley, ON: Falcon Distribution.



ROYAL CANADIAN AIR CADETS
PROFICIENCY LEVEL FOUR
INSTRUCTIONAL GUIDE



SECTION 10

EO C490.05 – NAVIGATE A ROUTE USING A MAP AND COMPASS

Total Time:

120 min

PREPARATION

PRE-LESSON INSTRUCTIONS

Resources needed for the delivery of this lesson are listed in the lesson specification located in A-CR-CCP-804/PG-001, *Proficiency Level Four Qualification Standard and Plan*, Chapter 4. Specific uses for said resources are identified throughout the instructional guide within the TP for which they are required.

Review the lesson content and become familiar with the material prior to delivering the lesson.

Learning stations are a form of group work, where the cadets will be learning by demonstration and performance. When setting up learning stations, ensure that there is enough room for each cadet to be comfortable, and adequate space to work with the equipment. When cadets arrive at a learning station, all materials shall be available. These stations should be placed closely together to minimize time for movement; however far enough apart to avoid interruptions from other groups. For this lesson, four learning stations are required: one station for TPs 1 and 2 and one station each for TPs 3–5.

Based on the topographical map being used, create:

- a list of 10 conventional signs, to be used for TP 2;
- a list of 20 conventional signs for the cadets to determine four- and six-figure grid references (GRs), and a list of 20 four- and six-figure GRs for the cadets to determine the conventional signs, to be used for TP 3;
- two sets of GRs (one set for point-to-point and one set for along-a-route) for the cadets to measure distance on a map, to be used for TP 4;
- a set of GRs for the cadets to determine the bearing on a map, to be used for TP 4; and
- a 100-m straight flat course used to determine personal pace, to be used for TP 5.

A reconnaissance (recce) of the exercise area should be made to determine a site with several distinctive features to be used as prominent objects, to create a bearing course to be used for TP 5.

Create 4–6 three-leg map and compass courses to be used for TP 6. Each course will be listed as a set of four 6-figure GRs (the start point and the endpoint of each leg). Total length of each course should not exceed 2 km.

Determine a safety bearing in the event any groups become disoriented or lost.

PRE-LESSON ASSIGNMENT

Nil.

APPROACH

A practical activity was chosen for this lesson as it is an interactive way for the cadets to review the compass, topographical maps, GRs, distance on the map and on the ground, bearings on the map and on the ground, and to navigate a route using a map and compass in a safe and controlled environment. This activity contributes to the development of navigation skills and knowledge in a fun and challenging setting.

INTRODUCTION

REVIEW

Nil.

OBJECTIVES

By the end of this lesson the cadet shall navigate using a map and compass.

IMPORTANCE

It is important for cadets to navigate using a map and compass because it allows cadets another opportunity to practice skills learned in Proficiency Level Three.



Divide the cadets into four groups. Have the groups rotate between four learning stations: one station for TPs 1 and 2 and one station each for TPs 3–5. After the groups have been to all four stations, have them rendezvous at the designated location for TP 6.

Teaching Point 1

Review the compass.

Time: 10 min

Method: Practical Activity

BACKGROUND KNOWLEDGE

PRINCIPLES BEHIND THE WORKINGS OF A COMPASS

Regardless of intended purpose or complexity of construction, most compasses operate on the same basic principle. A small, elongated, permanently magnetized needle is placed on a pivot so that it may rotate freely on the horizontal plane. The earth's magnetic field, which is shaped approximately like the field around a simple bar magnet, exerts forces on the compass needle causing it to rotate until it comes to rest in the same horizontal direction as the magnetic field. Over much of the earth this direction is roughly running between north and south, which accounts for the compass's importance in navigation.

The earth has a north and south magnetic pole. These magnetic poles correspond roughly with the actual geographical poles. The north magnetic pole is located (2005 estimate) at approximately 82.7 degrees N latitude and 114.4 degrees W longitude, which lies over 800 km from the north geographic pole.

The horizontal force of the magnetic field, responsible for the direction in which a compass needle is oriented, decreases in strength as one approaches the north magnetic pole. This decrease is due to the lines of force changing direction towards the vertical as they bend back into the earth at the north magnetic pole towards the south magnetic pole. The compass starts to behave erratically, and eventually as the horizontal force decreases even more, the compass becomes unusable.

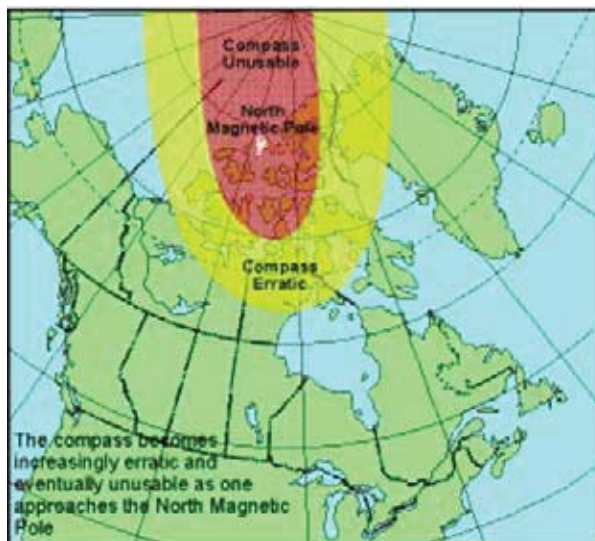

Figure 1 Earth's Magnetic Field

Note. From *Royal Canadian Army Cadet Reference Book* (p. 5-33), by Director Cadets 3, 2003, Ottawa, ON: Department of National Defence.

The nature of the earth's magnetic field is such that the magnetic north pole shifts geographic position about 5–10 km per year. Natural phenomena, like earthquakes, may also shift the magnetic field.

PARTS OF THE COMPASS

A - Sight. Located at the top of the compass cover. Used to align on an object when taking a bearing or to observe one along a given bearing.

B - Compass cover. Protects the compass dial and houses the sighting mirror.

C - Sighting mirror. Used to see the compass dial while taking a bearing.

D - Sighting line. Used when aligning an object or observing along a bearing.

E - Luminous index point. At the top of the compass dial and where a bearing is set or read from.

F - Compass dial. Houses the magnetic needle, the orienting arrow, the meridian lines, the declination scale (on the inside) and the dial graduations (on the outside).

G - Dial graduations. The compass dial is graduated in 2-degree divisions from 0 to 360 degrees. The dial is rotated by hand.

H - Orienting arrow. The black and red orienting arrow is located inside the compass dial and is used to line up with the magnetic needle when taking a bearing on the ground. The orienting arrow is what is adjusted when the magnetic declination is set.

I - Romer 1 : 25 000. Used to measure six-figure grid references (GRs) on maps with a 1 : 25 000 scale.

J - Compass base plate. A clear piece of flat plastic to which the cover, dial and lanyard are attached.

K - Declination scale. Used when adjusting the orienting arrow and while setting the magnetic declination for the map being used. It is graduated in 2-degree divisions.

L - Compass meridian lines. Black or red lines inside the compass dial. They are used to line up the compass dial with the grid lines (eastings) on a map.

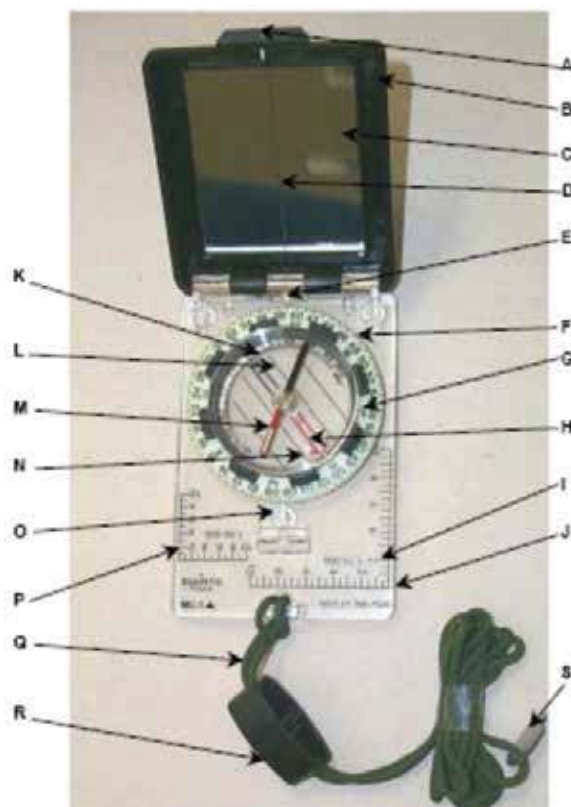

Figure 2 Compass

Note. From *Royal Canadian Army Cadet Reference Book* (p. 5-33), by Director Cadets 3, 2003, Ottawa, ON: Department of National Defence.

M - Magnetic needle. Spins freely and points towards magnetic north. The south end of the compass needle is black and the north end, with a luminous patch, is red.



When the magnetic needle is lined up in the red end of the orienting arrow, the mnemonic device "Red in the Bed" is used to remember that the red end of the needle belongs in the red end of the arrow.

N - Luminous orienting points. There are two luminous orienting points located on either side of the red end of the orienting arrow.

O - Luminous index point. At the bottom of the compass dial; where a back bearing is read from.

P - Romer 1 : 50 000. Used to measure six-figure GRs on maps with a 1 : 50 000 scale.

Q - Safety cord or lanyard. Used to fasten the compass to the wrist (never around the neck).

R - Adjustable wrist lock. Used to attach the compass to the wrist.

S - Screwdriver. Located at the end of the safety cord and is used to turn the screw to adjust the orienting arrow's position on the declination scale.

T - Declination adjusting screw. Located on the back side of the compass dial and is used to adjust the orienting arrow's position on the declination scale.

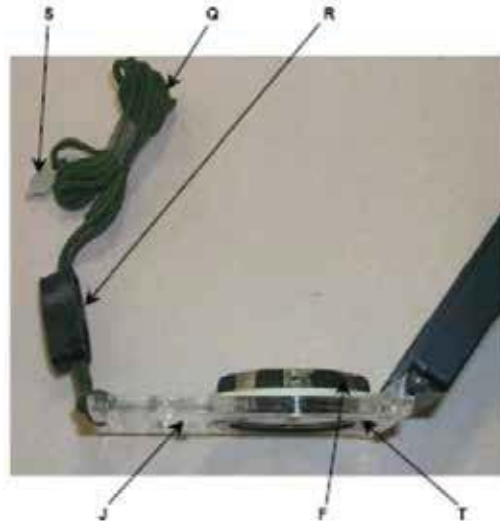

Figure 3 Compass

Note. From Royal Canadian Army Cadet Reference Book (p. 5-34), by Director Cadets 3, 2003, Ottawa, ON: Department of National Defence.



After being exposed to a strong light source, the luminous parts of the compass will glow in the dark making operating the compass at night possible.

HOW TO SET A PREDETERMINED DECLINATION

Declination

Magnetic declination is the difference in bearing either between grid north and magnetic north or between true north and magnetic north. Declination will change for each topographical map and it also changes annually due to the shifting north magnetic pole.



Cadets will almost always use the magnetic declination value between grid north and magnetic north (grid declination) when navigating using a map and compass. By setting the magnetic declination on the compass, magnetic bearings are converted to grid bearings which allow bearings taken from the map to be used on the ground and vice versa.

Declination is further described by stating whether the declination is east or west of magnetic north. The declination for the map being used is calculated using the information in the declination diagram (as illustrated in Figure 4) found in the marginal information of the map.



Declinations are stated in degrees and minutes. Each degree is subdivided into 60 minutes. This is important when setting the declination as the declination scale is graduated in 2-degree divisions.



Use diagram only to obtain numerical values
 APPROXIMATE MEAN DECLINATION 1982
 FOR CENTRE OF MAP
 Annual change (increasing) 4.4'

N'utiliser le diagramme que pour obtenir les valeurs numériques.
 DÉCLINAISON MOYENNE APPROXIMATIVE
 AU CENTRE DE LA CARTE EN 1982
 Variation annuelle (croissante) 4.4'

Figure 4 Declination Diagram

Note. From *Royal Canadian Army Cadet Reference Book* (p. 5-39), by Director Cadets 3, 2003, Ottawa, ON: Department of National Defence.

Adjusting the Declination on a Compass

The compass's declination scale must be set to compensate for the difference between grid north and magnetic north. To do this, first have the amount of declination in degrees east or west. Then, turn the compass over and look at the back of the dial.

From the zero point, using the screwdriver, turn the declination adjusting screw to the right for west and to the left for east declination (as illustrated in Figure 5). Each small black line represents two degrees of declination.



When setting declination on a compass, it is easier to hold the screwdriver and turn the compass, especially in cold weather. The declination shall never be turned past the last number of the declination scale.



Figure 5 Declination Scale and Screw

Note. Created by Director Cadets 3, 2008, Ottawa, ON: Department of National Defence.



If a person were to follow a compass bearing for 1 km without first adjusting for declination, for every one degree of declination, that person would be over 17 m to the left or right of their plotted bearing. This is how important declination is.

ACTIVITY

Time: 5 min

OBJECTIVE

The objective of this activity is to have the cadets name a part of the compass and describe its purpose.

RESOURCES

Compasses.

ACTIVITY LAYOUT

Nil.

ACTIVITY INSTRUCTIONS

1. Hand out the compasses to the cadets.
2. Ask the cadets to describe how a compass works.
3. Point to a part of the compass and have a cadet name it and describe its purpose.
4. Rotate through all the cadets.

SAFETY

Nil.

ACTIVITY

Time: 5 min

OBJECTIVE

The objective of this activity is to have the cadets set four different magnetic declination values on a compass.

RESOURCES

- Compasses, and
- Predetermined declinations, to include:
 - 8 degrees W,
 - 15 degrees E,
 - 3 degrees 30 minutes E, and
 - 9 degrees 45 minutes W.



When verifying the declinations set by the cadets, the line at the end of the orienting arrow should be:

- 8 degrees W: directly over the fourth graduated line to the left of the zero mark.
- 15 degrees E: halfway between the seventh and eighth graduated line to the right of the zero mark.
- 3 degrees 30 minutes E: three quarters of the way from the first towards the second graduated line to the right of the zero mark.
- 9 degrees 45 minutes W: to the right of and beside the fifth graduated line to the left of the zero mark.

ACTIVITY LAYOUT

Nil.

ACTIVITY INSTRUCTIONS

1. Review magnetic declination.
2. Give the cadets a declination value.
3. Have the cadets turn the compass over (on its back with the declination adjusting screw facing up).
4. Have the cadets grasp the screwdriver attached to the safety cord / lanyard.
5. Using the screwdriver, have the cadets turn the declination adjusting screw to the right for west and to the left for east declination values and set the given declination.
6. Check the set declination.
7. Have the cadets repeat Steps 2–6 for each of the predetermined declinations.
8. Have the cadets set the declination to zero before returning the compasses.

SAFETY

Nil.

CONFIRMATION OF TEACHING POINT 1

The cadets' participation in the activities will serve as the confirmation of this TP.

Teaching Point 2

Review topographical maps.

Time: 10 min

Method: Practical Activity

BACKGROUND KNOWLEDGE

MARGINAL INFORMATION

The margins provide information important to the understanding and use of the map. Before using an unfamiliar map, it is important to have a good look at the information contained in its margins. The layout and contents of the marginal information is normally in the same place for all topographical maps, but will always be found within the margins. This information includes:

Name of map sheet. For ease of reference, the name of the map is usually a major community or district located on the map (found at the bottom centre of the margin, as well as in the top or bottom right corner).

Number of the map and index of adjoining maps. A diagram showing the position of the map sheet in relation to adjoining sheets is shown near the lower right-hand margin. The diagram shows the sheet numbers of the adjoining sheets and accentuates the sheet in hand.

Date of map data. Helps to indicate the amount of change that may have occurred since the map was printed (found in the bottom left corner).

Map scale. Indicates the scale of the map, most commonly 1 : 25 000 or 1 : 50 000. Scale is used to represent distances on the map in direct relation to the ground. On a 1 : 50 000 scale map 1 cm on the map represents 50 000 cm (500 m) on the ground.

Scale bars. Used as a measuring aid for determining distance on the map (found bottom centre below the map name). The left end of the scale bars is divided into tenths for measuring distances more accurately.

Contour interval. Indicates the vertical (height) interval between contour lines and is given in metres or feet. The contour interval is found in the bottom margin.

Legend of conventional signs. A table showing the conventional signs used on the sheet in their correct colours with their descriptions is shown in the bottom or side margin, plus in a more complete list on the back of the map.

Military index number. The index is found in the top right corner of the map sheet and used for ordering additional maps.

Declination diagram. Contains the information for the map on how true, grid, and magnetic north relate to each other. This information is given in the form of a diagram with explanatory notes. The diagram is in the right side margin.

Universal Transverse Mercator grid system (UTM). The UTM grid system divides the earth's surface into zones, each covering six degrees of longitude and eight degrees of latitude. The 60 longitude bands are

numbered and the 20 latitude bands are lettered. Each grid zone is one rectangle of the grid pattern, established by the bands and designated by the figures of the longitude band followed by the letter of latitude band.

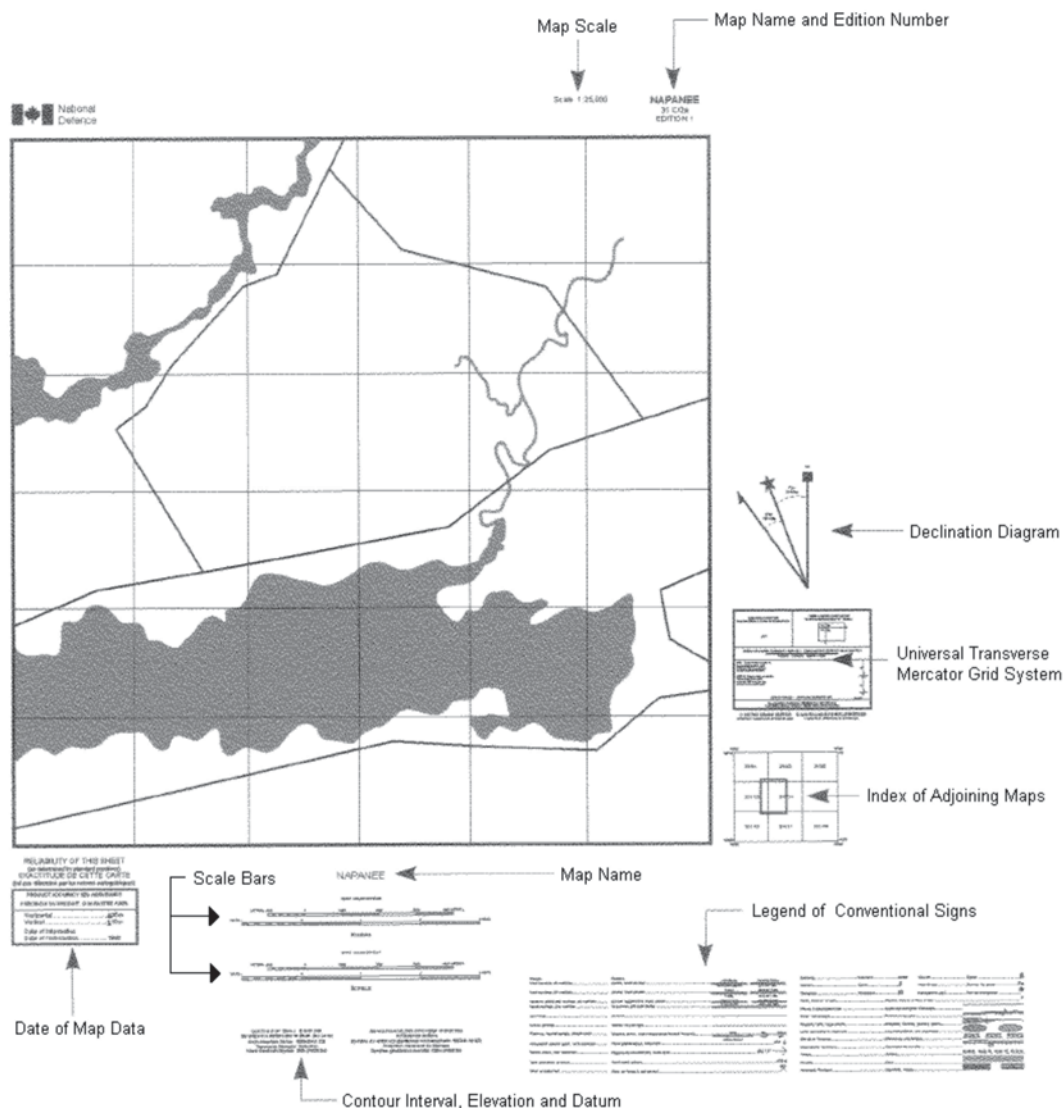

Figure 6 Marginal Information

Note. From *Maps, Field Sketching, Compasses and the Global Positioning System* (p. 11), by Directorate of Army Doctrine 8, 2006, Ottawa, ON: Copyright 2006 by Her Majesty the Queen in Right of Canada.

Military users, refer this map as:	SERIES A901 MCE 320 EDITION 1
------------------------------------	--------------------------------------

Figure 7 Military Index Number

Note. From *Maps, Field Sketching, Compasses and the Global Positioning System* (p. 12), by Directorate of Army Doctrine 8, 2006, Ottawa, ON: Copyright 2006 by Her Majesty the Queen in Right of Canada.

CONVENTIONAL SIGNS

A number of symbols are used to indicate an object or item of detail that cannot be shown either by outline or by a line symbol. Most have been established through long usage and standardization agreements. The meaning of most symbols is obvious. However, if there is doubt, consult the table of conventional symbols located on every map. Located on the back of most maps will be a chart listing many additional conventional signs.

Map-reading not only involves the ability to interpret the symbols shown on the map and to understand the information given in pictorial or written form, but it also involves a true understanding of the ground portrayed and an appreciation of the reliability and value of the particular map being used.

Where the symbol may have more than one meaning, the sign or symbol will be accompanied by a descriptive word (eg, tank or tower).

The use of colour aids in distinguishing details.

Red. Used to identify paved roads and highway numbers. Red is also used to shade in areas of urban development.

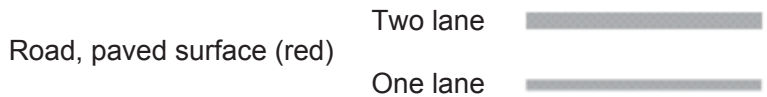

Figure 8 Red Conventional Signs

Note. Created by Director Cadets 3, 2008, Ottawa, ON: Department of National Defence.

Orange. Used to represent unpaved roads.

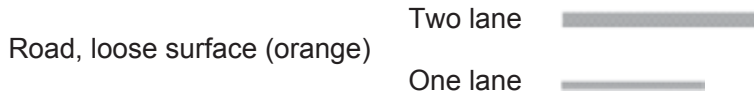
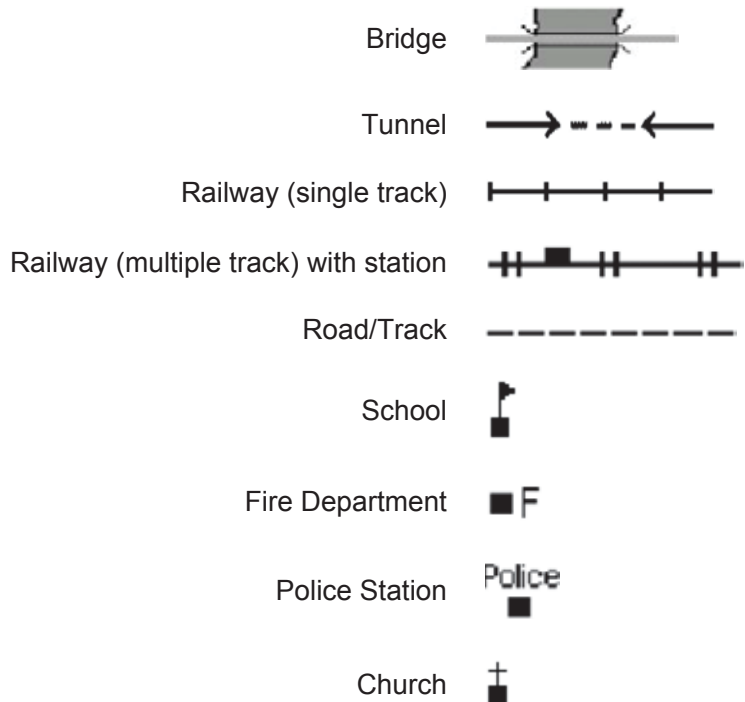

Figure 9 Orange Conventional Signs

Note. Created by Director Cadets 3, 2008, Ottawa, ON: Department of National Defence.

Black. Used for cultural features, toponyms (place names), some symbols and precise elevations.



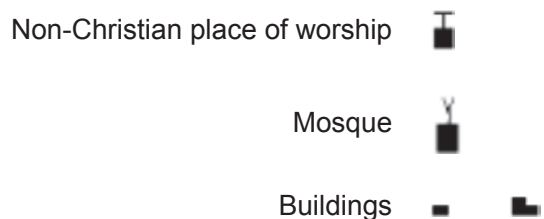

Figure 10 Black Conventional Signs

Note. Created by Director Cadets 3, 2008, Ottawa, ON: Department of National Defence.

Brown. Used for contour lines, contour elevations, spot elevations, sand, cliffs, and other geographical features.

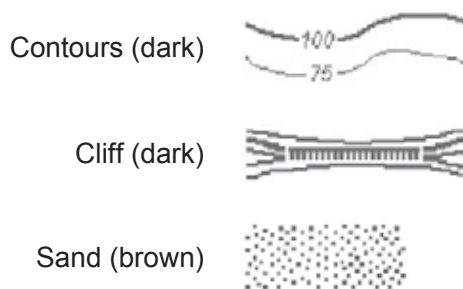

Figure 11 Brown Conventional Signs

Note. Created by Director Cadets 3, 2008, Ottawa, ON: Department of National Defence.

Blue. Used for water or permanent ice features (eg, rivers, lakes, swamps and ice fields), names of water features and the grid lines.

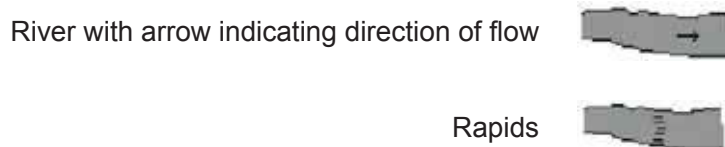

Figure 12 Blue Conventional Signs

Note. Created by Director Cadets 3, 2008, Ottawa, ON: Department of National Defence.

Green. Used for vegetation features such as woods, orchards and vineyards.

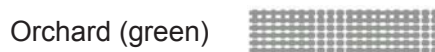

Figure 13 Green Conventional Signs

Note. Created by Director Cadets 3, 2008, Ottawa, ON: Department of National Defence.

White. Used to represent open fields.

Grey. Used for the legend of conventional signs on the back of the map.

Purple. Used for updates that are made over top of the original map information.

ACTIVITY

Time: 10 min

OBJECTIVE

The objective of this activity is to have the cadets locate marginal information and identify conventional signs on a topographical map.

RESOURCES

- Topographical maps, and
- List of conventional signs (as per pre-lesson instructions).

ACTIVITY LAYOUT

Large flat areas, preferably tables. If outside, use paperweights to hold down the maps.

ACTIVITY INSTRUCTIONS

1. Review the purpose of marginal information.
2. Review the purpose of conventional signs.
3. Have the cadets study the topographical maps.
4. Have the cadets locate the following marginal information:
 - a. declination diagram,
 - b. date of map data,
 - c. scale bars,
 - d. map name, and
 - e. contour interval.
5. Have the cadets locate conventional signs.

SAFETY

Nil.

CONFIRMATION OF TEACHING POINT 2

The cadets' participation in the activity will serve as the confirmation of this TP.



Send the group to their next learning station (only for the first three groups). If this is the last group, have them rendezvous at the designated location for TP 6.

Teaching Point 3**Conduct an activity to have the cadets review GRs.**

Time: 20 min

Method: Practical Activity

BACKGROUND KNOWLEDGE

FOUR-FIGURE GRs

Characteristics of a four-figure GR:

- Four-figure GRs will have four numerical digits derived from the numbers assigned to the eastings and northings on the map sheet.
- The numbers are listed by recording the two-digit easting followed by the two-digit northing.



The grid lines that intersect in the bottom left corner of the grid square are used to identify that grid square.

Steps to determine a four-figure GR:

1. Confirm the correct grid square.
2. Place a finger at the bottom left corner of the map.
3. Move that finger along the bottom of the map (left to right) up to the grid line (easting) before the grid square.
4. Record the two-digit easting.
5. Place a finger at the bottom left corner of the map.
6. Move that finger along the left side of the map (bottom to top) up to the grid line (northing) before the grid square.
7. Record the two-digit northing after the two-digit easting to create the four-figure GR.
8. Confirm the four-figure GR.

In Figure 14 Building A is located at GR 7433 and Building B at GR 7632.

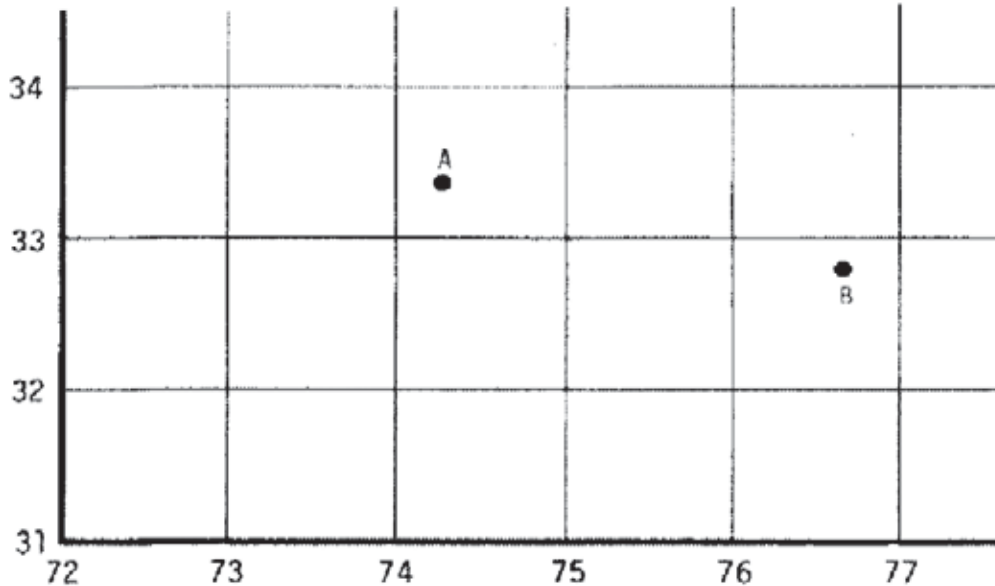

Figure 14 Four-Figure Grid References

Note. From Maps, Field Sketching, Compasses and the Global Positioning System (p. 37), Directorate of Army Doctrine 8, 2006, Ottawa, ON: Department of National Defence.

Steps to determine a grid square using a four-figure GR:

1. Confirm the four-figure GR.
2. Place a right-hand finger at the bottom left corner of the map.
3. Move that finger along the bottom of the map (left to right) up to the grid line (easting) numbered the same as the first two digits of the four-figure GR.
4. Place a left-hand finger at the bottom left corner of the map.
5. Move that finger along the left side of the map (bottom to top) up to the grid line (northing) numbered the same as the last two digits of the four-figure GR.
6. Move the right-hand finger up the grid line and the left-hand finger right along the grid line.
7. Where the two grid lines intersect is the bottom left corner of the grid square.
8. Confirm the correct grid square.

In Figure 14, GR 7532 represents the grid square southeast of Building A and west of Building B.

CONSTRUCTING A ROMER

Romer. A device used for measuring a point within a grid square to determine its six-figure GR.

Romers may be purchased or created. Purchased romers include compasses and protractors. Constructed romers use a small piece of paper and the scale bars of a topographical map.

Compass

Many compasses include romers already printed on the compass base plate. There are commonly two romers, for use with 1 : 25 000 and 1 : 50 000 scale topographical maps.

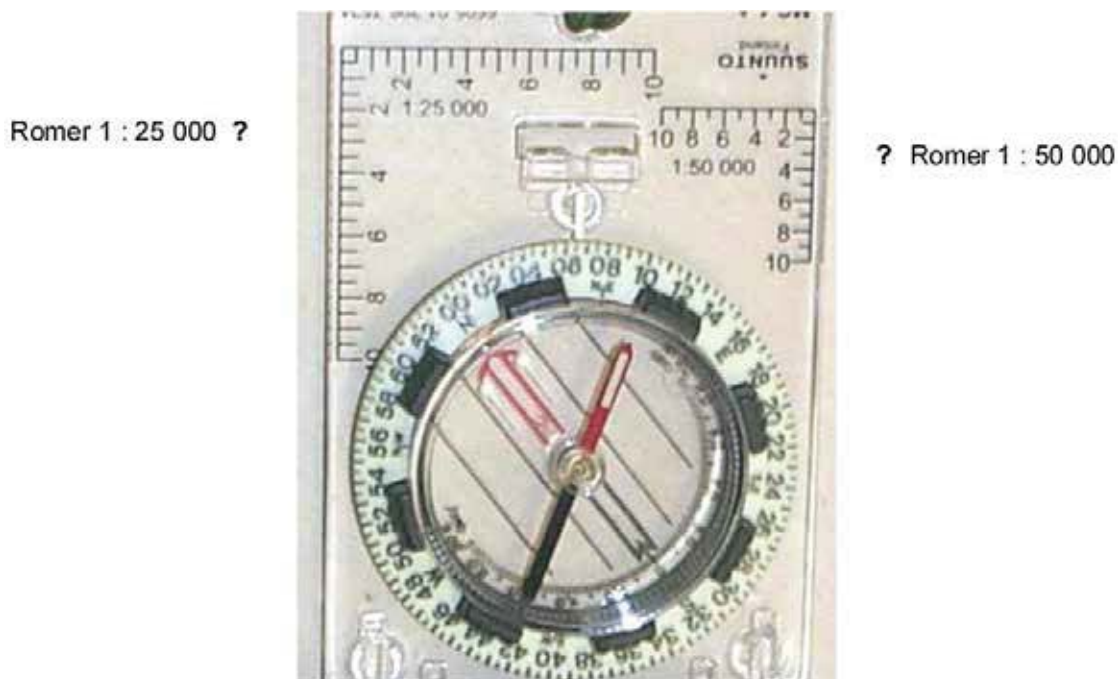

Figure 15 Compass

Note. Created by Director Cadets 3, 2008, Ottawa, ON: Department of National Defence.

Protractor

All protractors may be used to determine a bearing on a map, however, few have romers already printed on them. The Canadian Forces has created the C2 protractor (as illustrated in Figure 16) specifically designed for use on topographical maps.

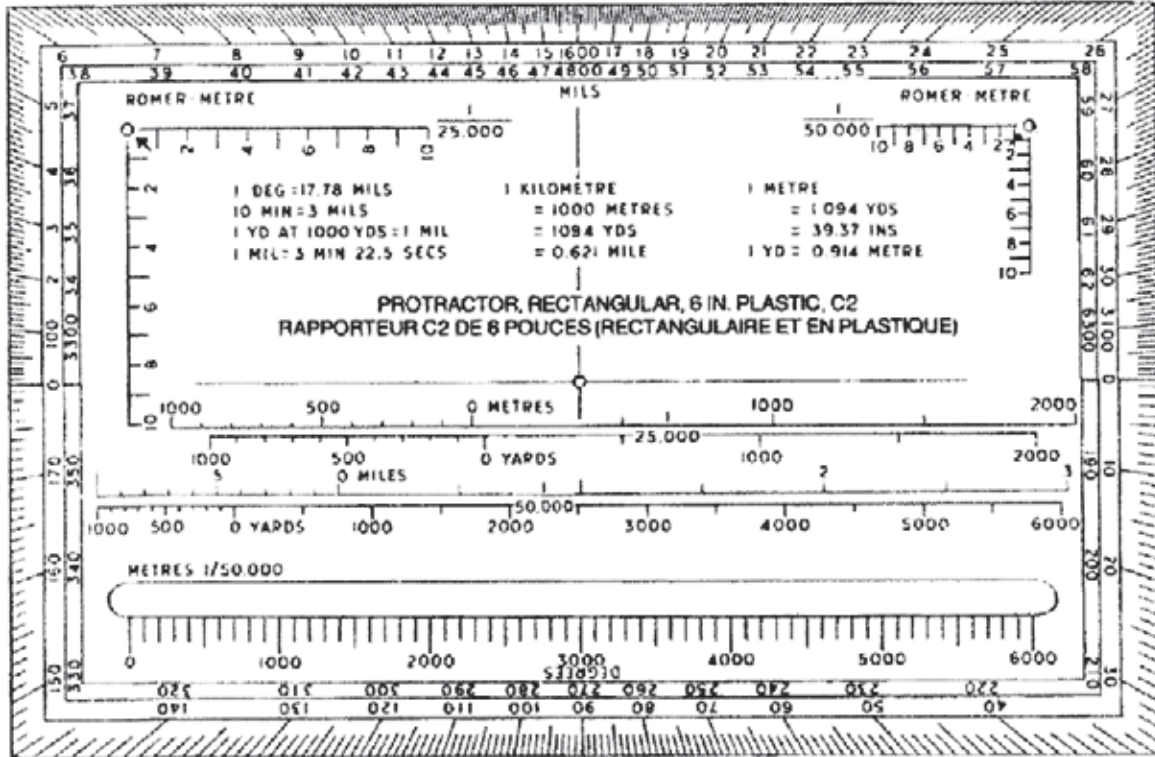

Figure 16 C2 Protractor

Note. From *Maps, Field Sketching, Compasses and the Global Positioning System* (p. 41), Directorate of Army Doctrine 8, 2006, Ottawa, ON: Department of National Defence.

Constructed

A constructed romer requires a piece of paper with at least one square corner and the scale bars of the topographical map. Using the scale bars of the topographical map, a romer can be constructed as illustrated in Figure 17.

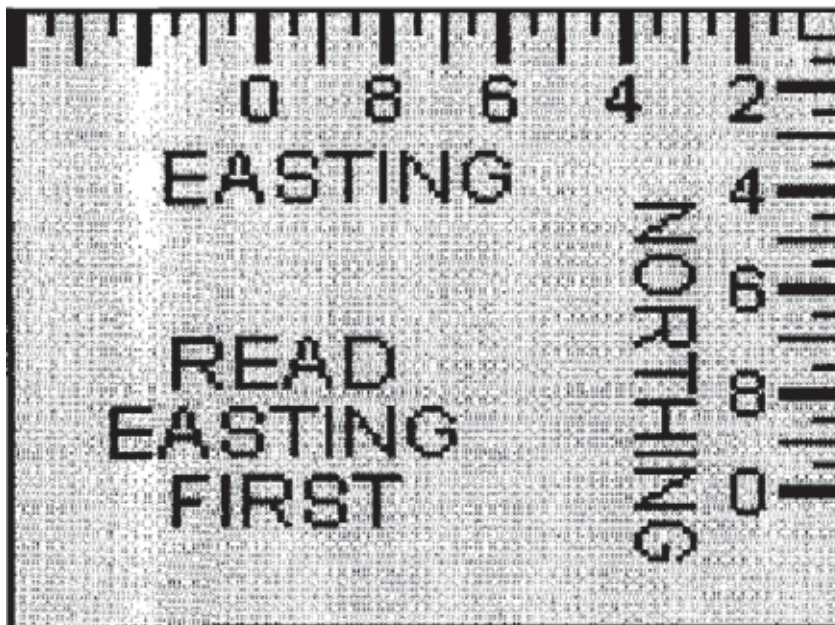

Figure 17 Constructed Romer

Note. From *Maps, Field Sketching, Compasses and the Global Positioning System* (p. 41), Directorate of Army Doctrine 8, 2006, Ottawa, ON: Department of National Defence.

Construct a romer for determining six-figure GRs by:

1. obtaining a blank piece of paper with a square edge;
2. placing one side of the square edge along the 100-m scale bars;
3. marking off 100-m segments beginning at the corner of the paper and working outward;
4. numbering these markings from zero (at the corner of the paper) to ten; and
5. repeating Steps 2–4 on the adjacent edge (eg, completed romer as illustrated in Figure 17).



It is important to use the correct scale bar. The constructed romer's markings should match the grid lines of the topographical map; the side of a grid square must be equal to ten 100-m marks on each of the romer's two edges.

SIX-FIGURE GRs

Determine a six-figure GR using a constructed romer by:

1. placing the corner of the constructed romer on the bottom left corner of the grid square, noting the four-figure GR;
2. moving the constructed romer to the right the number of tenths required to align the romer directly to or before (never past) the conventional sign or location for which the GR is being determined;

3. reading the value along the X-axis of the romer where it crosses the easting on the map sheet (the value at this intersection becomes the value for the third digit of the six-figure GR);
4. moving the constructed romer up the number of tenths required for the corner of the romer to be positioned on or before (never past) the conventional sign or location for which the GR is being determined;
5. reading the value along the Y-axis of the romer where it crosses the northing on the map sheet (the value at this intersection becomes the value for the sixth digit of the six-figure GR); and
6. combining the two sets of digits to create the six-figure GR.



Figure 18 Using a Constructed Romer

Note. From *Royal Canadian Army Cadet Reference Book* (p. 5-20), by Director Cadets 3, 2003, Ottawa, ON: Department of National Defence.

Determine what a six-figure GR represents using a constructed romer, by:

1. determining the four-figure GR, by removing the third and sixth digits from the six-figure GR, to identify and locate the correct grid square;
2. placing the corner of the constructed romer on the bottom left corner of the grid square;
3. moving the constructed romer to the right the number of tenths, as identified by the third digit;
4. moving the constructed romer up the number of tenths, as identified by the sixth digit; and
5. determining the object (that is up and to the right from the tip of the romer).

ACTIVITY

Time: 20 min

OBJECTIVE

The objective of this activity is to have the cadets determine four- and six-figure GRs and construct a romer.

RESOURCES

- Topographical maps,
- List of 20 conventional signs (as per pre-lesson instructions),
- Pens / pencils, and
- Paper.

ACTIVITY LAYOUT

Large flat areas, preferably tables. If outside, use paperweights to hold down the maps.

ACTIVITY INSTRUCTIONS

1. Have the cadets study the topographical maps.
2. Have the cadets determine the four-figure GR for each conventional sign.
3. Have the cadets determine the conventional sign of each four-figure GR.
4. Have the cadets construct a romer.
5. Have the cadets determine a six-figure GR for each grid square.
6. Have the cadets determine the conventional sign of each six-figure GR.

SAFETY

Nil.

CONFIRMATION OF TEACHING POINT 3

The cadets' participation in the activity will serve as the confirmation of this TP.



Send the group to their next learning station (only for the first three groups). If this is the last group, have them rendezvous at the designated location for TP 6.

Teaching Point 4

Conduct an activity to have the cadets review determining distance on a map and determining bearings on a map.

Time: 20 min

Method: Practical Activity

BACKGROUND KNOWLEDGE**DETERMINING DISTANCE ON A MAP**

Cadets can use a map to measure the distance between two points (eg, points A and B as illustrated at Figure 19) on the ground. All maps are drawn to scale; therefore, a specified distance on a map equals a specified distance on the ground. The scale of a map is printed at the top and bottom of each map (eg, scale 1 : 50 000). This means that 1 cm on the map equals 50 000 cm (500 m) on the ground.

There are two ways to determine distance on a topographical map—point-to-point and along-a-route.

Measuring Point-to-Point

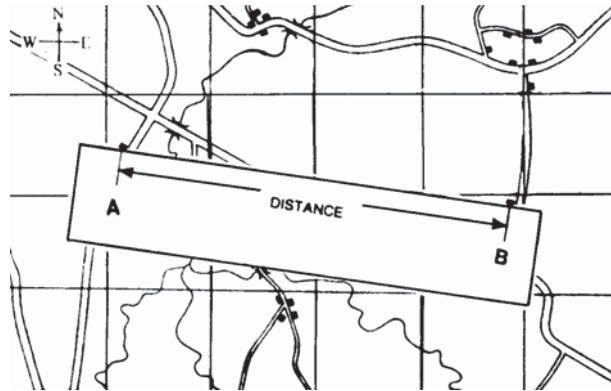

Figure 19 Measure Distance Point-to-Point

Note. From Royal Canadian Army Cadet Reference Book (p. 5-24), by Director Cadets 3, 2003, Ottawa, ON: Department of National Defence.

To measure a distance point-to-point:

1. Lay the straight edge of a piece of paper against the two points.
2. With a sharp pencil, mark the paper at the A (start) and B (end) points.
3. Lay the paper just under the metres scale bar with the B mark at the right end of the scale. Move the paper to the left, aligning the B mark with each thousand metre mark until the A mark falls within the subdivided thousands (hundreds) to the left of the zero.
4. To calculate the total distance, add the number of thousands where the B mark is, plus the number of subdivided thousands where the A mark is to the left of the zero.

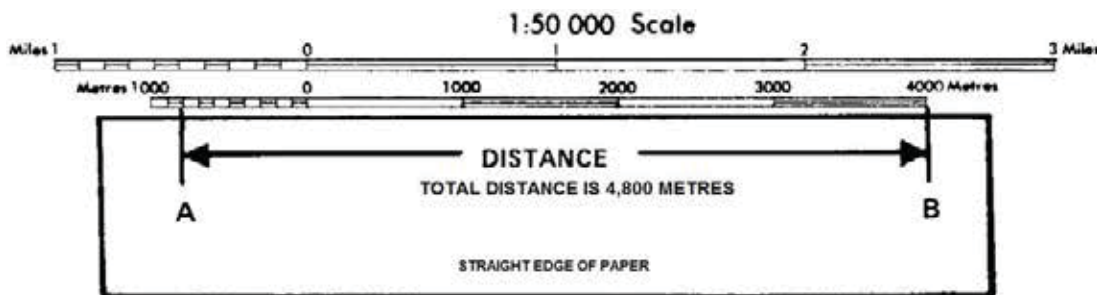

Figure 20 Calculate Distance

Note. From Royal Canadian Army Cadet Reference Book (p. 5-25), by Director Cadets 3, 2003, Ottawa, ON: Department of National Defence.



For a distance that is longer than 5 000 m, measure the first 5 000 m and mark the paper with a new line and label it '5 000 m'. Place the new mark at the zero or thousands mark until the A mark fits within the subdivided thousands (hundreds) bar. Add the total of that distance to the 5 000 m to create the total distance.

Measuring Along-a-Route Between Two Points

Sometimes cadets need to find the distance between A and B around the curves in a road along a planned route.

To measure a distance along a route between two points:

1. Lay the straight edge of a piece of paper against point A.
2. With a sharp pencil, mark point A on the paper and the map.
3. Line up the paper with the edge of the road until a curve is reached and make another mark on the paper and on the map.
4. Pivot the paper so that it continues to follow the road edge. Repeat until point B is reached.
5. Mark the paper and the map at point B.
6. Lay the paper just under the metres scale bar with the B mark at the right end of the scale. Move the paper to the left, aligning the B mark with each thousand metre mark until the A mark falls within the subdivided thousands (hundreds) to the left of the zero.
7. Add the number of thousands where the B mark is, plus the number of subdivided thousands (hundreds) where the A mark is to the left of the zero, to determine the total distance.

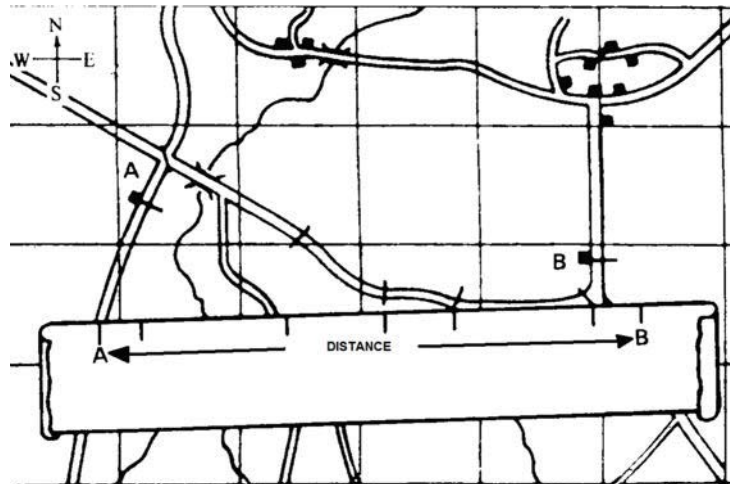

Figure 21 Measure Distance Along-a-Route

Note. From *Royal Canadian Army Cadet Reference Book* (p. 5-25), by Director Cadets 3, 2003, Ottawa, ON: Department of National Defence.

DETERMINING BEARINGS ON A MAP

In order to determine bearings on a map, the cadet needs to understand the points of a compass, the degree system, the three norths and types of bearings.

The 16 Points of a Compass



Figure 22 Compass Rose

Note. Created by Director Cadets 3, 2007, Ottawa, ON: Department of National Defence.

The four cardinal points of the compass, measured at right angles clockwise from north are:

- north (N) at 0 and 360 degrees,
- east (E) at 90 degrees,
- south (S) at 180 degrees, and
- west (W) at 270 degrees.

The four inter-cardinal points are located halfway between each of the cardinal points. Measured clockwise from north, they are:

- northeast (NE) at 45 degrees,
- southeast (SE) at 135 degrees,
- southwest (SW) at 225 degrees, and
- northwest (NW) at 315 degrees.

The eight intermediate points are located halfway between each cardinal point and inter-cardinal point. Measured clockwise from north, they are:

- north-northeast (NNE) at 22.5 degrees,
- east-northeast (ENE) at 67.5 degrees,
- east-southeast (ESE) at 112.5 degrees,
- south-southeast (SSE) at 157.5 degrees,

- south-southwest (SSW) at 202.5 degrees,
- west-southwest (WSW) at 247.5 degrees,
- west-northwest (WNW) at 292.5 degrees, and
- north-northwest (NNW) at 237.5 degrees.



As an aid to remember the different types of points:

- cardinal points are designated by one letter,
- inter-cardinal points are designated by two letters, and
- intermediate points are designated by three letters.

The Degree System

The cardinal, inter-cardinal, and intermediate points describe directions only to within one-sixteenth of a full circle. For a more precise indication of direction, it is necessary to use the sub-divisions of the circle called degrees. This measurement starts and ends at north (top) and is measured in a clockwise rotation.

Degrees. The most common method of dividing a circle is by degrees. These degrees represent 360 equal angles in a complete circle and they are represented by the symbol "°" (eg, 222°).



It is important to emphasize that degrees should always be measured clockwise and always using north as the start point.

The Three Norths

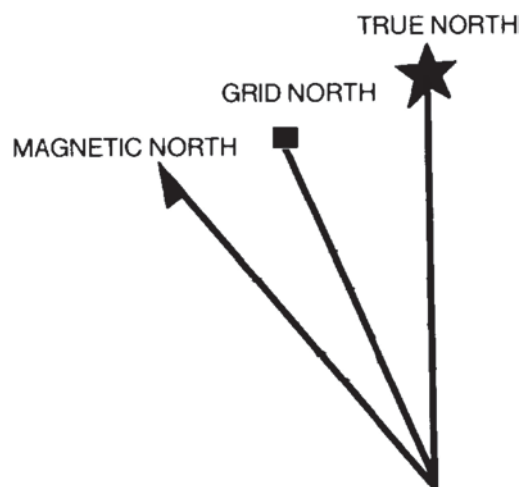

Figure 23 The Three Norths

Note. Created by Director Cadets 3, 2008, Ottawa, ON: Department of National Defence.

The relationship between the three norths, especially grid and magnetic, is key to using a compass on both a map and on the ground.

True north. True north is located at the top of the earth where the geographic North Pole is located, where all lines of longitude meet. In the declination diagram on the map, true north is represented by the symbol of a star, which represents the North Star, Polaris.

Grid north. Grid north is the north indicated by the grid lines (eastings) on a topographical map. The easting lines run parallel to each other and will never meet at the geographic North Pole; because of this, grid north points off slightly from true north. In the declination diagram on the map, grid north is represented by a square, which represents a map grid.

Magnetic north. Magnetic north is the location of the north magnetic pole, where the Earth's magnetic field bends back into the Earth toward the south magnetic pole. It is located in the Canadian arctic and is different from true north. It is the direction in which the compass needle points. In the declination diagram on the map, magnetic north is represented by a needle as on a compass.

The differences between the three norths affect navigation for the map and compass user, in the form of magnetic declination. Magnetic declination is the difference in bearing either between true north and magnetic north or between grid north and magnetic north.



Cadets will normally use the magnetic declination value between grid north and magnetic north when navigating using a map and compass. By setting the magnetic declination on the compass, magnetic bearings are converted to grid bearings which allow bearings taken from the map to be used on the ground and vice versa.

Types of Bearings

Bearing. A bearing is an angle that is measured clockwise, from north. It is measured in degrees and is relative to the observer.



In geometry, an angle is based on three points; a vertex, and two points, each of which designates a ray. For a bearing, the vertex is the point where the bearing is taken from, another point is north, and the last point is where the bearing is directed to. The north (either true, grid or magnetic) used identifies the type of bearing.

In ground navigation, one ray of the angle points north (usually grid north) and the other ray, known as a plotting ray, points to the object / direction.

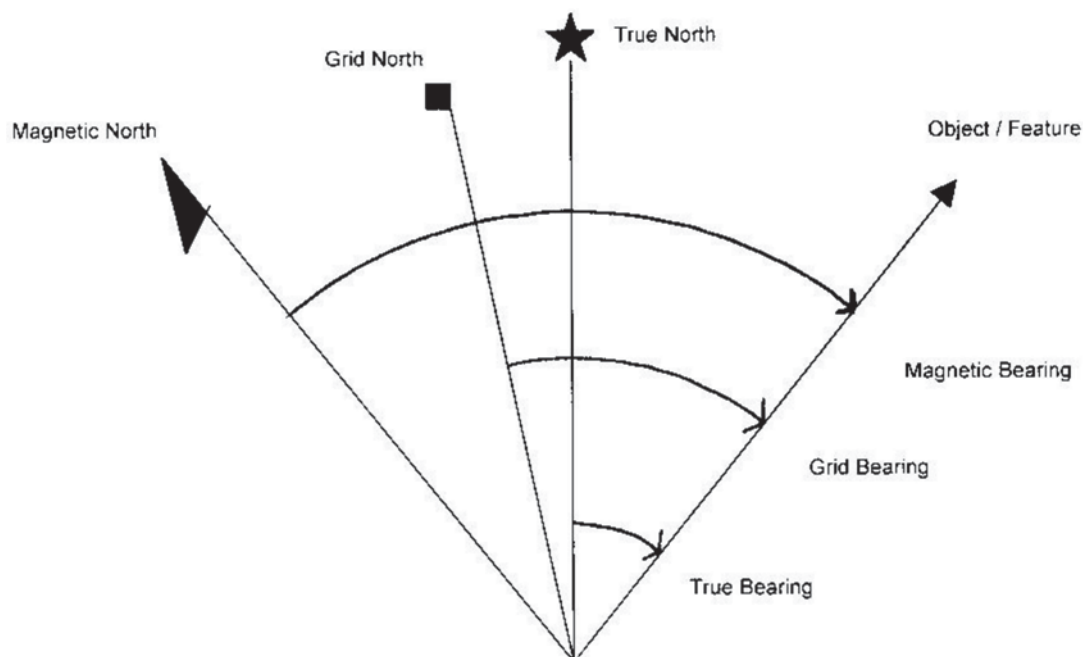

Figure 24 Types of Bearings

Note. Created by Director Cadets 3, 2008, Ottawa, ON: Department of National Defence.

True bearings. A true bearing is a bearing measured from true north. While map users rarely use them, directions determined using the sun, moon and stars are true bearings. Global Positioning System (GPS) receivers also use true bearings.

Grid bearings. A grid bearing is a bearing measured from grid north. The ability to determine a bearing from a map allows a map user to plan routes or activities before going into the field, and allows an easy method of communicating information about movement or location.

Magnetic bearings. A magnetic bearing is measured from magnetic north and is measured using a compass, which either has no option of setting magnetic declination or has the magnetic declination set to zero. A magnetic bearing is a quick and efficient method of describing a route when a map is not being used.



If a compass has its declination set to zero, bearings to objects on the ground determined by that compass are magnetic bearings. Setting the magnetic declination on a compass converts the magnetic bearings determined by that compass into grid bearings for the map being used.

Back bearing. A back bearing is a bearing that is in exactly the opposite direction of the bearing that has been measured. A back bearing can be useful for different reasons: to return to the start location after a hike, or to calculate the bearing from an object to one's current location. The steps to calculate a back bearing are:

- if the bearing is less than 180 degrees, add 180 degrees; and
- if the bearing is greater than 180 degrees, subtract 180 degrees.

ACTIVITY

Time: 20 min

OBJECTIVE

The objective of this activity is to have the cadets determine distances and bearings on a map.

RESOURCES

- Topographical maps,
- Sets of GRs for distances (as per pre-lesson instructions),
- Sets of GRs for bearings (as per pre-lesson instructions),
- Pens / pencils, and
- Paper.

ACTIVITY LAYOUT

Large flat areas, preferably tables. If outside, use paperweights to hold down the maps.

ACTIVITY INSTRUCTIONS

1. Have the cadets study the topographical maps.
2. Have the cadets determine the distance point-to-point on a map.
3. Have the cadets determine the distance along-a-route on a map.
4. Have the cadets identify the 16 points of a compass.
5. Have the cadets describe the degree system.
6. Have the cadets identify the three norths.
7. Have the cadets describe types of bearings.
8. Have the cadets determine a bearing on a map (as per created list).

SAFETY

Nil.

CONFIRMATION OF TEACHING POINT 4

The cadets' participation in the activity will serve as the confirmation of this TP.



Send the group to their next learning station (only for the first three groups). If this is the last group, have them rendezvous at the designated location for TP 6.

Teaching Point 5

Conduct an activity to have the cadets review determining distance on the ground and determining bearings on the ground.

Time: 20 min

Method: Practical Activity

BACKGROUND KNOWLEDGE

DETERMINING DISTANCE ON THE GROUND

Before distance can be determined on the ground, a method of measuring distance needs to be found. One such method is by determining one's own personal pace.

Determining a Personal Pace for 100 m

Being able to determine distance is a key skill for ground navigation. By learning how to determine distance using a personal pace, a cadet will have the skill to determine how far they have travelled, and how far they have to travel to reach their destination.

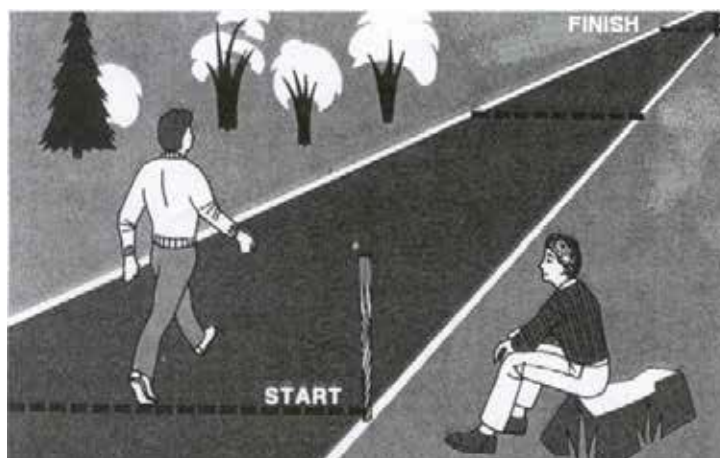

Figure 25 Determining Distance Using Pacing

Note. From *Be Expert With Map & Compass* (p. 53), by B. Kjellstrom, 1994, New York: Hungry Minds, Inc. Copyright 1994 by Bjorn Kjellstrom.

Personal pace. The number of paces a person walks over a distance of 100 m.

Counting Paces

There are two basic methods to count pace:

- count every pace (count every step); or
- count every other pace (count every left or every right step).

For example:

- count every pace: 140 paces = 100 m; or
- count every other pace: 70 paces = 100 m.

Calculating Distance

In order to determine distance travelled, the total number of paces travelled is divided by the personal pace and multiplied by 100 m to calculate the number of metres travelled.

Formula:

$$\frac{\text{total number of paces}}{\text{personal pace}} \times 100 \text{ m} = \text{total distance travelled (m)}$$

Example:

$$\frac{140 \text{ paces}}{70} \times 100 \text{ m} = 200 \text{ m}$$

Common methods of keeping track of the number of paces travelled include:

- transferring pebbles from one pocket to another: one pebble for each 100 paces;
- using a length of cord with knots—the knotted cord is held with the hand gripping a knot and the hand is advanced one knot down the cord for every 100 paces; and
- combining the knotted cord and pebbles (eg, cord with 10 knots, pebbles transferred for each completed cord [10 knots x 100 paces each = 1000 paces / pebble]).

Identifying Factors That Affect Pace

Factors that will affect personal pace include:

Terrain. The rougher the ground, the shorter the pace.

Slopes. Pace is shorter going uphill and longer going downhill.

Fatigue. Will shorten a person's pace.

Equipment. Footwear with poor traction will shorten a person's pace. Carrying a heavy load will also shorten a person's pace.

Weather. Snow and rain will shorten a person's pace. The wind will increase / decrease pace length if a person is travelling with / against the wind.

Obstacles. Going around small features (eg, trees, bushes) will affect pace count unless compensated for. Compensation methods include:

- **Sidestepping.** Stepping to the side (left / right) enough paces to bypass the obstacle, pacing forward past the obstacle and sidestepping back (right / left) to return to the original line of travel. This method maintains pace accuracy, but takes time.



The paces that the cadets sidestep are not added to their total pace count.

- **Alternating sides.** In this method, the cadet alternates which side (left / right) of the obstacle they pass (eg, last obstacle was passed on the left, next will be on the right). This method is less accurate, but faster.



If obstacles are always bypassed on the same side, the line of travel will veer off in that direction unless a distant steering point (eg, tall tree, hill top, building) is used as a guide.

DETERMINING BEARINGS ON THE GROUND

A compass can be used to determine the bearing for a direction of travel and from one's current location to a prominent object. The ability to take a bearing of a prominent object also allows the cadet to look for a prominent object as a steering point when they need to follow a given bearing. A bearing is a quick and accurate method for describing the direction of travel.



A prominent object is something that is usually tall and easily recognizable (eg, church steeple, tall tree or hilltop).



Figure 26 Determining a Bearing

Note. Created by Director Cadets 3, 2008, Ottawa, ON: Department of National Defence.



After the cadets have demonstrated the skill, have them practice determining the bearings of other prominent objects. This location should be predetermined by the recce IAW the pre-lesson instructions.

To determine the bearing of a prominent object:

1. Set the predetermined declination on the compass.
2. Hold the compass at eye level and at arm's length, and turn to face the prominent object (as illustrated in Figure 26).
3. Aim at the object using the compass sight, ensuring the sighting line is in line with the index pointer.
4. Adjust the compass cover so the compass dial is seen in the sighting mirror.

5. Look in the mirror and turn the compass dial until the magnetic needle is over the orienting arrow (put the red in the bed).
6. Read the number on the compass dial at the luminous index pointer.



Inform the cadets that when taking a bearing of a prominent object they will get different readings than other cadets unless they are all using the same line of sight to that prominent object (eg, standing in the same spot).

ACTIVITY

Time: 20 min

OBJECTIVE

The objective of this activity is to have the cadets determine distance on the ground and to determine bearings on the ground.

RESOURCES

- Compass, and
- Bearing course.

ACTIVITY LAYOUT

Pace course set up as per pre-lesson instructions. A bearing course with locations identified (spot to take bearing from and the prominent object / feature for which to take the bearing).

ACTIVITY INSTRUCTIONS

1. Have the cadets determine their personal pace using the pace course.
2. Have the cadets identify factors that affect pace.
3. Have the cadets determine bearings on the ground using the bearings course.

SAFETY

Nil.

CONFIRMATION OF TEACHING POINT 5

The cadets' participation in the activity will serve as the confirmation of this TP.



Send the group to their next learning station (only for the first three groups). If this is the last group, have them rendezvous at the designated location for TP 6.

Teaching Point 6**Have the cadets navigate a route using a map and compass.**

Time: 30 min

Method: Practical Activity

ACTIVITY**OBJECTIVE**

The objective of this activity is to have the cadets navigate a route using a map and compass.

RESOURCES

- Topographical map of the area,
- Predetermined magnetic declination,
- Set of four 6-figure GRs (the start point and the endpoint of each leg),
- Compass,
- Pencil, and
- Paper.

ACTIVITY LAYOUT

Four to six 3-leg map and compass courses, with the starting point for each course designated with a stake / marker.

ACTIVITY INSTRUCTIONS

1. Divide the cadets into groups of two.
2. Distribute a map, a compass, the predetermined magnetic declination, safety bearing, a set of four 6-figure GRs, a pencil and a sheet of paper to each group.
3. Brief the cadets on the activity, to include:
 - a. the purpose of the activity, and
 - b. safety.
4. Move the cadets to their start points.
5. Have the cadets complete their navigation exercise.
6. Have the cadets return their maps and compasses.

SAFETY

Nil.

CONFIRMATION OF TEACHING POINT 6

The cadets' participation in the activity will serve as the confirmation of this TP.

END OF LESSON CONFIRMATION

The cadets' navigating a route using a map and compass will serve as the confirmation of this lesson.

CONCLUSION

HOMEWORK / READING / PRACTICE

Nil.

METHOD OF EVALUATION

Nil.

CLOSING STATEMENT

Map and compass skills are important when training in a field setting. It allows groups to navigate within the training area in a safe manner. Survival training usually requires working within the bush away from the main exercise site. Understanding and practicing these skills allows the cadets to help plan survival training and organize routes between the main exercise site and the aircrew survival training areas.

INSTRUCTOR NOTES / REMARKS

TPs 1–5 are taught by learning stations. Divide the cadets into four groups and have the groups rotate between four learning stations: one station for TPs 1 and 2 and one station each for TPs 3–5.

To preserve and reuse the maps, they should be covered or coated with mac tac to allow the use of dry-erase markers instead of pencils or pens.

Assistant instructors and cadets who are qualified Survival Instructor may assist with this instruction.

REFERENCES

A2-036 A-CR-CCP-121/PT-001 Director Cadets 3. (2003). *Royal Canadian Army Cadet reference book*. Ottawa, ON: Department of National Defence.

A2-041 B-GL-382-005/PT-001 Directorate of Army Doctrine 8. (2006). *Maps, field sketching, compasses and the global positioning system*. Ottawa, ON: Department of National Defence.

C0-111 ISBN 978-0-9740820-2-8 Tawrell, P. (2006). *Camping and wilderness survival: The ultimate outdoors book* (2nd ed.). Lebanon, NH: Author.

C2-041 ISBN 978-0-07-1361101-3 Seidman, D., & Cleveland, P. (1995). *The essential wilderness navigator*. Camden, ME: Ragged Mountain Press.



ROYAL CANADIAN AIR CADETS
PROFICIENCY LEVEL FOUR
INSTRUCTIONAL GUIDE



SECTION 11

EO C490.06 – ERECT, TEAR DOWN AND PACK TENTS

Total Time:	120 min
-------------	---------

PREPARATION

PRE-LESSON INSTRUCTIONS

Resources needed for the delivery of this lesson are listed in the lesson specification located in A-CR-CCP-804/PG-001, *Proficiency Level Four Qualification Standard and Plan*, Chapter 4. Specific uses for said resources are identified throughout the instructional guide within the TP for which they are required.

Review the lesson content and become familiar with the material prior to delivering the lesson.

Additional instructors are required for this lesson to ensure TP 1 is covered in the time allotted.

PRE-LESSON ASSIGNMENT

Nil.

APPROACH

An interactive lecture was chosen for TP 1 to give direction on factors to consider when selecting a site.

A demonstration and performance was chosen for TPs 2 and 3 as it allows the instructor to explain and demonstrate erecting, tearing down and packing tents while providing an opportunity for the cadets to practice the skills under supervision.

INTRODUCTION

REVIEW

Nil.

OBJECTIVES

By the end of this lesson the cadet shall have the opportunity to erect, tear down and pack a two-section modular tent with walls and either an arctic tent or a civilian-pattern tent.

IMPORTANCE

It is important for the cadets to be able to use a modular tent because they are often used during aircrew survival exercises. A cadet's understanding of this lesson will allow them to better assist in the set-up of an aircrew survival exercise.

Teaching Point 1

Discuss site selection.

Time: 10 min

Method: Interactive Lecture

SITE SELECTION

When selecting a tent site on snow-covered ground, choose an area free from crevices. Prod the surface to ensure that a flat base is selected. The snow shall be removed until a firm base is exposed. The tent shall, if possible, be positioned so that its side is located downwind to avoid drifting snow blocking the entranceway.

When setting up an exercise site, it is important to know where to locate your sites for tents. There are factors to consider when doing this and they should be followed correctly as it is beneficial to everyone. The factors to consider are:

- Vehicle access for set-up and equipment transport.
- Inspecting the area for proximity to a water source that provides potable water and food from fishing.
- Inspecting for proximity to a fuel source for fire during cold weather.
- Inspecting for proximity to building materials.
- Inspecting proximity to animal trails and holes.
- Inspecting an entrance that is sheltered from the wind and preferably in the direction of the sun.
- Placing the tents away from the cooking area.

ACTIVITY

Time: 5 min

OBJECTIVE

The objective of this activity is to have the cadets find a site that is suitable for setting up tents.

RESOURCES

Nil.

ACTIVITY LAYOUT

Nil.

ACTIVITY INSTRUCTIONS

Have cadets, in pairs, find suitable sites for setting up tents.

CONFIRMATION OF TEACHING POINT 1

The cadets' participation in the activity will serve as the confirmation of this TP.

Teaching Point 2

Explain, demonstrate and have the cadets, as a member of a group, erect, tear down and pack a two-section modular tent with walls.

Time: 70 min

Method: Demonstration and Performance



For this skill, it is recommended that the instruction take the following format:

1. Explain and demonstrate each step in erecting, tearing down and packing a modular tent.
2. After demonstrating each step have the cadets perform the skill while monitoring their performance.

Note: Assistant instructors may be employed to monitor the cadets' performance.



If the modular tent is going to remain erected for the duration of the exercise, instruct tearing down and packing at the end of the exercise.

COMPONENTS OF A MODULAR TENT

A module of tent is comprised of a canvas section supported by tubular aluminum framework. It measures 2.5 m long by 5.5 m wide. The frame of a modular tent consists of two arch frames and three purlins (the horizontal beams along the length of the roof that support the canvas). The arch frame is hinged at the peak and the eaves. When folded the arch measures 2.75 m long. The purlins are 2.5 m long and connect two arches; one purlin at the peak and two more at each eave. They are locked into place without the use of tools. The framework is anchored with steel pegs which are inserted at the base of each arch and can be diagonally cross braced with cables or straps, between the eaves and base of the arches, to give an unobstructed inside space and an outside perimeter clear of guy wires. Guy wires are only used when the tent requires further reinforcement.

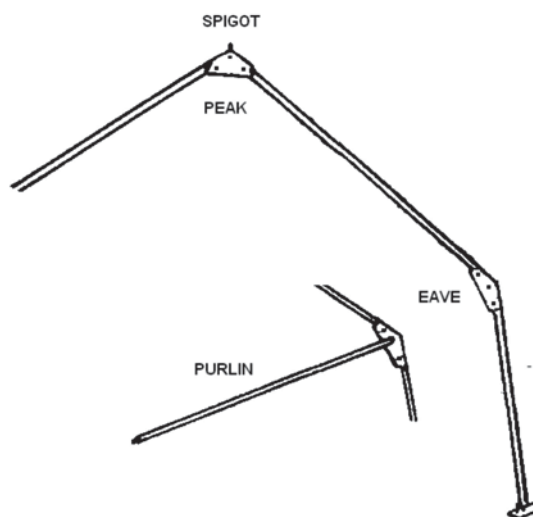

Figure 1 Frame

Note. Created by Director Cadets 3, 2007, Ottawa, ON: Department of National Defence.

TENT SECTIONS

The three tent sections are centre sections, front walls and rear walls. The tent sections attach to one another by means of a series of cord loops and grommets known as "Dutch lacing". The cord loops are on the opposite side of the grommets requiring all sections to be placed in the same direction. For example, all the cord loops on the right. Tent sections are made of olive green, core-spun, polyester-cotton, rip-stop woven material treated to be water-, rot- and flame-resistant. The sod cloth which extends 40 cm from the foot of each tent section is made from plastic-coated, waterproof material. The windows are screened and have blackout flaps and transparent vinyl panels which are attached with fastener tape (Velcro).

Centre section. This is the canvas roof and side wall covering of a module. It has a window in each side and a chimney opening in the roof.

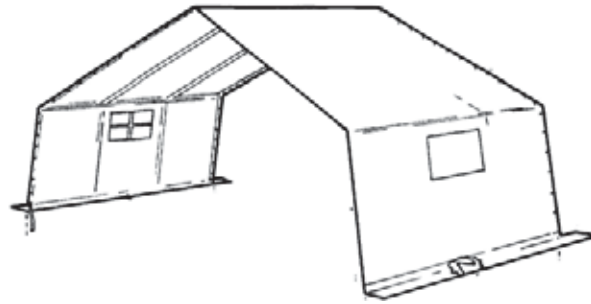

Figure 2 Centre Section

Note. From C-87-110-000/MS-000 *Operational Support and Maintenance Manual for Tent, Main*(p. 1-5), by DND Canada, 1983, Ottawa ON: Department of National Defence. Copyright 1983 by DND Canada.

Front wall. Attaches with grommets and opens with two zippered personnel doors. The front wall includes one window and a closable air vent.

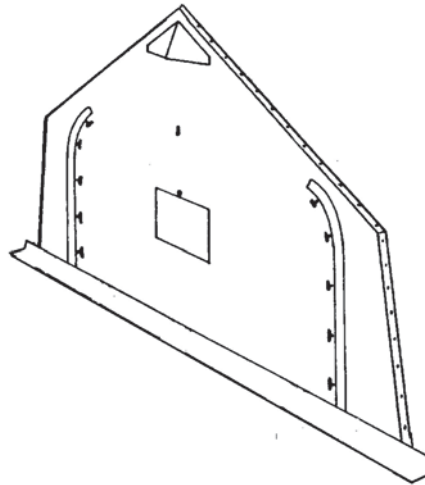

Figure 3 Front Wall

Note. From C-87-110-000/MS-000 *Operational Support and Maintenance Manual for Tent, Main*(p. 1-5), by DND Canada, 1983, Ottawa ON: Department of National Defence. Copyright 1983 by DND Canada.

Rear wall. Attaches with cord loops and opens in the centre. The opening reaches the peak of the module and is fastened with toggles, allowing access for large equipment. The rear wall includes two windows.

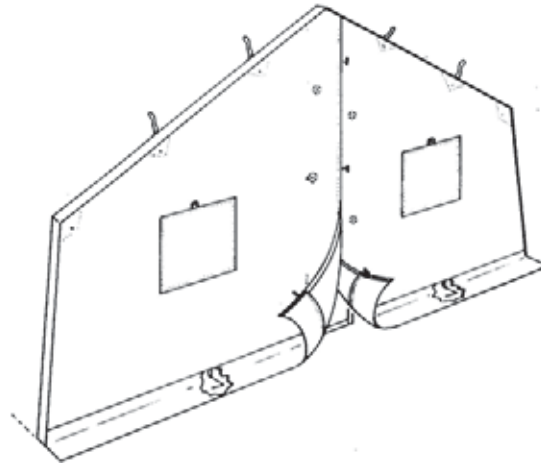

Figure 4 Rear Wall

Note. From C-87-110-000/MS-000 *Operational Support and Maintenance Manual for Tent, Main*(p. 1-5), by DND Canada, 1983, Ottawa ON: Department of National Defence. Copyright 1983 by DND Canada.

ACCESSORIES

Liners. The three common tent sections—centre section, front wall and rear wall—each have corresponding white fabric liners. These provide insulation as well as a light reflective surface, and are made from flame resistant material. The liners are suspended from inside the frame and are laced together similar to the tent sections.

Blackout hallway. Black fabric enclosure, 2.5 m long, attached inside the tent and laced to a grommet by the doorway, to prevent the entranceway from emitting light.

Lacing band. Provides the cord loops, to tie the two tent sections together when the module lacing sequence is disrupted because two grommet ends meet. It is 8.5 m long and 15 cm wide. A strap and a hooked shock cord are at each end to secure it to the frame and keep the band taut against the canvas.

Guy wires. Lines of cord that assist in securing the tent to the ground. Available for situations where the footings cannot be anchored in the ground or where the tent is subject to extreme windy conditions.

Bag tent. This is a flat canvas wrap specifically designed for containing tent sections. It includes a pocket to hold pertinent hardware.

Tools. A mallet, shovel and occasionally a stepladder. Tools are not included.

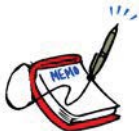

Explain tent maintenance to the cadets, but do not demonstrate or have the cadets perform.

TENT MAINTENANCE

The following precautionary measures, when followed, will protect the tent components from corrosion, mildew, rot and unnecessary damage and will work to prolong the life and usefulness of the tentage:

- Avoid folding or packing tent or liner sections when wet. Wet or damp tentage shall be unfolded and air dried within 48 hours.
- Protect tent and liner sections from petroleum and chemical stains. If soiling occurs, clean immediately with warm soapy water.
- Do not allow oil, mud or other foreign matter to gather or harden on frame components. Warm soapy water or cleaning solvents are recommended for cleaning. The components should not be lubricated.
- Do not leave collapsed tent sections and components in contact with the ground or exposed to the elements for more than 48 hours.
- All detected damage should be identified, reported and repaired at the earliest convenience.
- Dragging tentage on the ground, walking on tentage and general rough handling is prohibited.
- Effort shall be made to keep tentage equipment serviceable at all times and preventative maintenance practices must be employed during use.
- Erect and tear down tentage in accordance with the detailed procedures.



Explain, demonstrate and have the cadets perform each step in erecting, tearing down and packing.

ERECTING

Lay Out and Connect the Frame

Expand all arch frames leaving the legs in a folded position and space them in module increments using a purlin as a measure. Connect the purlins to each arch at the peak and eaves.

Lock the Frame

To operate the connecting, locking device on the peak bracket, first ensure the lock is released by:

1. placing the button head pin of the purlin into the bracket keyhole and push it upward in the keyhole slot;
2. moving the sliding bar up to allow the pivot lock to be swung over to hold the purlin in place;
3. moving the sliding bar down to lock the pivot;
4. operating the save bracket lock by lifting the sliding bar; and
5. releasing the arch frame leg from its erected state and moving down the lever lock, located inside the eave bracket.

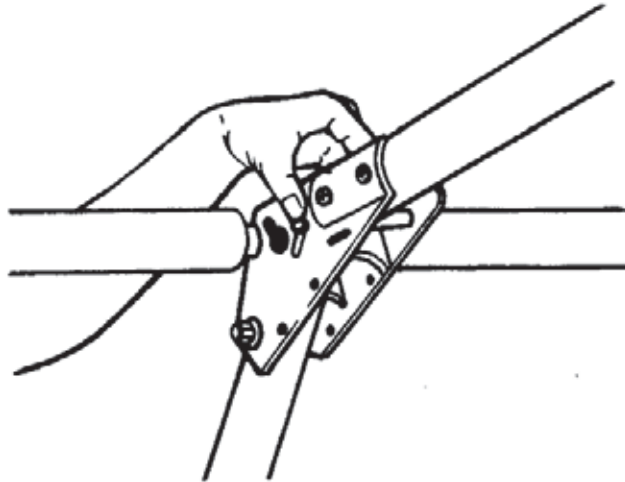

Figure 5 Frame Lock

Note. From C-87-110-000/MS-000 *Operational Support and Maintenance Manual for Tent, Main*(p. 2-5), by DND Canada, 1983, Ottawa ON: Department of National Defence. Copyright 1983 by DND Canada.

Connect Tent Sections

Identify the tent sections and position them so the front-rear sequence of lacing corresponds to the front and rear wall location. Lace the centre sections together using the dutch lace as follows:

1. Sandwich the grommet side between the flaps on the lacing side.

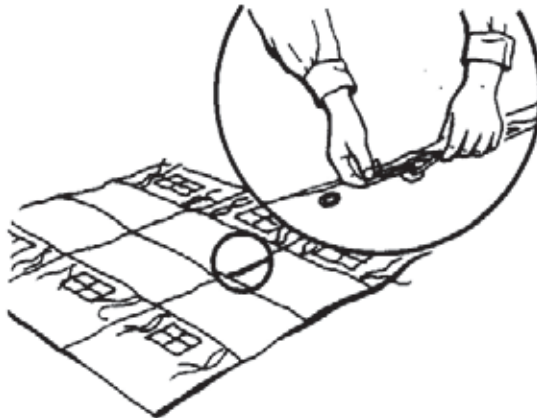

Figure 6 Canvas Lacing

Note. From C-87-110-000/MS-000 *Operational Support and Maintenance Manual for Tent, Main*(p. 2-8), by DND Canada, 1983, Ottawa ON: Department of National Defence. Copyright 1983 by DND Canada.

2. Pass the cord loops through the corresponding grommet holes and then through the next loop working from the centre outwards.

3. Tie off the last loop.

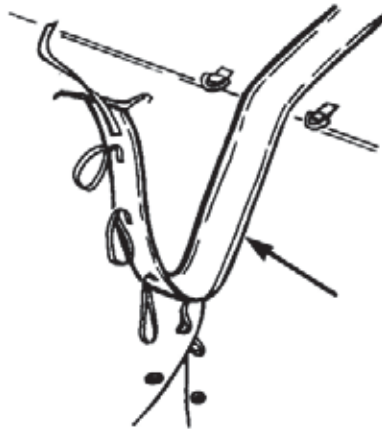

Figure 7 Canvas Lacing

Note. From C-87-110-000/MS-000 *Operational Support and Maintenance Manual for Tent, Main*(p. 1-8), by DND Canada, 1983, Ottawa ON: Department of National Defence. Copyright 1983 by DND Canada.

Raise the Side and Place Canvas

The following steps outline the procedure for raising the modular tent structure and placing the canvas:

1. Ensure the doors on the front and rear walls are closed. If the doors are left open they will be difficult to close after the modular tent is erected.
2. Raise one side of the frame with one person assigned to each arch frame. In windy conditions, temporarily secure the upright section to the ground with the tent pegs.



Figure 8 Erect One Side

Note. From C-87-110-000/MS-000 *Operational Support and Maintenance Manual for Tent, Main*(p. 2-8), by DND Canada, 1983, Ottawa ON: Department of National Defence. Copyright 1983 by DND Canada.

3. Place the previously folded canvas on the sloped side of the frame, positioning the master grommets (large holes at the peak of the canvas) over the frame spigots (large point at the peak of the frame), and then unfold the canvas onto the raised side.



Figure 9 Place Canvas

Note. From C-87-110-000/MS-000 *Operational Support and Maintenance Manual for Tent, Main*(p. 2-8), by DND Canada, 1983, Ottawa ON: Department of National Defence. Copyright 1983 by DND Canada.

4. Secure eave and foot straps on the raised side.
5. Attach the front and rear walls to the centre sections along the roof line only.
6. Raise the other side of the tent and align legs.
7. Attach save straps (straps on the underside of the canvas that attach to the purlins as illustrated in Figure 10) and bracing cables (support cables as illustrated in Figure 11) but do not tighten.

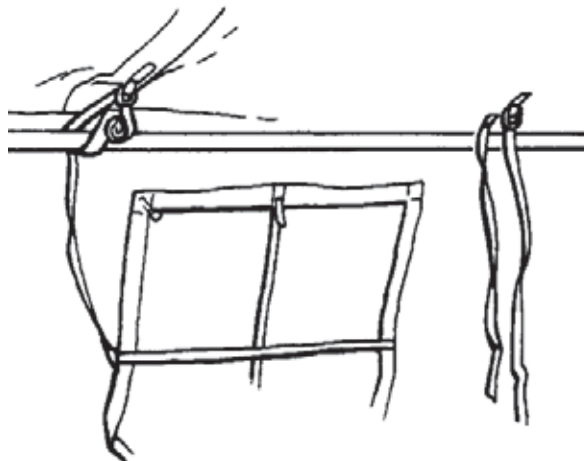

Figure 10 Save Straps

Note. From C-87-110-000/MS-000 *Operational Support and Maintenance Manual for Tent, Main*(p. 2-8), by DND Canada, 1983, Ottawa ON: Department of National Defence. Copyright 1983 by DND Canada.

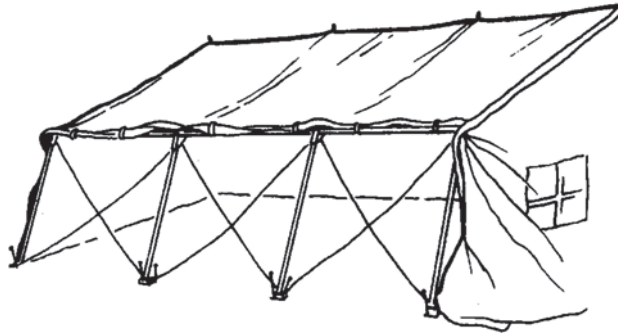

Figure 11 Bracing Cables

Note. From C-87-110-000/MS-000 *Operational Support and Maintenance Manual for Tent, Main*(p. 2-8), by DND Canada, 1983, Ottawa ON: Department of National Defence. Copyright 1983 by DND Canada.

8. Complete lacing the end walls to the centre sections.
9. Raise the other side and adjust the positioning and alignment of the arch legs to achieve a smooth canvas fit.

Anchor

The following steps outline the procedure for anchoring the modular tent to the ground:

1. Secure the frame to the ground. Hammer in the steel pegs (two per foot), working from the outside of the tent, so that the pegs are angled inwards (to prevent frame lifting as illustrated in Figure 12).

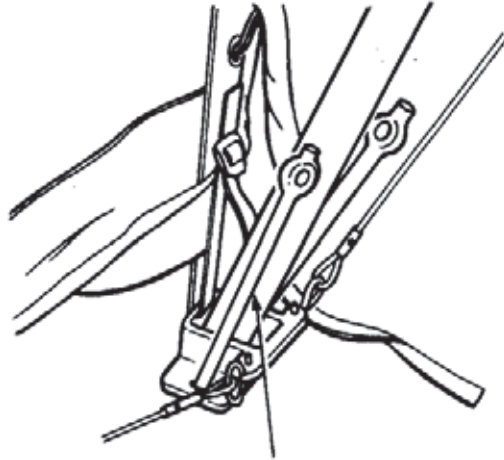

Figure 12 Drive in Pegs

Note. From C-87-110-000/MS-000 *Operational Support and Maintenance Manual for Tent, Main*(p. 2-8), by DND Canada, 1983, Ottawa ON: Department of National Defence. Copyright 1983 by DND Canada.

2. Tighten bracing cables or bracing straps to maximum tension.
3. Attach the foot strap, cinching to the maximum.
4. When using bracing cables, connect the vertical hold anchors with the corresponding D rings at the anchor points along the ground line of the canvas.

5. Drive the pegs into the ground under the sod cloth so that the side wall canvas is taut.
6. Connect the sod cloth flaps with the toggles and loops at the corners and along the sides. Place sod, snow or other suitable material on the sod cloths to prevent the wind from getting underneath them.



A trench is sometimes required when the tent is pitched on poor draining ground such as a flat, clay or heavy soil surfaces or shallow soil over bed rock. Sandy soils or areas which slope off normally do not require drainage trenches. The trench should be 20 cm wide by 15 cm deep. Slope the trench so that it drains away from the tent. Dig outlet drains at the lowest points of the trench, ensuring that they do not interfere with pedestrian or vehicular movement.



Only dig a trench if the situation requires.

TEARING DOWN

The reverse order for erecting is used to tear down a modular tent. The steps are:

1. Loosen the cables and ground anchors and remove (if wind is not too strong), otherwise leave until the tent is lowered.
2. Remove material from the sod cloth.
3. Release all straps and lacing up to the eave purlins.
4. Lower the tent one side at a time.
5. Unlace tent walls and sections and remove from frame.
6. Dismantle frame (reverse procedure).

Ensure that arrangements are made to clean and dry the equipment, if required, at the earliest opportunity.

PACKING



A diagram of the packing procedures is located at Attachment A.

To pack a modular tent, use the following steps:

1. Lay out the canvas with the outer surface facing the ground, for ease of cleaning.
2. Fold the front and rear walls by:
 - a. bringing the peak and sides of the wall toward the centre to square off the wall;
 - b. bringing the ends of the walls to the centre of the wall;

- c. folding the wall in half; and
 - d. folding the opposite way to complete the process; and
3. Fold the centre section by:
- a. taking the ends of the section and placing them in the centre of the section;
 - b. taking one end and folding it across to the other end;
 - c. taking the section and folding it into thirds;
 - d. folding the section in half; and
 - e. folding the section in half in the opposite direction.

CONFIRMATION OF TEACHING POINT 2

The cadets' participation in erecting, tearing down, and packing a modular tent will serve as the confirmation of this TP.

Teaching Point 3

Explain, demonstrate and have the cadets, as a member of a group, erect, tear down and pack an arctic tent or civilian-pattern tent.

Time: 30 min

Method: Demonstration and Performance



These descriptions and instructions will be given as the tent is being erected, torn down and packed.

If the tent is going to remain erected for the duration of the exercise, instruct tearing down and packing at the end of the exercise.

COMPONENTS OF A 5- OR 10-PERSON ARCTIC TENT

The 5- and 10-person arctic tents are bell-shaped with a pentagonal base. Each wall section of the pentagon has a snow flap attached to the bottom portion of its panel. The tent consists of an inner and an outer portion. The inner portion is most commonly used for cadet training and consists of a zipper door, base tie-down points, air vents, stove pipe openings and a reinforced apex for pole insertion. The tent is supported by a single telescopic centre pole and 16 (10-person) or 10 (5-person) guy wires. The guy wires are pegged down with lightweight alloy or plastic pegs.

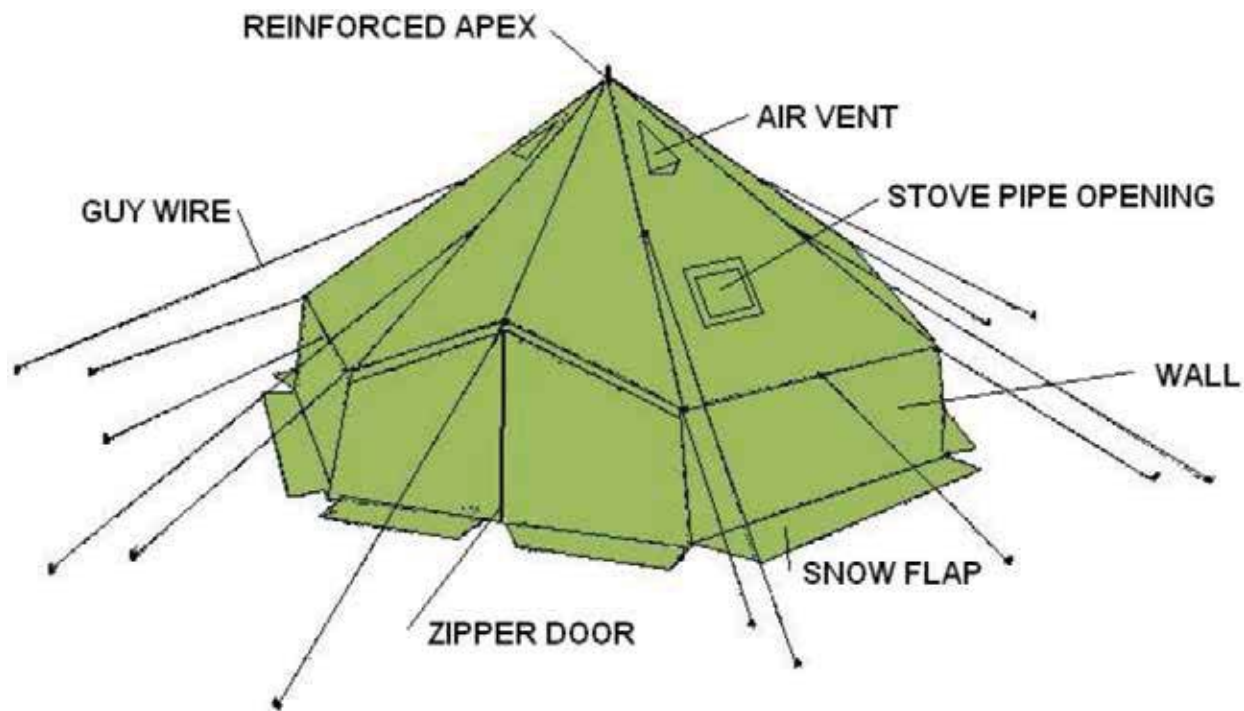

Figure 13 10-Person Arctic Tent Parts

Note. Created by Director Cadets 3, 2007, Ottawa, ON: Department of National Defence.



Figure 14 5-Person Arctic Tent

Note. From *Hero Army Surplus, Army Tents*, by heroarmysurplus.com, 2007. Copyright 2007 by heroarmysurplus.com. Retrieved December 2, 2007, from <http://heroarmysurplus.com/index.php/cPath/116?osCsid=jncvpsk59lech7i4chja975q6>



Figure 15 5-Person Arctic Tent Sleeping Arrangement

Note. From *B-GG-302-002/FP-001 Arctic and Sub-Arctic Operations, Part 1*(p. 3-11), by DND Canada, 1974, Ottawa ON: Department of National Defence. Copyright 1974 by DND Canada.



Figure 16 10-Person Arctic Tent

Note. From *Hero Army Surplus, Army Tents*, by heroarmysurplus.com, 2007. Copyright 2007 by heroarmysurplus.com. Retrieved December 2, 2007, from <http://heroarmysurplus.com/index.php/cPath/116?osCsid=jncvpsk59lech7i4chja975q6>

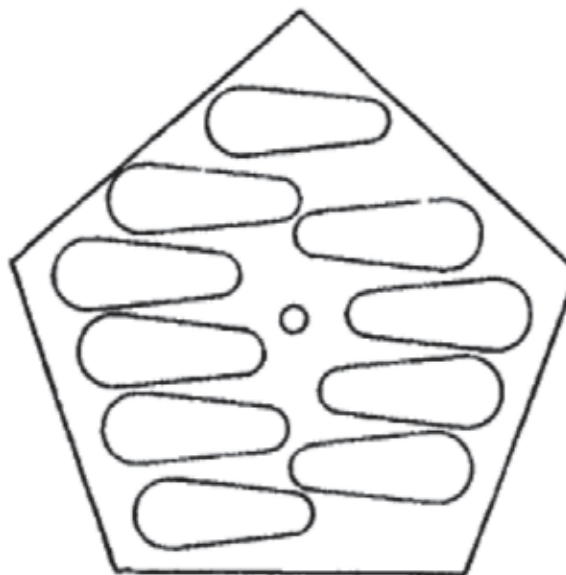

Figure 17 10-Person Arctic Tent Sleeping Arrangement

Note. From B-GG-302-002/FP-001 *Arctic and Sub-Arctic Operations, Part 1* (p. 3-12), by DND Canada, 1974, Ottawa ON: Department of National Defence. Copyright 1974 by DND Canada.

ARCTIC TENT INSPECTION

The tent must be inspected to ensure the following faults are not present:

- reinforced ring on apex damaged or torn;
- air vents are stuck closed or damaged;
- panels have tears, holes, broken threads or seams;
- guy wires or loops are either damaged or missing;
- broken or frayed guy wires or guy wire loops;
- stove pipe opening is damaged or missing;
- zipper on the outer door is broken;
- snow flaps with eyelets are torn away from the walls;
- drying line keepers are torn away from the seams;
- toggles are missing;
- telescopic pole (10-person tent) sections have bends or splits or the pole keeper pin is missing;
- tent pole (5-person tent) has bends or splits and do not fit together properly;
- base plate has cracks and, in the case of the 5-person tent, the base plate keep pin is missing; and
- pegs have broken points or bends.

ERECTING



Explain and demonstrate the following. Cadets may assist as necessary.

The only difference in erecting these two tents is the number of guy wires. On a 5-person arctic tent there are five wires and on a 10-person arctic tent there are 16. The following outlines the steps to take for erecting a 5- or 10-person arctic tent:

1. Choose a site for the tent (see TP 1 Site Selection).
2. Spread the tent out on the ground with the outside facing up.
3. Ensure the zipper is closed on the front door.
4. Check if the liner is in place; usually it is not in place in a new tent.
5. If the liner is not in place, follow these steps:
 - a. Spread out the liner above the tent with the inside of the tent facing up.
 - b. Attach the top and bottom stove pipe toggles of the liner to the tent.
 - c. Attach the remaining toggles of the liner to the tent. Use the corners of the tent as check points to make sure a toggle was not missed.
 - d. Thread the lower drying line through the drying line keepers.
6. Peg the corners of the arctic tent.
7. The tent pole will be folded in two. Straighten and lock it into position.
8. The individual (pole person) takes the pole and base plate under the canvas, going through the door and inserting it into the centre eye (reinforced apex) of the tent.
9. Secure the base of the pole onto the base plate and have the pole person hold the pole upright.
10. Before erecting the pole, drive the corner pegs into the ground.
11. Have the pole person extend the pole until the skirt and snow flaps are level with the ground. Use the pegs as a guide; they should be pulled out during this step.
12. The pole will have a shackle that needs to be lifted prior to extending. Be careful of the shackle pinching the pole person's fingers.
13. Lock the shackle into place to secure the height of the tent.
14. Pull on each of the lower guy wires and extend them in line with the seams of the tent.
15. Each guy wire will have an adjuster on it; make sure this adjuster is set to the middle position.
16. Peg the guy wires to the ground using heavy duty pegs.
17. Adjust the guy wires to remove any sag in the lower portion of the tent. The tent should be even in height all the way around.

18. Repeat Steps 14–16 with the upper guy wires. The tent guy wires should never cross with other tents.
19. Adjust and tighten all wires and prop up the door wire if necessary.
20. The two door eave wires can be propped up by placing the wire over an improvised pole, tree branch or other object higher than the door entrance. This keeps the doors from sagging and makes it easier to get in and out of the tent and gives the tent greater stability.

TEARING DOWN

Use the following steps to tear down an arctic tent:

1. Have the pole person enter the tent and hold the pole.
2. Pull out the pegs one at a time and roll up the guy wires and tie them off.
3. Have the pole person lower and remove the pole.

PACKING

Use the following steps to pack an arctic tent:

1. Lay out the tent with the tent door up and in the centre with zippers closed and remove any debris.
2. Make sure there are no double folds on the underside.
3. Hold the apex securely. The first long fold is made by folding the wings to the centre, with the pegs straight up and down.
4. Straighten and flatten out the arctic tent.
5. Fold in snow flaps across the base.
6. Make the second long fold, repeating the action for the first long fold.
7. Straighten and flatten out the arctic tent.
8. Make the third long fold, repeating the action for the first long fold.
9. Straighten and flatten out the arctic tent.
10. Make the fourth long fold by flipping the folds one on top of the other.
11. Make the first cross-fold; fold in the base to the top of the wall.
12. Make the second cross-fold by folding the apex into the base of the inserted pole section, allowing approximately 10 cm of loose fold at the base of the pole section to avoid wear and tear. The top of the pole should be offset.
13. Make the third cross-fold by placing the previous two folds one on top of the other.
14. Insert the tent, base plate and pegs into the bag.
15. Place the remaining two pole sections in the bag beside the tent.
16. Tie up the top of the tent bag.

SELECTING A CIVILIAN-PATTERN DOME TENT

To select a suitable civilian tent, consider the number of people it will need to accommodate, seasons during which it is being used, weather conditions that may be encountered, the weight of the tent and required features.

Seasons and Conditions

Three-season tents. Designed to offer good ventilation in the spring, summer, and fall, and provide sturdy weather protection in everything but heavy snowfalls and very high winds. Many three-season tents have mesh inner bodies, which reduce condensation, and can often be used without the fly for a cool, bug-proof shelter on hot nights. Three-season tents are airier, less expensive, lighter, more compact and roomier than four-season tents. Their versatility makes them popular with backpackers, paddlers, and cyclists.



Figure 18 Three-Season Tent

Note. From MEC Funhouse 4 Tent, by MEC.ca, 2007, Copyright 2007 by MEC.ca. Retrieved December 2, 2007, from http://www.mec.ca/Products/product_listing.jsp?FOLDER%3C%3Efolder_id=2534374302702837&bmUID=1196614958520

Four-season tents. Built to protect in extreme weather. They usually come with many poles and have low, curved shapes to shield high winds and reduce snow buildup. Extra guy wires provide more staking options. Fabrics tend to be heavier, with thicker waterproof coatings that make them more weatherproof, but less ventilated, and more susceptible to interior condensation. This additional protection means greater weight and packed size, and may be inappropriate for anything other than ski touring, winter camping, or mountaineering.



Figure 19 Four-Season Tent

Note. From MEC Mondarack Tent, by MEC.ca, 2007, Copyright 2007 by MEC.ca. Retrieved December 2, 2007, from http://www.mec.ca/Products/product_listing.jsp?FOLDER%3C%3Efolder_id=2534374302702837&bmUID=1196614958520

Weight

Tent weights are described as “minimum weight” and “packaged weight”. The minimum weight includes the tent and frame, and the fewest pegs and guy wires necessary to properly set up the tent. Packaged weight includes the full tent, instructions, stuff sacks, repair swatches, all guy wires and pegs. Conditions permitting, weight can be saved by leaving some pegs and components at home, and improvising with materials available at the site.

Features

Tent footprints. These are groundsheets that are custom-fit to the tent. Groundsheets protect tent floors from abrasions, increase waterproofness, and help insulate from the cool ground. Most tents have pre-made footprints, which are sold separately.

Vestibules. This is an excellent way to increase the liveability of a tent. They are useful for storing gear, to peel off wet clothing or put on boots. A pole-supported vestibule will be heavier, but generally larger and more storm-proof.

ERECTING

Setting up the Main Body

Use the following steps to set up the main body of a civilian-pattern dome tent:

1. Remove sharp objects that might puncture the tent floor. A footprint beneath the structure is not necessary for a waterproof tent, but it will reduce long-term wear on the tent floor.
2. Assemble all poles carefully.



Shock-corded poles (bungee cord) are meant to keep pole sections in the proper order, not as an automatic assembly mechanism for poles. Do not hold one section while whipping the rest of the pole back and forth, or toss the poles into the air; either procedure excessively stresses the pole joints and shock cord. Instead, fit poles together section by section, making sure that each piece slides completely into the next. Forcing an improperly assembled pole can damage the pole and / or the tent body and fly.

3. Lay the tent body flat. In windy conditions, peg all the floor corners before proceeding.
4. Lay the poles on top of the tent body so that each one crosses diagonally from one corner to the opposite corner; the two poles should cross in the centre to form an X.
5. Attach the pole clips to the canopy.
6. Fit the pole ends into the grommet tabs at the four corners of the tent.



Have one person lift the top of the tent to loft it up as the tension can cause the other poles to pop out. This is the stage when the greatest stress can be placed on the poles. There is often more than one grommet on each webbing tab to increase or decrease the tautness of the tent to compensate for fabric slackening or tightening caused by changes in humidity. When first erecting the tent, it is best to use the outermost (loosest) grommet on each tab.

7. Starting at a point over one of the doors, attach the clips on the tent to the poles.
8. Peg out the corners of the tent.



Most tents are colour-coded to help users put them up easier.

Attaching the Fly

1. Drape the fly over the tent so that the doors in the fly line up with the doors in the canopy.
2. Attach the Velcro wrap-ties to secure the fly onto the poles. They are usually on the underside of the fly on most tents. Attaching these wrap-ties is very important for strengthening the tent. The wrap-ties allow the poles to reinforce one another in a series of trusses; they also connect the corner guy wire attachment points directly to the poles for maximum stiffness when these guy wires are rigged.
3. Fit all of the grommet tabs on the fly over the appropriate pole ends.

Staking and Guying Out the Tent

Attach, peg out, and tension the four corner guy wires. Rather than thick, heavy poles for strength, most tents employ light, sturdy guy wires as part of their structure. This keeps the tents weight low. The design also makes it very important to securely rig the guy wires in any amount of wind. Not doing so could cause the tent to move in the wind (as with any tent, shelter from trees, rock, or snow walls will make for a quieter night under stormy conditions).



The pegs included with a tent are suitable for general use on relatively soft ground. On very hard-packed ground, use stakes that can withstand the force needed to secure them. On snow, sand, or other loose-packed surfaces, wider T-stakes or aluminum snow stakes will hold better; these stakes hold best buried horizontally. Improvise with other stakes (hiking staffs, ice axes, branches, rocks, trees), using the tents stake loops or cord as required.

Ventilating the Tent

Proper ventilation is the key to minimizing condensation in any tent. Some points to consider are:

- Keep fabric doors open as widely as the prevailing weather permits.
- If bugs are not a problem, leave mesh doors open.
- Open each door from the top down; warm, moist air rises and will escape through high openings.
- If the design of the tent allows, open it at either end or both sides to allow air to flow through.
- On very hot nights, when there will be no rain or dewfall, leave the flysheet off and use the inner tent to keep out bugs.

TEARING DOWN AND PACKING

The most important consideration in taking down a tent is not to stress the poles and fabrics by following these steps:

1. Disconnect guy wires and release the tension from the tent.
2. Release all the poles. If the tent has pole sleeves, push the poles out of the sleeves instead of pulling them out.
3. To minimize the stress on the bungee cord in the poles and to speed disassembly, fold each pole in half first, and then fold down towards the outsides, two sections at a time.
4. Make sure to remove all of the components from one another prior to storing. A wet tent should be dried prior to packing as the moisture will damage the tent over time.
5. If possible, fold and roll the tent rather than stuffing it into its sack. Rolling makes a smaller package, and causes fewer creases in the polyurethane coating. The tent and poles may be carried separately for easier packing or load sharing.

MAINTAINING THE TENT

Protecting the Tent

Ultraviolet (UV) damage is the largest hazard for tents. Fabrics should not be exposed to sunlight for extended periods of time; this will eventually result in colour fading and fabric failure. The uncoated fabrics of the tent canopy are most susceptible to damage from UV and should be covered by the more durable fly. If extended exposure is unavoidable, cover the tent with a tarp or a sheet of nylon.

Lighting the Tent

Using a candle lantern in a tent carries definite risks. Never leave a candle lantern burning unattended; always watch for fire hazards from overheating fabrics or spilling wax. Spilling wax can be dangerous, particularly to eyes and other sensitive areas. Use candle lanterns wisely and with extreme caution. Cooking in a tent is strongly discouraged because of fire hazards and carbon monoxide inhalation risks. Unlike campfire smoke and other fumes, carbon monoxide can render someone unconscious without warning.

Not Eating in the Tent

Mop up spills promptly with water. Many foods, particularly acidic ones like fruit or juices, can weaken synthetic fabrics over time. It is best to eat and store food away from a tent to avoid attracting animals.

Cleaning the Tent

Clean the tent by hand while it is set up, using a sponge, a mild non-detergent soap, and warm water. Rinse thoroughly. Do not dry clean, machine wash, or machine dry. Stubborn stains like tar can be left in place and dusted with talcum powder to prevent transfer to other areas of the tent in storage. After cleaning, a spray-on water repellent designed for synthetic fabrics may be applied to the flysheet if surface water repellent is weakened. This is apparent when water droplets no longer bead on the fabric. If the poles are exposed to salt or salt water, rinse them in fresh water and allow them to dry before storing (while aluminum does not rust, it can become brittle through unseen corrosion over time).

CONFIRMATION OF TEACHING POINT 3

The cadets' participation in erecting, tearing down and packing an arctic tent or civilian-pattern tent will serve as the confirmation of this TP.

END OF LESSON CONFIRMATION

The cadets participation in erecting, tearing down and packing a modular tent and either an arctic tent or civilian-pattern tent will serve as the confirmation of this lesson.

CONCLUSION

HOMEWORK / READING / PRACTICE

Nil.

METHOD OF EVALUATION

Nil.

CLOSING STATEMENT

It is important for the cadets to be able to setup / tear down a modular tent because they are often used during aircrew survival exercises. A cadet's understanding of this lesson will allow them to better assist in the set-up of a aircrew survival exercise.

INSTRUCTOR NOTES / REMARKS

If the squadron does not have access to modular tents, have the cadets erect, tear down and pack the arctic tent and the civilian-pattern tent.

Cadets who are qualified Survival Instructor may assist with this instruction.

REFERENCES

A3-059 C-87-110-000/MS-000 Canadian Forces. (1983). *Operational support and maintenance manual: Tent, main*. Ottawa, ON: Department of National Defence.

A3-060 B-GG-302-002/FP-001 Canadian Forces. (1974). *Arctic and Sub-Arctic operations: Part 1*. Ottawa, ON: Department of National Defence.

THIS PAGE INTENTIONALLY LEFT BLANK

FOLDING A SINGLE TENT SECTION

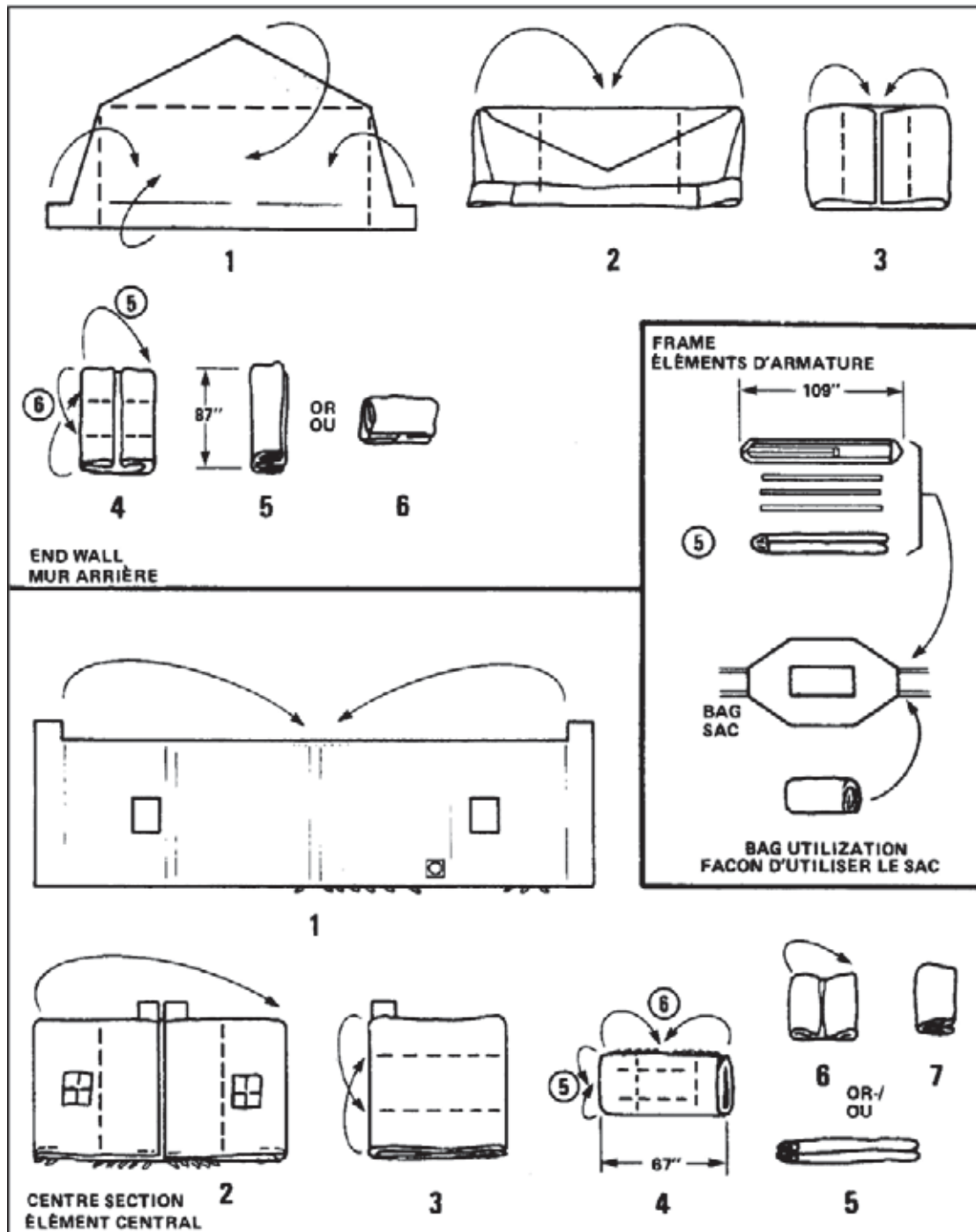

Figure A-1 Folding a Single Tent Section

Note. From C-87-110-000/MS-000 Operational Support and Maintenance Manual for Tent, Main(p. 2-17), by DND Canada, 1983, Ottawa ON: Department of National Defence. Copyright 1983 by DND Canada.

FOLDING LACED TENT SECTION

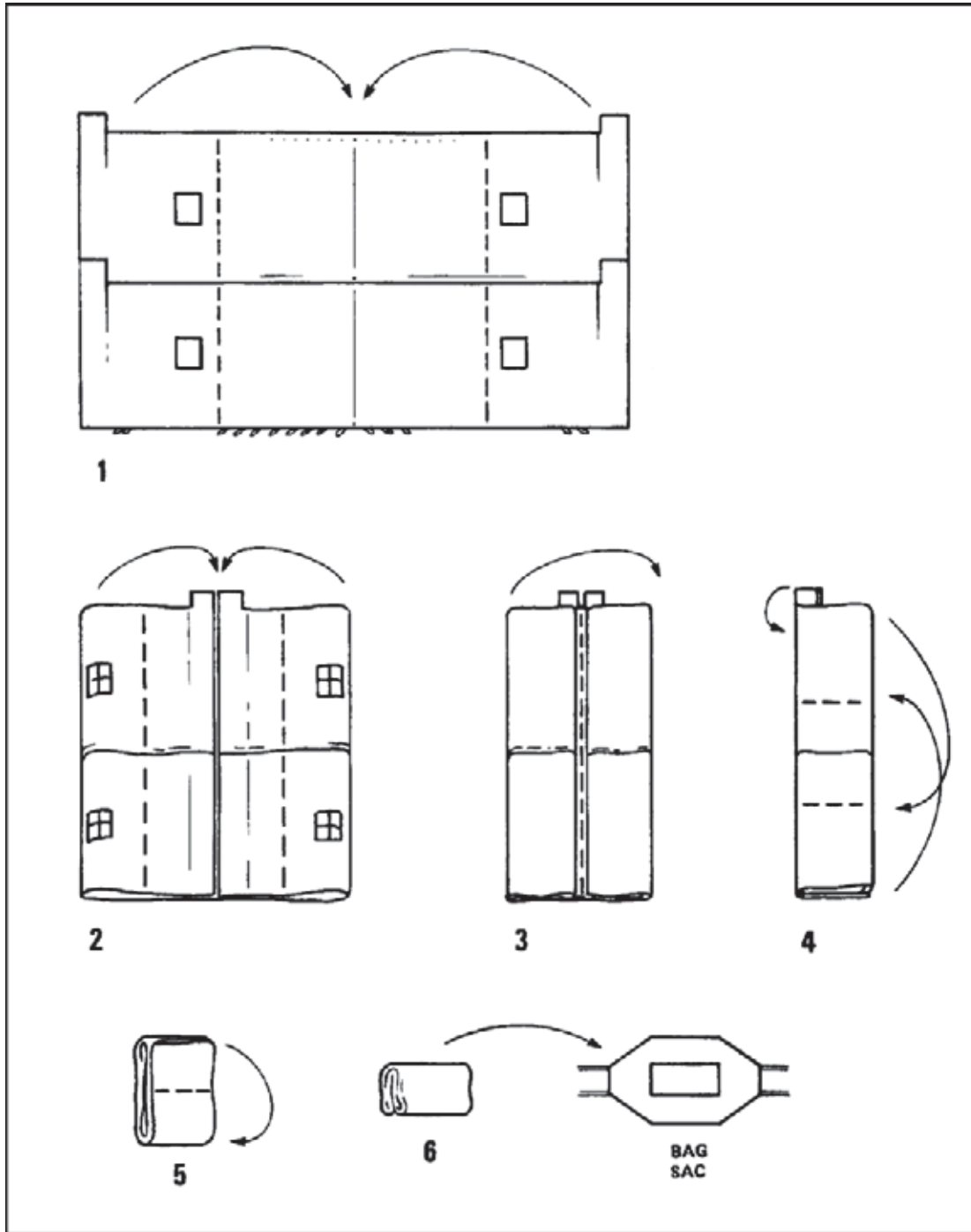

Figure A-2 Folding Laced Tent Sections

Note. From C-87-110-000/MS-000 *Operational Support and Maintenance Manual for Tent, Main*(p. 2-18), by DND Canada, 1983, Ottawa ON: Department of National Defence. Copyright 1983 by DND Canada.