

CHAPTER 8

PO 308 – DIRECT A FLIGHT PRIOR TO A PARADE



COMMON TRAINING
PROFICIENCY LEVEL THREE
INSTRUCTIONAL GUIDE



SECTION 1

EO M308.01 – PREPARE A SQUAD FOR PARADE

Total Time:

90 min

PREPARATION

PRE-LESSON INSTRUCTIONS

Resources needed for the delivery of this lesson are listed in the lesson specification located in A-CR-CCP-803/PG-001, Chapter 4. Specific uses for said resources are identified throughout the instructional guide within the TP for which they are required.

Review the lesson content and become familiar with the material prior to delivering the lesson.

Photocopy the drill sequence handout at Annex A and the aide-mémoire card at Annex B as required.

PRE-LESSON ASSIGNMENT

N/A.

APPROACH

An interactive lecture was chosen for TP 1 to introduce drill theory to the cadet.

Demonstration and performance was chosen for TP 2 as it allows the instructor to explain and demonstrate preparing a flight for a parade while providing an opportunity for the cadets to practice the skill under supervision.

INTRODUCTION

REVIEW

N/A.

OBJECTIVES

By the end of this lesson the cadet shall be expected to prepare a flight for parade.

IMPORTANCE

It is important for cadets to be able to prepare a flight for parade as they will be in placed in a team leader role and will need to know the formations and locations of all members on the parade square.

Teaching Point 1

Explain Drill Theory

Time: 20 min

Method: Interactive Lecture

SQUAD FORMATIONS



The term squad is a generic name for a group of cadets. This term can be interchanged with flight, platoon, division or any other applicable elemental or regimental term.



The squad formation should be implemented when there is a parade strength of less than 32 cadets.

Squad formations are essential to maintain control and ensure uniformity. The instructor shall determine the formation to be used, based on the number of cadets present, to include:

Single Rank. A single rank shall be formed when there are five or fewer cadets.

Two Ranks. Two ranks shall be formed when there are six to nine cadets.

Three Ranks. Three ranks shall be formed when there are 10 or more cadets.

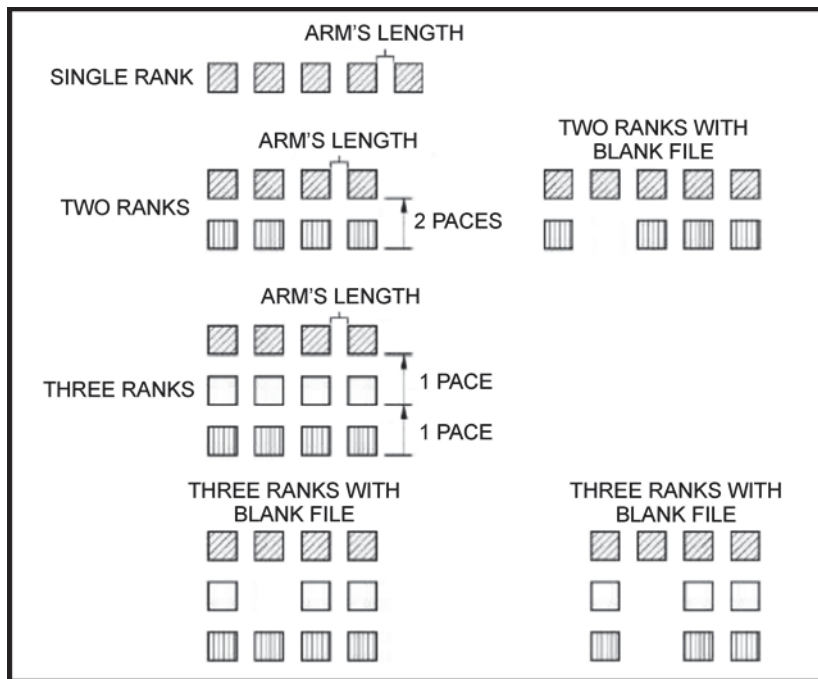

A-PD-201-000/PT-000 (p. 2-2)

Figure 8-1-1 Squad Formations



When there are not enough cadets to form complete files, a file shall be left blank (as illustrated in Figure 8-1-1). The file blank shall be the second file from the left.

In two ranks, this blank file is without a rear rank cadet, and in three ranks, this blank file is without a centre and/or rear rank cadet.

The symbol for the Parade Commander (Pde Comd) is:



The symbol for the Parade Deputy Commander (Dcomd) is:



The symbol for the Squadron Warrant Officer (SWO) is:



The symbol for Flight Commander (Flt Comd) is:



The symbol for the Flight Sergeant (Flt Sgt) is:



The symbol Flight Marker (Marker) is:



Director Cadets 3, 2008, Ottawa, ON: Department of National Defence

Figure 8-1-2 Parade Appointment Symbols

SQUADRON FORMATIONS

A squadron consists of two or more flights. The aim of squadron drill is to manoeuvre the flight as one under the command of a parade commander and assistance of a parade deputy commander. Other senior non-commissioned officers (NCOs) not directly involved with the flights, shall be supernumeraries and form supernumerary ranks as directed by the parade commander. There shall be seven paces between flights for all formations.



When space is limited, intervals and distances between flights may be decreased.

There are three squadron formations used by cadets, to include:

Line. A squadron is formed in line when flights are formed up side-by-side, seven paces apart and aligned facing the front, with parade appointments located in the front and rear of the formation (as illustrated in Figure 8-1-3).



To be formed in threes and in line is the common formation when a squad forms up.

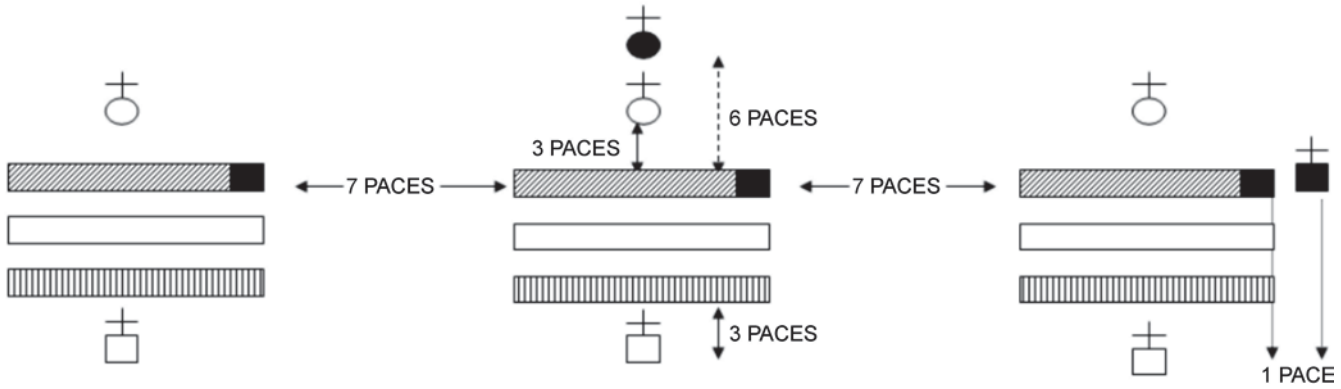

Director Cadets 3, 2008, Ottawa, ON: Department of National Defence

Figure 8-1-3 Squadron in Line

Column of Threes. A squadron is formed in column of threes when flights are turned to the right or left of the front, with parade appointments located in their positions in the front and rear of the formation and turned to the right or left with the flight (as illustrated in Figure 8-1-4).

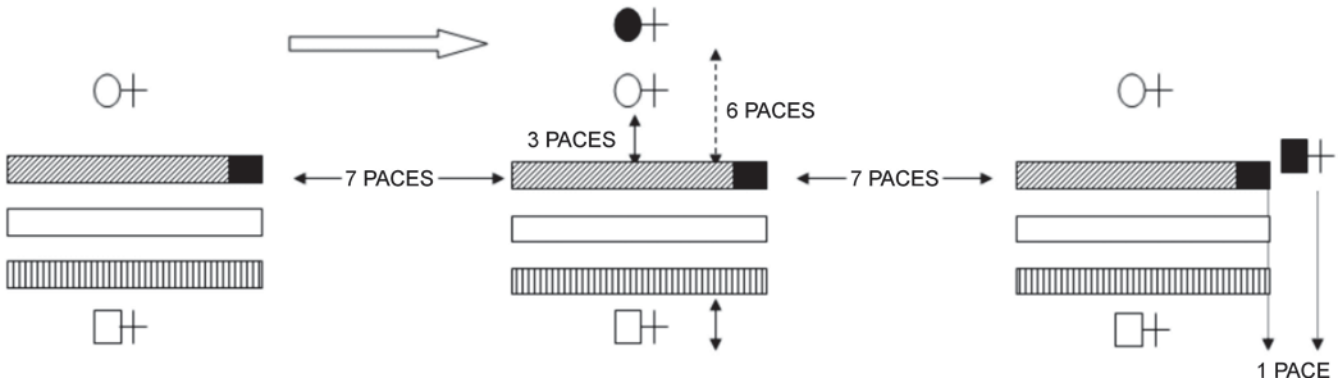

Director Cadets 3, 2008, Ottawa, ON: Department of National Defence

Figure 8-1-4 Squadron in Column of Threes

Column of Route. A squadron is formed in column of route when flights are turned to the right or left, with parade appointments positioned to lead or follow the formation (as illustrated in Figure 8-1-5).

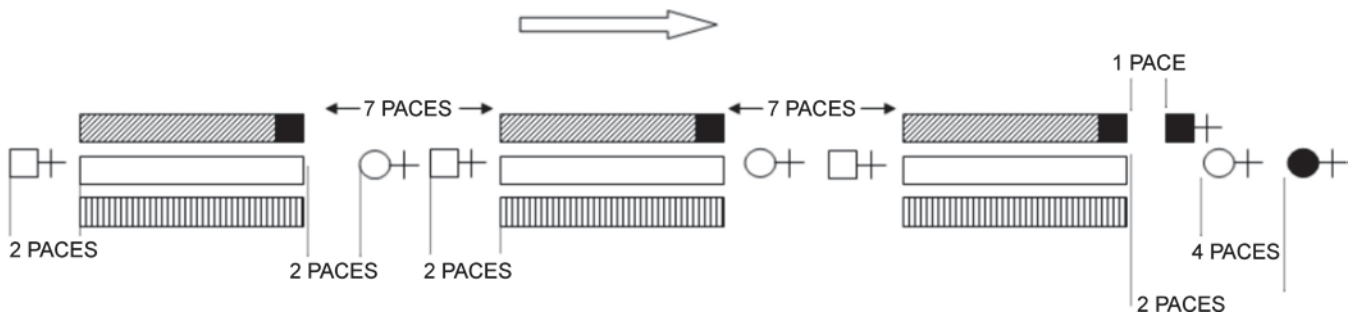

Director Cadets 3, 2008, Ottawa, ON: Department of National Defence

Figure 8-1-5 Squadron in Column of Route

LOCATION OF PARADE APPOINTMENTS

The unique nature of the cadet squadron allows for the adjustment of parade positions to be filled by cadet WOs and cadet senior NCOs. The following parade positions are normally filled by cadets when conducting a formal parade:

Parade Commander (Pde Comd). With a squadron in line or in column of threes, the Pde Comd is centred three paces in front of the line of flight commanders, facing the same direction as the flights except when addressing the squadron. With a squadron in column of route, the Pde Comd is centred four paces in front of the leading flight.

Parade Deputy Commander (DComd). The DComd is an appointment that is seldom assigned in a cadet squadron. If applicable, the DComd is centred three paces in front of the second single file from the right flank of the squadron and in line with the Flt Comd.

Squadron Warrant Officer (SWO). With a squadron in line or in column of threes, the SWO is located one pace to the right of the No. 1 Flight marker, in line with the front rank. With a squadron in column of route, the SWO is located one pace in front of the directing flank of the leading flight.

Flight Commander (Flt Comd). With a squadron in line or in column of threes, the Flt Comd is centred three paces in front of the flight. With a squadron in column of route, the Flt Comd is centred two paces in front of their flight.

Flight Sergeant (Flt Sgt). With a squadron in line or in column of threes, the Flt Sgt is centred three paces in rear of the flight. With a squadron in column of route, the Flt Sgt is centred two paces in the rear of their flight.



Prior to handing over to the Flt Comd, the Flt Sgt will be centred three paces in front of the flight. After handing over to the Flt Comd, the Flt Sgt assumes their position as stated above.

Flight Marker (Marker). The marker is the individual placed in the first rank of the first file to indicate the position which a body of cadets will occupy when covering and falling in. In all squad and squadron formations, the marker remains in the same location.

CONFIRMATION OF TEACHING POINT 1

QUESTIONS

- Q1. What are the three squad formations?
- Q2. What are the three squadron formations?
- Q3. Where is the Flt Comd located when the formation is in line?

ANTICIPATED ANSWERS

A1. The three squad formations are:

- single rank,
- two ranks, and
- three ranks.

A2. The three squadron formations are:

- line,

- column of threes, and
- column of route.

A3. The Flt Comd is located three paces in front and centre of the flight.

Teaching Point 2

Explain, Demonstrate and Have the Cadet Assume the Role of a Team Leader in Preparing a Squad for Parade

Time: 60 min

Method: Demonstration and Performance

When preparing a squad for parade, the team leader, acting as the Flt WO, is responsible to ensure the squad is ready for parade by:

1. having the squad on the parade square by falling in a squad;
2. knowing who is present or absent by calling the roll;
3. ensuring uniformity of the squad by sizing in single rank and reforming threes (twos);
4. ensuring the squad is properly spaced by dressing a squad;
5. ensuring all cadets are well turned out by inspecting a squad; and
6. continuing with the parade by handing over the squad.



The purpose of this TP is to aid the cadets' comprehension of the process they have executed during Proficiency Level One and Two when preparing for parade during a training sessions.



If the time allotted is not sufficient for all cadets to assume the role of a team leader in preparing a squad for parade, additional time during nightly opening and closing parades shall be used to provide all cadets the opportunity for performance.

ACTIVITY

OBJECTIVE

The objective of this activity is to confirm the ability of a Proficiency Level Three cadet, as a team leader, to prepare a squad for parade.

RESOURCES

N/A.

ACTIVITY LAYOUT

N/A.

ACTIVITY INSTRUCTIONS

Distribute a copy of the drill sequence handout at Annex A and an aide-mémoire card at Annex B to each cadet.

This activity will be conducted IAW Annex A.



For this activity, it is recommended that instruction take the following format:

1. Explain and demonstrate the complete skill while cadets observe.
2. Explain and demonstrate each step required to complete the skill.
3. Select a cadet to assume the role of team leader and practice the complete skill.

Note: Assistant instructors may be employed for demonstration purposes.

SAFETY

N/A.

CONFIRMATION OF TEACHING POINT 2

The cadets' participation in the activity will serve as the confirmation of this TP.

END OF LESSON CONFIRMATION

The cadets' participation in preparing a squad for parade will serve as the confirmation of this lesson.

CONCLUSION

HOMEWORK/READING/PRACTICE

N/A.

METHOD OF EVALUATION

This EO is assessed IAW A-CR-CCP-803/PG-001, Chapter 3, Annex B, Appendix 2 (308 PC).

CLOSING STATEMENT

When preparing a squad for parade with confidence and determination, it will affect how cadets respond to the orders given. Delivering words of command can allow a flight to move as a team in an organized and efficient manner as all members learn to work together.

INSTRUCTOR NOTES/REMARKS

Cadets shall perform these skills and be given feedback during weekly opening and closing parades, and ceremonial parades.

Assistant instructors may be required for this lesson.

REFERENCES

A0-002 A-PD-201-000/PT-000 Director History and Heritage 3-2. (2005). *The Canadian Forces Manual of Drill and Ceremonial*. Ottawa, ON: The Department of National Defence.

THIS PAGE INTENTIONALLY LEFT BLANK



COMMON TRAINING
PROFICIENCY LEVEL THREE
INSTRUCTIONAL GUIDE



SECTION 2

EO M308.02 – DELIVER WORDS OF COMMAND

Total Time:

30 min

PREPARATION

PRE-LESSON INSTRUCTIONS

Resources needed for the delivery of this lesson are listed in the lesson specification located in A-CR-CCP-803/PG-001, Chapter 4. Specific uses for said resources are identified throughout the instructional guide within the TP for which they are required.

Review the lesson content and become familiar with the material prior to delivering the lesson.

Photocopy, cut out, fold and laminate the aide-mémoire cards with the words of command located at Annex C for each cadet.

PRE-LESSON ASSIGNMENT

N/A.

APPROACH

An interactive lecture was chosen for TP 1 to orient the cadets to the parts of a command and to generate interest.

Demonstration was chosen for TP 2 as it allows the instructor to demonstrate the voice techniques the cadets are expected to acquire.

INTRODUCTION

REVIEW

N/A.

OBJECTIVES

By the end of this lesson the cadet shall be expected to deliver words of command.

IMPORTANCE

It is important for cadets to know how to deliver words of command. Words of command that are delivered in a clear and concise manner, with confidence and determination, will affect how cadets respond to orders. Words of command are required to move a flight in an organized and efficient manner.

Teaching Point 1**Explain the Parts of a Command**

Time: 10 min

Method: Interactive Lecture

CAUTIONARY COMMAND

A cautionary command shall be given at the beginning of every command to warn the squad that a movement will be performed. It includes additional instructions to the command such as “advance” or “retire”.



The direction of the movements are indicated based on the initial front rank.

The additional instructions are based on the direction a squad falls in (as illustrated in Figure 8-2-1). In general:

- **Advance.** Indicates a turn or movement in the direction of the front rank (is used whenever turning into line).
- **Retire.** Indicates a turn or movement in the direction of the rear rank (is used whenever turning into line).
- **Move to the Right/Left.** Indicates a turn or movement in the direction of the indicated flank (eg, the right/left markers).

EXECUTIVE COMMAND

An executive command is to signal that the movement is to be carried out.

When written, a dash shall separate the cautionary command from the executive command.

The following are examples of words of command. In these examples, the word “TURN” indicates the executive command.

- “SQUAD RETIRE, RIGHT—TURN,”
- “SQUAD ADVANCE, LEFT—TURN,” and
- “SQUAD MOVE TO THE RIGHT IN COLUMN OF ROUTE, RIGHT—TURN.”

On the march, the cautionary command should be drawn out over at least two paces of quick time and the interval between the cautionary and executive commands should be two paces.



The order, “As You Were”, should only be given when another word of command cannot be given to have a squad adopt a previous position or to cancel an incorrect order before it has been completed.

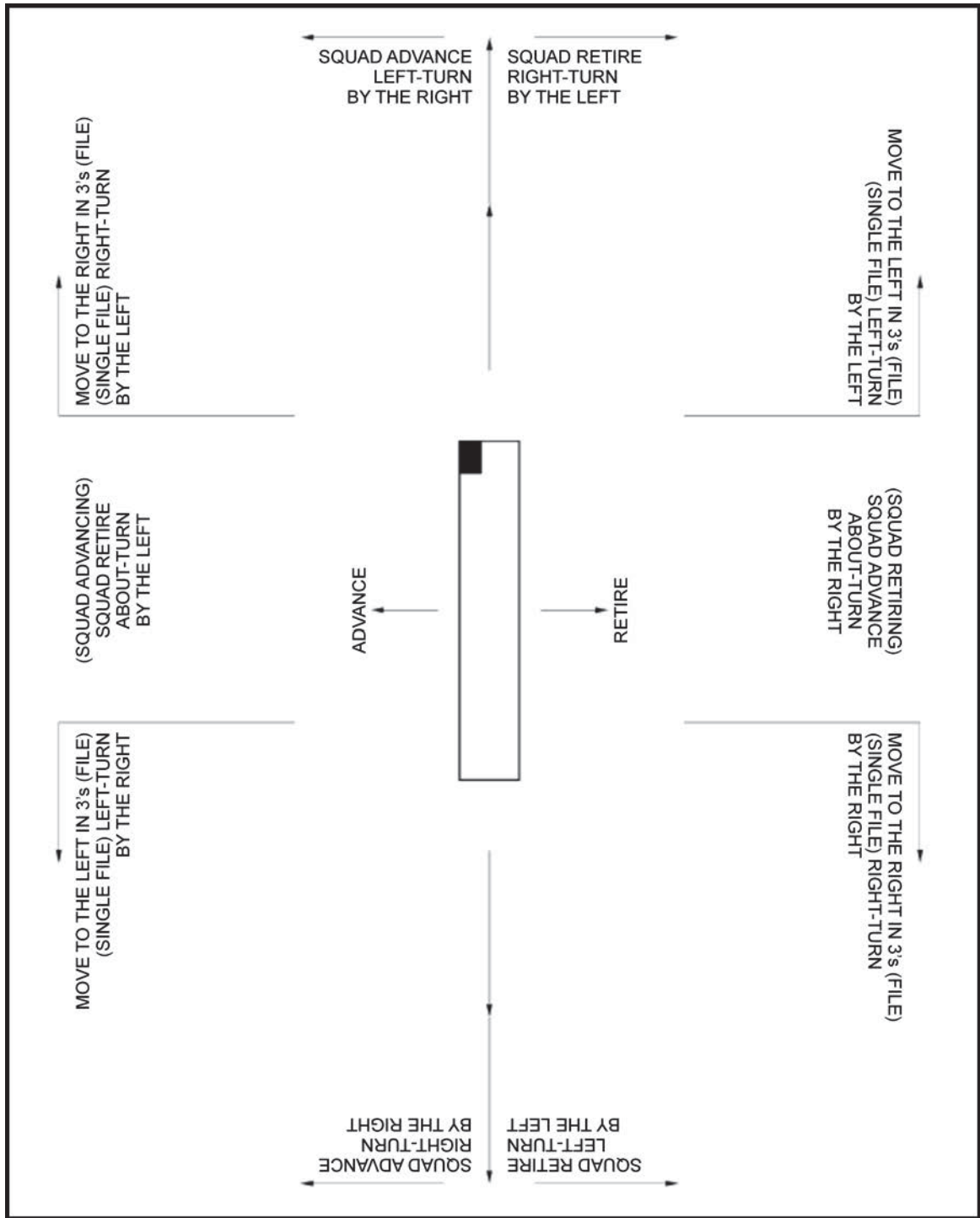

A-PD-201-000/PT-000 (p. 3-4)

Figure 8-2-1 Advance/Retire and Directing Flanks

CONFIRMATION OF TEACHING POINT 1

QUESTIONS

Q1. Why are cautionary commands given?

Q2. What is the purpose of the executive command?

Q3. When commands are written, what is the purpose of the dash?

ANTICIPATED ANSWERS

A1. To warn the squad that a movement will be performed.

A2. To signal that the movement is to be carried out.

A3. To separate the cautionary from the executive command.

Teaching Point 2

Demonstrate and Explain the Requirements for a Well-Delivered Command

Time: 15 min

Method: Demonstration



As each point is discussed, give an example of a command being delivered correctly and incorrectly, using the specified technique.

VOICE

The voice used to deliver commands has a strong effect on how others will respond. The following points should be considered:

Volume. The volume used to deliver a command is very important in drill. Often, commands must be presented to a group over a band or over other cadets giving commands to another group. The volume should be adjusted based on the number of individuals, the distance the command must carry and whether there is a band or not.

Projection. The projection of the voice is its ability to reach a desired distance. Erect posture, proper breathing, a relaxed throat and an open mouth will help a voice project.

Distinctness. How clearly and distinctly a command is pronounced will affect how others respond. If a command is not clear and distinct some cadets may not understand the command and perform the wrong movement. Clear enunciation and pronunciation of commands is key in distinctness.

Inflection. Inflection is the change in pitch of the voice. The cautionary command is usually started with a pitch near the level of the normal speaking voice and rising toward the end. The executive command should not have any change in inflection but should be delivered with a higher pitch than the cautionary command.

Snap. The snap of a command is the quality that demands an immediate response. It expresses the confidence and decisiveness of the commander.

ACCURACY

Commands must be given with accuracy at all times. Proper use of cautionary commands will alert the cadets to what is coming. The executive command will signal the cadets that the movement is to be carried out. When delivering executive commands on the march, it is important that it be delivered on the correct foot.

CONFIDENCE

All words of command must be given with confidence. This portrays that it is an order that must be promptly and smartly obeyed. A command delivered with confidence will help build a sense of security in the commander from the members of the squad.

CORRECT POSTURE

Poor posture restricts the ability to breathe deeply as it restricts the movement of the diaphragm. Maintaining good posture will allow a cadet to breathe deeply allowing the command to come deep from the diaphragm instead of from the throat causing less strain on the throat and allowing the command to be given with more volume.

BREATHING CONTROL

Breathe deeply and relax the muscles in the neck and vocal cords in order to give the voice more control and a higher volume. This will allow the voice to come from deep in the diaphragm instead of higher in the throat.

CONFIRMATION OF TEACHING POINT 2

QUESTIONS

- Q1. If a command is not pronounced clearly and distinctly, what affect may it have on the squad being commanded?
- Q2. Why should commands be delivered with confidence?
- Q3. How does poor posture affect delivering commands?

ANTICIPATED ANSWERS

- A1. Cadets may not understand the command and perform the wrong movement.
- A2. It portrays that it is an order that must be promptly and smartly obeyed.
- A3. It restricts the ability to breathe deeply, restricting the movement of the diaphragm, which will cause commands to come from the throat.

END OF LESSON CONFIRMATION

QUESTIONS

- Q1. What order is given to cancel an incorrect order before it has been completed?
- Q2. What are the five points of voice to be considered for a well-delivered command?
- Q3. What gives the voice more control and a higher volume?

ANTICIPATED ANSWERS

- A1. The order, "As You Were".
- A2. Volume, projection, distinction, inflection and snap.
- A3. Breathing deeply and relaxing the muscles in the neck and vocal cords.

CONCLUSION

HOMEWORK/READING/PRACTICE

N/A.

METHOD OF EVALUATION

N/A.

CLOSING STATEMENT

When words of command are delivered in a clear and concise manner and with confidence and determination, it will affect how cadets respond to the order. Delivering words of command can allow a platoon to move as a team in an organized and efficient manner as all members learn to work together.

INSTRUCTOR NOTES/REMARKS

Cadets shall be provided the opportunity to deliver words of command and be given feedback during weekly opening and closing parades, and ceremonial parades.

Additional time for this EO is available in EO C308.02 (Deliver Words of Command, Section 4).

REFERENCES

- A0-002 A-PD-201-000/PT-000 Director History and Heritage 3-2. (2005). *The Canadian Forces Manual of Drill and Ceremonial*. Ottawa, ON: Department of National Defence.
- C0-022 (ISBN 0-02-864207-4) Cole, K. (2002). *The Complete Idiot's Guide to Clear Communication*. Indianapolis, IN: Alpha Books.
- C0-241 Optimal Breathing. (2007). *Posture and Breathing*. Retrieved February 12, 2008, from <http://breathing.com/articles/posture.htm>
- C0-269 AFMAN 36-2203 Department of the Air Force. (1996). *Drill and Ceremonies*. Lackland, AFB, TX: Secretary of the Air Force.



COMMON TRAINING
PROFICIENCY LEVEL THREE
INSTRUCTIONAL GUIDE



SECTION 3
EO C308.01 – EXECUTE FLAG DRILL

Total Time:

180 min

PREPARATION

PRE-LESSON INSTRUCTIONS

Resources needed for the delivery of this lesson are listed in the lesson specification located in A-CR-CCP-803/PG-001, Chapter 4. Specific uses for said resources are identified throughout the instructional guide within the TP for which they are required.

Review the lesson content and become familiar with the material prior to delivering the lesson.

For further direction and information on cadet flags and banners, refer to CATO 12-05, *Cadet Flags and Banners*, Paragraphs 1 to 9.

PRE-LESSON ASSIGNMENT

N/A.

APPROACH

An interactive lecture was chosen for TP 1 to present basic background material on flags and flag parties.

Demonstration and performance was chosen for TPs 2 to 6 as it allows the instructor to demonstrate and explain the skills the cadets are expected to acquire while providing an opportunity for the cadets to practice flag drill under supervision.

INTRODUCTION

REVIEW

N/A.

OBJECTIVES

By the end of this lesson the cadet, as a member of a flag party, shall have executed flag drill.

IMPORTANCE

It is important for cadets to execute flag drill so they are able to take part in ceremonies and parades as members of the flag party at the squadron, cadet summer training centre (CSTC) and other community events as required.

Colours and flags have many meanings and are symbols of such things as achievements, nationality and identity. It is considered an honour to be a member of the flag party.

Teaching Point 1

Explain Details of Flags, the Pike, the Colour Carrying Belt and the Composition of a Flag Party

Time: 10 min

Method: Interactive Lecture

FLAGS

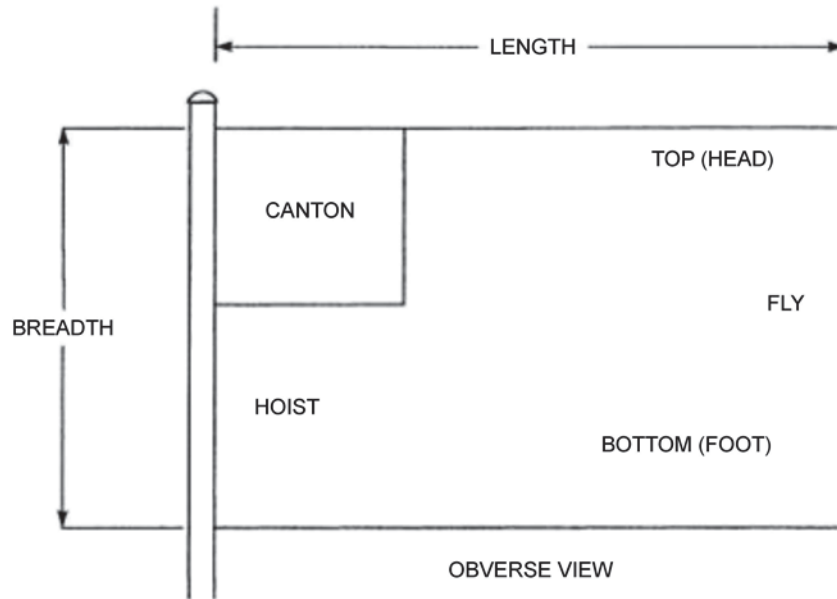

A-AD-200-000/AG-000, *The Honours, Flags and Heritage Structure of the Canadian Forces* (p. 4-1-8)

Figure 8-3-1 Details of a Flag

Flags. As a generic term (including colours), flags are pieces of bunting or other material, attachable to a pike, staff or halyard, and used as a means of identification or for signalling.

Canton. The upper half of the hoist. It is also called the First Quarter and sometimes the Upper Hoist. The canton is considered the place of honour on a flag.

Hoist. The half of the flag nearest to the halyard.

Halyard. The rope that raises or lowers a flag.

Fly. The half of the flag furthest from the halyard.

Staff (Flagstaff). A pole on which a flag is mounted for display.



Colours are consecrated ceremonial flags carried to mark the identity of Canadian Forces (CF) formations and units. They belong to a separate class and are not paraded with other flags. Cadet flags are not consecrated (made sacred and devoted to service by the Chaplain General as symbols of honour and duty), therefore shall not be referred to as colours.

Commanding Officers of cadet squadrons and CSTCs shall ensure that flags and banners are not referred to as colours, adorned with honours or consecrated and not issued at public expense.

Flags are used to identify individuals and groups. Many flags which originated as the insignia of individuals gradually came to represent the state or agencies within the state.

Authorized Flags and Banners

The following is a list of flags and banners that may be carried on parade by cadet squadrons:

1. the Royal Canadian Sea Cadets Ensign,
2. the Royal Canadian Army Cadets Flag,
3. the Royal Canadian Air Cadets Ensign, and
4. the Royal Canadian Air Cadets Squadron Banner.

The following is a list of flags and banners that should only be carried on ceremonial parades to indicate a cadet formation:

1. the Royal Canadian Army Cadets Banner,
2. the Royal Canadian Army Cadets Trumpet Banner,
3. the Royal Canadian Army Cadets Pipe Banner,
4. the Royal Canadian Air Cadets Banner, and
5. the Royal Canadian Air Cadets Pipe Banner.

THE PIKE

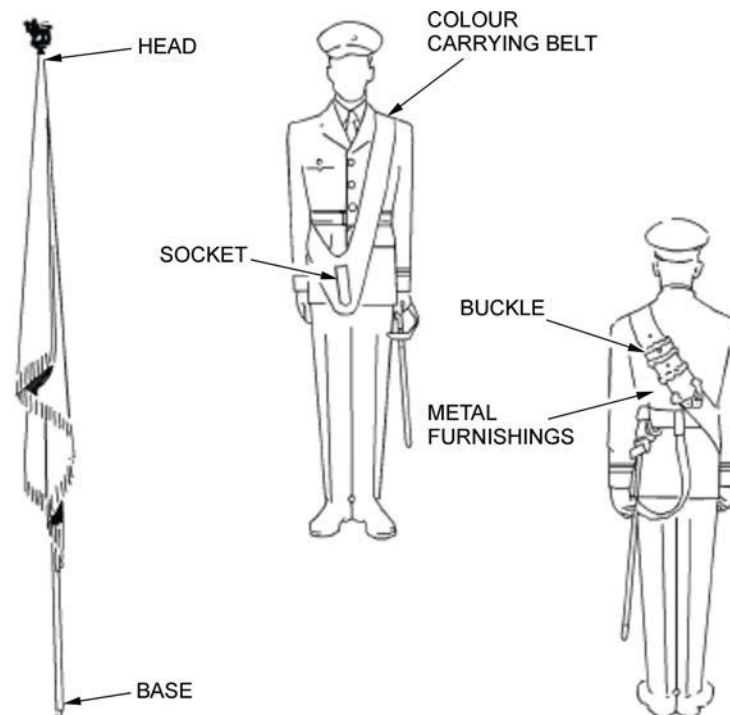

A-PD-201-000/PT-000 (p. 8-2-3)

Figure 8-3-2 Details of the Pike and Colour Carrying Belt

Pike. A pole on which colours or other flags are mounted for carrying or displaying.

Pike Head. The decorative ornament (finial) on the top of a pike, staff or pole.

COLOUR CARRYING BELT

The colour carrying belt is worn over the left shoulder by members of the flag party carrying flags. The socket is the “pocket” where the pike base is placed while the flag is in the carry position.

COMPOSITION OF A FLAG PARTY

LEGEND

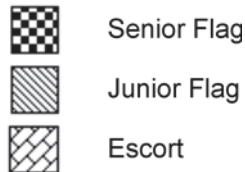

*Director Cadets 3, 2008, Ottawa,
ON: Department of National Defence*



Figure 8-3-4 Flag Party for One Flag

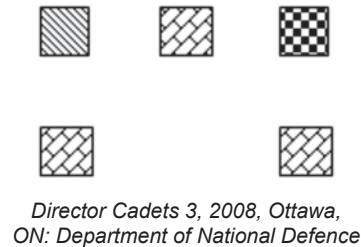

Figure 8-3-5 Flag Party for Two Flags

Figure 8-3-3 Flag Party Legend

The composition of a flag party carrying one flag (as illustrated in Figure 8-3-3) consists of the flag party commander (cadet carrying the flag) and two escorts (cadets on either side of the flag).

The composition of a flag party carrying two flags (as illustrated in Figure 8-3-4) consists of one senior escort (cadet between the flags), the flag party commander and one flag bearer (cadets carrying the flags) and two senior NCOs (cadets directly behind the flags).

The flag party commander and/or flag bearer is appointed to carry, handle and protect the flags.

The senior escort and/or escort are appointed to safeguard the flags. They remain with the flags and may or may not carry drill-purpose rifles.



When a cadet flag party carries the national flag and either the Air Cadet Ensign or the Squadron Banner, the national flag occupies the position of honour on the right (on the left from the spectators view) and is normally carried by a senior cadet.

Normally, the national flag does not have an escort. It may be given an escort with a drill-purpose rifle if the cadets on parade are carrying drill-purpose rifles.

CONFIRMATION OF TEACHING POINT 1

QUESTIONS

- Q1. What is a pike?
- Q2. Over which shoulder is the colour carrying belt worn?
- Q3. How many members are in a flag party with only one flag?

ANTICIPATED ANSWERS

- A1. A pike is a pole on which colours or other flags are mounted for carrying or displaying.
- A2. The colour carrying belt is worn over the left shoulder.

A3. There are three members in a flag party with only one flag: the flag party commander and two escorts.

Teaching Point 2

Demonstrate, Explain and Have the Cadets Practice Adopting the Order, Stand at Ease From the Order, Stand Easy From the Stand at Ease, Stand at Ease From the Stand Easy and Order From the Stand at Ease With a Flag

Time: 15 min

Method: Demonstration and Performance



Develop and use a vocabulary of short, concise words to impress on the cadets that the movements must be performed smartly. For example, the words “crack”, “drive”, “seize” and “grasp” suggest the degree of smartness required. Profanity or personal sarcasm shall never be used.

Proper drill movements shall be combined with a professional demeanour throughout the period of instruction.

Check for faults and correct them immediately as they occur.



Each TP is to be conducted as follows:

1. Have the cadets fall in, in an effective squad formation (eg, hollow square, semi-circle or single rank).
2. Demonstrate and explain each movement, as time allows.
3. Give the cadets time to practice each movement on their own.
4. After all movements have been demonstrated and practiced, deliver commands and have all the cadets perform them as a squad.



Capitalization indicates the words of command for each movement.

Cadence is to be maintained while completing these movements.

THE ORDER (ATTENTION)



A-PD-201-000/PT-000 (p. 8-3-2)

Figure 8-3-6 The Order (Attention)

To assume the position of the order (attention), the cadets shall:

1. Stand with heels together and in line, with the feet turned out to form an angle of 30 degrees.
2. Maintain balance and distribute weight evenly on both feet.
3. Keep the shoulders squared and to the front.
4. Hold the head erect with the neck touching the back of the collar, eyes steady, looking directly to the front.
5. Hold the pike vertical in the right hand, along the right side.
6. Keep the base of the pike on the ground at the right foot in line with the small toe.
7. Hold the pike and flag with an all-round grasp with the right hand, with the back of the hand pointed outwards at the point of the pike where the lowest corner of the flag hangs.
8. Ensure the flag hangs naturally down the pike and is not pulled taut.
9. Keep the right elbow at the side.
10. Hold the left arm at the position of attention.

STAND AT EASE FROM THE ORDER

A-PD-201-000/PT-000 (p. 8-3-2)

Figure 8-3-7 Stand at Ease

On the command, STAND AT—EASE, the cadets shall:

1. bend the left knee and place the left foot smartly on the ground 25 cm (approximately 10 inches) to the left;
2. maintain the left arm in the position of attention; and
3. maintain the pike and flag in the position of the order.



Timing for this movement is one.

STAND EASY FROM STAND AT EASE

On the command, STAND—EASY, the cadets shall:

1. maintain the feet at the position of stand at ease;
2. keep the left arm at the side; and
3. relax the body.



Timing for this movement is one.

STAND AT EASE FROM STAND EASY

On the command, SQUAD, the cadets shall resume the position of stand at ease.



Timing for this movement is one.

ORDER FROM STAND AT EASE

On the command, ATTEN—TION, the cadets shall:

1. bend the left knee and bring the left foot to the position of attention, keeping the left arm at the side; and
2. maintain the pike and flag in the position of the order.



Timing for this movement is one.

CONFIRMATION OF TEACHING POINT 2

The cadets' practicing of the order, stand at ease and stand easy, with a flag, will serve as the confirmation of this TP.

Teaching Point 3**Demonstrate, Explain and Have the Cadets Practice Adopting the Carry From the Order, Order From the Carry, Let Fly From the Carry and Catch the Flag From the Let Fly**

Time: 25 min

Method: Demonstration and Performance

CARRY FROM THE ORDER*A-PD-201-000/PT-000 (p. 8-3-4)*

Figure 8-3-8 Carry From the Order

On the command, CARRY—FLAGS, the cadets shall:

1. on the first movement:
 - (a) with the right hand, carry the flag to a vertical position in front of the centre of the body, keeping the right forearm along the side of the pike, and keeping the base of the pike just over the socket of the carrying belt; and
 - (b) simultaneously, bring the left hand to the socket and guide in the base of the pike; and
2. on the second movement:
 - (a) cut the left hand to the side in the position of attention; and
 - (b) simultaneously, bring the right forearm parallel to the ground so that upon completion of the movement, the right hand is opposite the mouth with the back of the right hand facing out, the wrist straight and the forearm parallel to the ground.

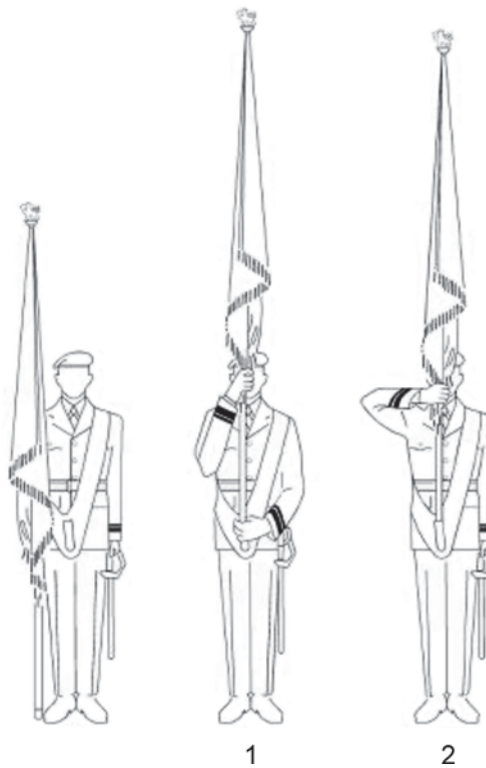

Timing for this movement is one-two-three, one.

ORDER FROM THE CARRY

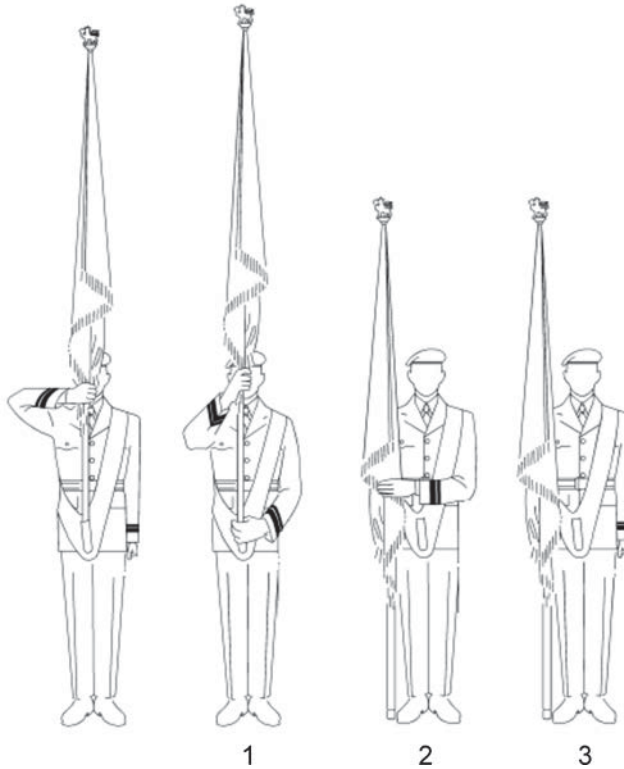

A-PD-201-000/PT-000 (p. 8-3-6)

Figure 8-3-9 Order From the Carry

On the command, ORDER—FLAGS, the cadets shall:

1. on the first movement:
 - (a) bring the right forearm from a horizontal to a vertical position along the pike and with the right hand, raise the pike clear of the socket of the carrying belt; and
 - (b) simultaneously, bring the left hand to the socket to steady the pike and the carrying belt; and
2. on the second movement:
 - (a) carry the flag with the right hand to the position of the order; and
 - (b) simultaneously, move the left hand across the body to steady the pike with the forearm parallel to the ground, the back of the hand facing out, and the fingers of the left hand together, extended and pointing to the right; and
3. on the third movement, cut the left hand to the side in the position of attention.



Timing for this movement is one-two-three, one-two-three, one.

LET FLY FROM THE CARRY

Let fly is used either as a salute to dignitaries or to allow for the identification of the flag.

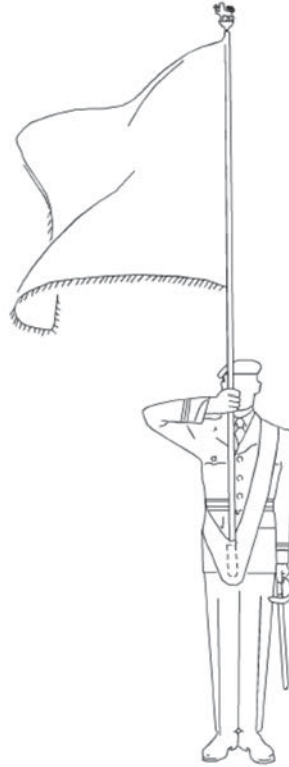

A-PD-201-000/PT-000 (p. 8-3-17)

Figure 8-3-10 Let Fly From the Carry

On the command LET FLY THE—FLAG(S), the cadets shall:

1. maintain the grip of the pike; and
2. simultaneously release the flag with a downward movement of the right hand.

This drill movement is also used on the commands:

- GENERAL SALUTE—SALUTE; and
- EYES—RIGHT during a march past (the flag is let fly on the next left foot).



Timing for this movement is one.

CATCH THE FLAG FROM THE LET FLY

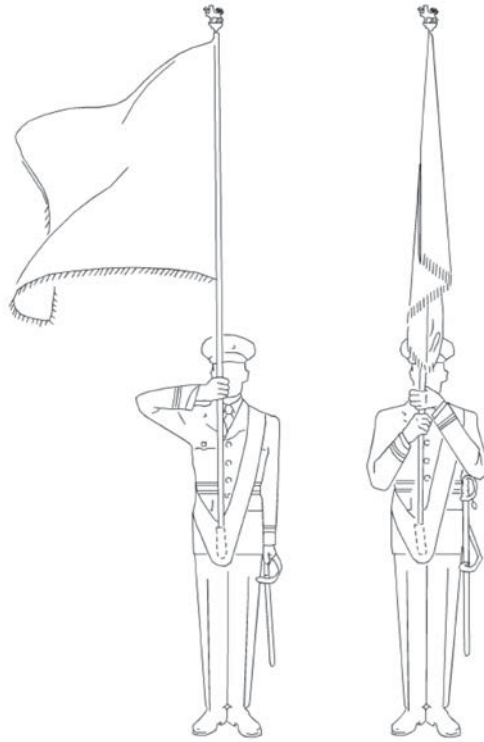

A-PD-201-000/PT-000 (p. 8-3-18)

Figure 8-3-11 Catch the Flag From the Let Fly

On the command, CATCH THE— FLAG(S), the cadets shall:

1. on the first movement:
 - (a) grasp the flag with the left hand and bring it in to the pike; and
 - (b) simultaneously, grasp the corner of the flag with the right hand, back of the hand outwards, at the point of the pike where the lowest corner of the flag reached; and
2. on the second movement, cut the left hand to the side to the position of attention and raise the right forearm to the horizontal position.

This drill movement is also used on the commands:

- ATTEN—TION following the General Salute; and
- EYES—FRONT during the march past.



Timing for this movement is one-two-three, one.



Depending on the wind direction, the flag may be grasped with the right hand after securing the pike in the left hand. If, because of wind strength, the flag cannot be caught, the flag shall be brought to the position of the order, the flag secured and returned to the carry.

CONFIRMATION OF TEACHING POINT 3

The cadets' practicing of carry from the order, order from the carry, let fly and catch the flag will serve as the confirmation of this TP.

Teaching Point 4

**Demonstrate, Explain and Have the Cadets Practice
Marching and Halting in Quick Time and Spiral
Countermarching With Flags**

Time: 35 min

Method: Demonstration and Performance

MARCHING AND HALTING IN QUICK TIME WITH FLAGS

On the command, QUICK—MARCH, the cadets shall:

1. shoot the left foot forward one half pace (35 cm [14 inches]), with the toe up;
2. strike the heel on the ground first and keep the toe pointed directly forward;
3. simultaneously, swing the left arm back waist high;
4. maintain the right arm in the position of the carry; and
5. continue to march with subsequent standard paces (75 cm [30 inches]).



Timing for this movement is left-right-left.

On the command, SQUAD—HALT, the cadets shall:

1. place the right foot flat on the ground naturally, using the heel as a brake;
2. simultaneously swing the left arm forward, breast-pocket high;
3. take a half pace (35 cm [14 inches]) with the left foot, placing it flat on the ground, swinging the left arm back;
4. bend the right knee and straighten it in double time; and
5. simultaneously, cut the left arm to the side as quickly as possible and assume the position of attention.



The command SQUAD—HALT is given as the left foot is on the ground.



Timing for this movement is one-one-two.



Practice the movements with:

- the **instructor** calling the time;
- the **squad** calling the time; and
- the squad **judging** the time.

Emphasize any movements that the cadets had difficulty with during the lesson.

SPIRAL COUNTERMARCHING WITH FLAGS

An adapted form of the spiral countermarch is used to reverse the direction that the flag party is facing without using as much space as is required for a double wheel by the flag party.

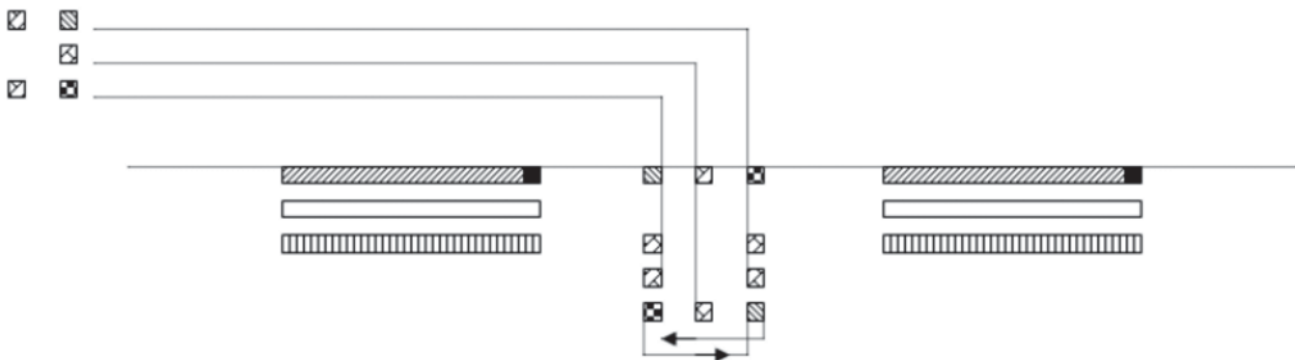

Director Cadets 3, 2008, Ottawa, ON: Department of National Defence

Figure 8-3-12 Spiral Countermarch

On the command, FLAG PARTY, SPIRAL COUNTER—MARCH:

1. all cadets shall maintain the same cadence;
2. the cadets in the file on the right shall perform two consecutive left wheel movements;
3. the cadets in the centre and the file on the left shall perform two consecutive right wheel movements; and
4. the escorts in the rear rank shall follow the flag bearer to their front into position while maintaining dressing.



It is recommended to end this lesson here and teach TPs 5 and 6 during a second session.

CONFIRMATION OF TEACHING POINT 4

The cadets' participation in practicing marching and halting, and spiral countermarching with flags will serve as the confirmation of this TP.

Teaching Point 5**Demonstrate, Explain and Have the Cadets Practice Forming to the Right and Left With Flags**

Time: 40 min

Method: Demonstration and Performance

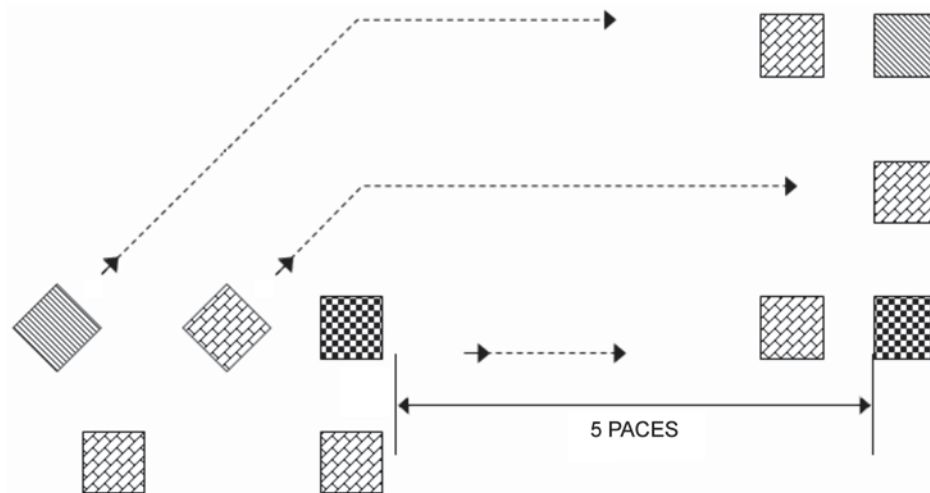

A form changes the direction faced by a flag party in line while maintaining its formation.

CHANGE DIRECTION BY FORMING AT THE HALT

Director Cadets 3, 2008, Ottawa, ON: Department of National Defence

Figure 8-3-13 Right Form

To change direction by forming at the halt to the halt, the following movements shall occur:

On the command AT THE HALT, CHANGE DIRECTION RIGHT (LEFT), RIGHT (LEFT)—FORM:

1. the leading person on the directing flank turns right (left);
2. simultaneously, the remainder of the front rank makes a right (left) incline; and
3. the rear ranks stand fast.

On the command QUICK—MARCH:

1. the leading person of the directing flank marches forward five paces and halts;
2. simultaneously, the remainder of the squad steps off, wheeling as necessary to regain their original position to the left (right) of the directing flank; and
3. each successive file halts in succession from right to left (left to right), facing the new direction.

CHANGE DIRECTION BY FORMING ON THE MARCH



The command CHANGE DIRECTION RIGHT (LEFT), RIGHT (LEFT)—FORM is given as the left (right) foot is on the ground.

To change direction by forming on the march, the following movements shall occur:

On the command CHANGE DIRECTION RIGHT (LEFT), RIGHT (LEFT)—FORM:

1. the leading person of the directing flank makes a right (left) turn, marches forward six paces and marks time;
2. simultaneously, the remainder of the front rank makes a right (left) incline and steps off toward the new position in line with the right (left) flag;
3. the remainder of the squad wheels as necessary to regain their original position to the left (right) of the directing flank; and
4. each successive file marks time, in succession from right to left (left to right), facing the new direction.

On the command FOR—WARD or FLAG PARTY—HALT, the squad acts as ordered.



The commands FOR—WARD and FLAG PARTY—HALT are given as the left foot is on the ground.



Practice the movements with:

- the **instructor** calling the time;
- the **squad** calling the time; and
- the squad **judging** the time.

Emphasize any movements that the cadets had difficulty with during the lesson.

CONFIRMATION OF TEACHING POINT 5

The cadets' practicing of change direction by forming at the halt and on the march will serve as the confirmation of this TP.

Teaching Point 6**Demonstrate, Explain and Have the Cadets Practice Marching On and Marching Off the Flags**

Time: 45 min

Method: Demonstration and Performance

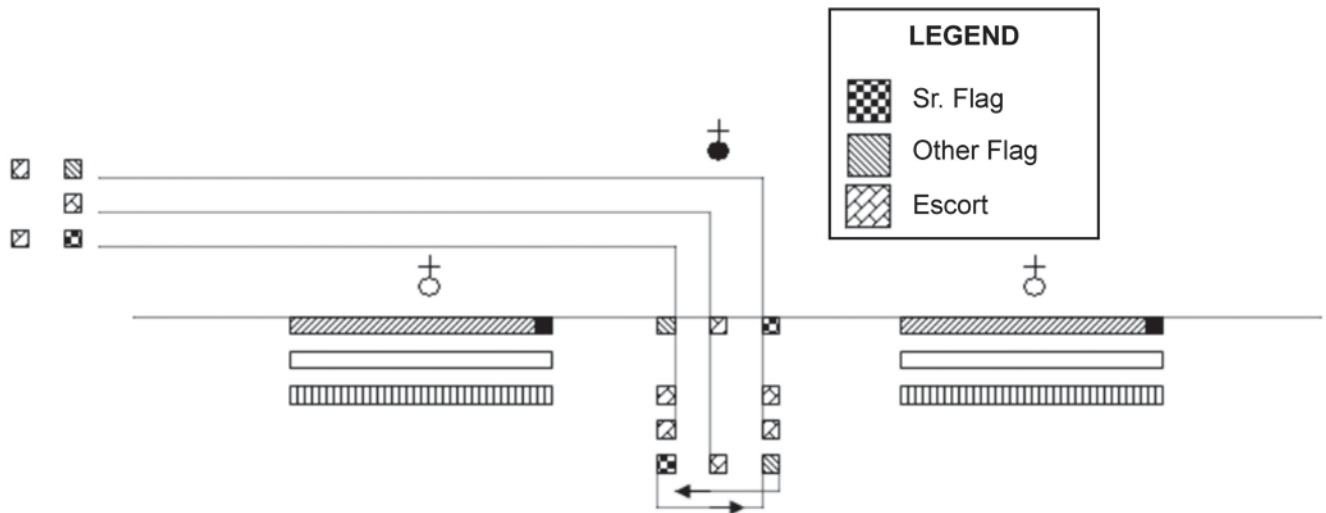

The flag party shall march on and march off the parade from the same flank, either left or right.

MARCHING ON THE FLAG(S)

Director Cadets 3, 2008, Ottawa, ON: Department of National Defence

Figure 8-3-14 March on the Flag(s) From the Left Flank

On the command, MARCH ON THE—FLAG(S), members of the flag party shall perform the following:

1. the flag party commander shall order the cautionary FLAG PARTY;
2. the parade commander shall order TO THE FLAG(S)—SALUTE; and
3. the flag party commander shall order BY THE RIGHT (CENTRE), QUICK—MARCH.

The flag party shall march to its position by a series of forms (as illustrated in Figure 8-3-14).

On the command, FLAG PARTY, SPIRAL COUNTER—MARCH:

The series of forms shall be conducted as follows:

1. On the command FLAG PARTY, QUICK—MARCH, the flag party shall move as a unit to a location on the parade square centred on the parade commander.
2. On the command FLAG PARTY, CHANGE DIRECTION RIGHT (LEFT), RIGHT (LEFT)—FORM, the flag party shall perform a right (left) form on the march. Upon completion of the form, the cadets shall mark time.
3. The flag party shall resume marching on the command FOR—WARD.
4. The flag party shall perform a spiral countermarch. On the command, FLAG PARTY, SPIRAL COUNTER—MARCH:

- (a) all cadets shall maintain the same cadence;
 - (b) the cadets in the file on the right shall perform two consecutive left wheel movements;
 - (c) the cadets in the centre and the file on the left shall perform two consecutive right wheel movements;
and
 - (d) the escorts in the rear rank shall follow the flag bearer to their front into position while maintaining dressing.
5. Upon completion of the spiral countermarch, the flag party shall move to a predetermined location on the parade square.
 6. Upon halting in its parade position, the flag party commander orders FLAG PARTY, TO THE FLAG(S)
—SALUTE.



If the flag party is armed, the flag party commander will order FLAG PARTY, TO THE FLAG(S), PRESENT—ARMS.

Once the flag escort is at the present, the parade commander will order SLOPE—ARMS, and the parade, now including the flag party will slope arms.

Until the flag party is ordered off at the conclusion of the parade, it shall execute the parade commander's commands rather than the flag party commander's commands, except in the following circumstances:

- During an inspection, the flag shall remain in the carry position when the parade commander orders the squadron AT—EASE.
- When required to move to a flank independently, the flag party shall do so under command of its flag party commander by executing forms at the halt or on the march.

MARCHING OFF THE FLAG(S)

On the command, MARCH OFF THE—FLAG(S), members of the flag party shall perform the following:

1. the flag party commander shall order the cautionary FLAG PARTY;
2. the parade commander shall order TO THE FLAG(S)—SALUTE; and
3. the flag party commander shall order BY THE RIGHT (CENTRE), QUICK—MARCH.

The series of forms shall be conducted as follows:

1. On the command FLAG PARTY, QUICK—MARCH, the flag party shall move as a unit to a location on the parade square centred on the parade commander.
2. On the command FLAG PARTY, CHANGE DIRECTION LEFT (RIGHT), LEFT (RIGHT)—FORM, the flag party shall perform a left (right) form on the march. Upon completion of the form, the cadets shall mark time.
3. The flag party shall resume marching on the command FOR—WARD.
4. The flag party shall move to the left (right) flank and march off the parade square.

CONFIRMATION OF TEACHING POINT 6

The cadets' participation in practicing marching on and off as members of a flag party will serve as the confirmation of this TP.

END OF LESSON CONFIRMATION

Have the cadets execute flag drill on the march while judging the time.

Continue delivering commands as time allows, focusing on movements with which the cadets experience difficulty.

CONCLUSION

HOMEWORK/READING/PRACTICE

N/A.

METHOD OF EVALUATION

N/A.

CLOSING STATEMENT

Flag drill is the foundation for all other flag drill movements. Drill develops many qualities through self-discipline and practice. Drill that is well-rehearsed, closely supervised and precise is an exercise in obedience and alertness that creates teamwork.

INSTRUCTOR NOTES/REMARKS

It is recommended that this lesson be conducted in two separate sessions. Conduct TPs 1 to 4 in the first session and TPs 5 and 6 in the second session.

Squadrons wishing to deviate from the lesson structure for local/Air Force traditions may do so, but are limited to the six periods allocated.

REFERENCES

- | | |
|--------|--|
| A0-002 | A-PD-201-000/PT-000 Director History and Heritage 3-2. (2005). <i>The Canadian Forces Manual of Drill and Ceremonial</i> . Ottawa, ON: Department of National Defence. |
| A0-031 | A-PD-202-001/FP-000 Director Ceremonial 2. (1993). <i>Canadian Forces Military Bands and Marches: Band Instructions</i> . Ottawa, ON: Department of National Defence. |
| A0-099 | A-AD-200-000/AG-000 Director History and Heritage. (1999). <i>The Honours, Flags and Heritage Structure of the Canadian Forces</i> . Ottawa, ON: Department of National Defence. |
| A0-102 | Director Cadets 5. (1999). CATO 12-05, <i>Cadet Flags and Banners</i> . Ottawa, ON: Department of National Defence. |

THIS PAGE INTENTIONALLY LEFT BLANK



COMMON TRAINING
PROFICIENCY LEVEL THREE
INSTRUCTIONAL GUIDE



SECTION 4
EO C308.02 – DELIVER WORDS OF COMMAND

Total Time:

60 min

PREPARATION

PRE-LESSON INSTRUCTIONS

Resources needed for the delivery of this lesson are listed in the lesson specification located in A-CR-CCP-803/PG-001, Chapter 4. Specific uses for said resources are identified throughout the instructional guide within the TP for which they are required.

Review the lesson content and become familiar with the material prior to delivering the lesson.

Photocopy, cut out, fold and laminate the aide-mémoire cards with the words of command located at Annex C for each cadet.

PRE-LESSON ASSIGNMENT

N/A.

APPROACH

A practical activity was chosen for this lesson as it is an interactive way to allow the cadets to experience delivering words of command in a safe, controlled environment.

INTRODUCTION

REVIEW

The review associated with this lesson is from EO M308.02 (Deliver Words of Command, Section 2), to include:

QUESTIONS

- Q1. Why are cautionary commands given?
- Q2. What is the purpose of the executive command?
- Q3. If a command is not pronounced clearly and distinctly, what affect may it have on the squad being commanded?
- Q4. How does poor posture affect delivering commands?

ANTICIPATED ANSWERS

- A1. To warn the squad that a movement will be performed.
- A2. To signal that the movement is to be carried out.
- A3. Cadets may not understand the command and perform the wrong movement.
- A4. It restricts the ability to breathe deeply, restricting the movement of the diaphragm, which will cause commands to come from the throat.

OBJECTIVES

By the end of this lesson the cadet shall have delivered words of command.

IMPORTANCE

It is important for cadets to know how to deliver words of command, as words of command that are delivered in a clear, concise manner, with confidence and determination, will affect how cadets respond to orders. Words of command are required to move a flight in an organized and efficient manner.

Teaching Point 1

Demonstrate and Have the Cadets Practice Delivering Words of Command

Time: 50 min

Method: Practical Activity

ACTIVITY

OBJECTIVE

The objective of this activity is for each cadet to practice delivering words of command.

RESOURCES

Aide-mémoire cards located at Annex C.

ACTIVITY LAYOUT

N/A.

ACTIVITY INSTRUCTIONS

1. Demonstrate delivering words of command.
2. Distribute the aide-mémoire cards to each cadet.
3. Divide the cadets into groups of no more than four cadets.
4. Have each cadet, within their group, practice delivering words of command with emphasis on voice, accuracy, confidence, correct posture and breathing control. Have the cadets practice commands at the halt and on the march with the other members of the group acting as the squad. Each cadet will be allotted approximately 10 minutes in front of their group.
5. Circulate among the groups and assist the cadets as necessary, offering suggestions and advice for improvement.

SAFETY

N/A.

CONFIRMATION OF TEACHING POINT 1

The cadets' participation in the activity will serve as the confirmation of this TP.

END OF LESSON CONFIRMATION

The cadets' participation in delivering words of command will serve as the confirmation of this lesson.

CONCLUSION

HOMEWORK/READING/PRACTICE

N/A.

METHOD OF EVALUATION

N/A.

CLOSING STATEMENT

When words of command are delivered in a clear and concise manner and with confidence and determination, it will affect how cadets respond to the order. Delivering words of command can allow a flight to move as a team in an organized and efficient manner as all members learn to work together.

INSTRUCTOR NOTES/REMARKS

Cadets shall be provided the opportunity to deliver words of command and be given feedback during weekly opening and closing parades, and ceremonial parades.

This EO will be used as additional practice time for EO M308.02 (Deliver Words of Command, Section 2).

REFERENCES

N/A.

THIS PAGE INTENTIONALLY LEFT BLANK

DRILL SEQUENCE HANDOUT (PREPARING A FLIGHT FOR PARADE)

Flight in Line

When a flight is formed in line, the team leader, assuming the role of the SWO, shall be positioned three paces in front and centred on the flight.

Steps to Preparing a Flight for Parade

The steps to preparing a flight for parade include:

1. The flight shall form up in three ranks at the edge of the parade square and stand at ease.
2. The team leader shall carry on with forming up a flight as detailed below.

Item	Command	Given By	Execution	Observation
a.		Team Leader	The Team Leader shall march to a position three paces in front of, and facing, the position the marker is to occupy.	The flight is formed up just off the parade square, standing easy. The right hand cadet of the front rank is the designated "Marker".
b.	MARKER	Team Leader	The Marker shall come to attention, answer by rank, observe the standard pause, march in a direct line to, and halt three paces in front of and facing, the Team Leader. The Marker shall remain at attention.	The flight shall come to the position of stand at ease. The Team Leader, after placing the Marker, shall turn right and march to a position three paces in front of and centre facing where the flight shall fall in.
c.	FLIGHT FALL—IN	Team Leader	The flight shall come to attention, observe the standard pause and march onto the parade ground. It shall halt on the left of and covering off the marker and remain at attention.	A direct route shall be taken by the flight.

3. The team leader shall carry on with calling the roll as detailed below.

Item	Command	Given By	Execution	Observation
a.	ANSWER TO YOUR NAME, STAND AT—EASE	Team Leader	Each flight member shall come to attention as their name is called, answer accordingly and stand at ease.	The team leader shall read each name from a roll and mark the attendance for each cadet.

4. The team leader shall carry on with sizing in a single rank and reforming threes (twos) as detailed below.

Item	Command	Given By	Execution	Observation
a.	TALLEST ON THE RIGHT, SHORTEST ON THE LEFT, IN A SINGLE RANK—SIZE	Team Leader	The flight shall turn right, observe the standard pause, then arrange themselves according to height, with tallest on the right and shortest on the left in one single rank, shoulder to shoulder dressing and covering off front to rear.	The team leader shall ensure the cadets are arranged as ordered before proceeding.
b.	FLIGHT—NUMBER	Team Leader	The flight shall call out their number in sequence from the right.	The team leader shall ensure that no numbers are missed.
c.	ODD NUMBERS ONE PACE FORWARD, EVEN NUMBERS ONE PACE STEP BACK—MARCH	Team Leader	The flight shall act as ordered.	
d.	NUMBER ONE STAND FAST, ODD NUMBERS RIGHT, EVEN NUMBERS LEFT—TURN	Team Leader	The flight shall act as ordered.	
e.	REFORM THREES (TWS), QUICK—MARCH	Team Leader	The flight reform ranks with Number 1 as the marker and remainder filling in the next open position.	When each person arrives in their new position, they shall halt, at arm's-length interval, observe the standard pause, turn left and remain at attention.

5. The team leader shall carry on with dressing a flight as detailed below.

Item	Command	Given By	Execution	Observation
a.	RIGHT—DRESS	Team Leader	The flight shall act as ordered.	
b.	EYES—FRONT	Team Leader	The flight shall act as ordered.	

6. The team leader shall carry on with inspecting a flight as detailed below.

Item	Command	Given By	Execution	Observation
a.	OPEN ORDER— MARCH	Team Leader	The flight shall act as ordered.	
b.	RIGHT—DRESS	Team Leader	The flight shall act as ordered.	
c.	EYES—FRONT	Team Leader	The flight shall act as ordered.	
d.		Team Leader	The team leader will inspect the front and rear of each cadet, starting at the right marker and proceeding around each rank in turn. The inspection of a cadet shall start at the head and work down to the feet.	The purpose of an inspection is to ensure a standard of personal hygiene and grooming, and that each cadet is properly dressed, with all clothing, badges, etc, are worn correctly, clean, and in good repair.
e.	CLOSE ORDER— MARCH	Team Leader	The flight shall act as ordered.	
f.	RIGHT—DRESS	Team Leader	The flight shall act as ordered.	
g.	EYES—FRONT	Team Leader	The flight shall act as ordered.	
h.	STAND AT— EASE	Team Leader	The flight shall act as ordered.	

7. As the flight commander approaches, the team leader shall carry on with handing over a flight as detailed below.

Item	Command	Given By	Execution	Observation
a.	ATTEN—TION	Team Leader	The flight shall act as ordered.	The team leader calls the flight to attention as the flight commander approaches.
b.		Team Leader		The flight commander halts two paces in front of the team leader, who reports the flights strength and condition.
c.		Team Leader		Upon being ordered to fall in, the team leader turns right, by a series of wheels proceeds around the right flank and takes their position behind the flight.
d.		Flight Commander		The flight commander marches forward two paces to take up their position.

AIDE-MÉMOIRE CARD – PREPARING A FLIGHT FOR PARADE



PREPARING A FLIGHT FOR PARADE

FALLING IN:

- MARKER.
- FLIGHT FALL—IN.

CALLING THE ROLL:

- ANSWER TO YOUR NAME, STAND AT—EASE.

SIZING IN A SINGLE RANK:

- TALLEST ON THE RIGHT, SHORTEST ON THE LEFT, IN A SINGLE RANK—SIZE.
- FLIGHT—NUMBER.
- ODD NUMBERS ONE PACE FORWARD, EVEN NUMBERS ONE PACE STEP BACK—MARCH.
- NUMBER ONE STAND FAST, ODD NUMBERS RIGHT, EVEN NUMBERS LEFT—TURN.
- REFORM THREES (TWOS), QUICK—MARCH.

DRESSING:

- RIGHT—DRESS.
- EYES—FRONT.

PRE-INSPECTING:

- OPEN ORDER—MARCH.
- RIGHT—DRESS.
- EYES—FRONT.

POST-INSPECTING:

- CLOSE ORDER—MARCH.
- RIGHT—DRESS.
- EYES—FRONT.
- STAND AT—EASE.

HANDING OVER:

- ATTEN—TION.



PREPARING A FLIGHT FOR PARADE

FALLING IN:

- MARKER.
- FLIGHT FALL—IN.

CALLING THE ROLL:

- ANSWER TO YOUR NAME, STAND AT—EASE.

SIZING IN A SINGLE RANK:

- TALLEST ON THE RIGHT, SHORTEST ON THE LEFT, IN A SINGLE RANK—SIZE.
- FLIGHT—NUMBER.
- ODD NUMBERS ONE PACE FORWARD, EVEN NUMBERS ONE PACE STEP BACK—MARCH.
- NUMBER ONE STAND FAST, ODD NUMBERS RIGHT, EVEN NUMBERS LEFT—TURN.
- REFORM THREES (TWOS), QUICK—MARCH.

DRESSING:

- RIGHT—DRESS.
- EYES—FRONT.

PRE-INSPECTING:

- OPEN ORDER—MARCH.
- RIGHT—DRESS.
- EYES—FRONT.

POST-INSPECTING:

- CLOSE ORDER—MARCH.
- RIGHT—DRESS.
- EYES—FRONT.
- STAND AT—EASE.

HANDING OVER:

- ATTEN—TION.

THIS PAGE INTENTIONALLY LEFT BLANK

AIDE-MÉMOIRE CARD – PREPARING A SQUAD FOR PARADE



PREPARING A SQUAD FOR PARADE

FALLING IN:

- MARKER.
- SQUAD FALL—IN.

CALLING THE ROLL:

- ANSWER TO YOUR NAME, STAND AT—EASE.

SIZING IN A SINGLE RANK:

- TALLEST ON THE RIGHT, SHORTEST ON THE LEFT, IN A SINGLE RANK—SIZE.
- SQUAD—NUMBER.
- ODD NUMBERS ONE PACE FORWARD, EVEN NUMBERS ONE PACE STEP BACK—MARCH.
- NUMBER ONE STAND FAST, ODD NUMBERS RIGHT, EVEN NUMBERS LEFT—TURN.
- REFORM THREES (TWOS), QUICK—MARCH.

DRESSING:

- RIGHT—DRESS.
- EYES—FRONT.

PRE-INSPECTING:

- OPEN ORDER—MARCH.
- RIGHT—DRESS.
- EYES—FRONT.

POST-INSPECTING:

- CLOSE ORDER—MARCH.
- RIGHT—DRESS.
- EYES—FRONT.
- STAND AT—EASE.

HANDING OVER:

- ATTEN—TION.



PREPARING A SQUAD FOR PARADE

FALLING IN:

- MARKER.
- SQUAD FALL—IN.

CALLING THE ROLL:

- ANSWER TO YOUR NAME, STAND AT—EASE.

SIZING IN A SINGLE RANK:

- TALLEST ON THE RIGHT, SHORTEST ON THE LEFT, IN A SINGLE RANK—SIZE.
- SQUAD—NUMBER.
- ODD NUMBERS ONE PACE FORWARD, EVEN NUMBERS ONE PACE STEP BACK—MARCH.
- NUMBER ONE STAND FAST, ODD NUMBERS RIGHT, EVEN NUMBERS LEFT—TURN.
- REFORM THREES (TWOS), QUICK—MARCH.

DRESSING:

- RIGHT—DRESS.
- EYES—FRONT.

PRE-INSPECTING:

- OPEN ORDER—MARCH.
- RIGHT—DRESS.
- EYES—FRONT.

POST-INSPECTING:

- CLOSE ORDER—MARCH.
- RIGHT—DRESS.
- EYES—FRONT.
- STAND AT—EASE.

HANDING OVER:

- ATTEN—TION.